



FREE: Khomeini Pistol Targets

CDC 00199
USA \$2.25
MARCH/1980

SOLDIER OF FORTUNE

The Journal Of Professional Adventurers

**Exclusive:
Anti-
Terrorist
Strike into
Mozambique!**

**West
Germany's
GSG 9:
Armed and
Ready**



Will the U.S. Army Fight?

A. .45 CAL. PISTOL, REPLICA. Will not fire. (Not deliverable to NYC or Quebec, Canada addresses.) S07-1035 \$46.50 ppd

B. HOLSTER, SHOULDER for .45 cal. pistol. G.I. S05-1005 \$23.50 ppd

C. WOOL NECK SCARF. S05-1069 \$4.75 ppd

D. ALICE RUCKSACK with frame, complete. S05-1082 \$99.75 ppd

E. TANKER JACKET, O.D. Sizes S-M-L-XL. S01-1029 Nylon \$29.50 ppd
S01-1030 Cotton Sateen. 29.50 ppd

F. SLEEPING BAG, DOWN FILLED. S05-1110 Nylon. \$82.25 ppd
S05-1111 Cotton 79.75 ppd
S05-1014 Cover, Used... 7.50 ppd

G. FATIGUES, CERTIFIED. Perma-press. Shirts S-M-L-XL. pants 28-42; lengths of 31 and 33. S01-1002 Shirts \$12.50 ppd
S01-1003 Pants 12.50 ppd

H. TROUSER BLOUSERS. Hook style. S01-1200 \$7.50 ppd

J. TANKER BOOTS. Leather with straps. Sizes 6-13 in regular and wide. S03-1016 \$54.50 ppd

K. HELMET COVER, rip-stop camouflage. S05-1190 \$3.25 ppd

L. ELASTIC BANO for camouflage cover. Used, marked. S05-1235 \$1.00 ppd

M. STEEL HELMET. Steel pot only. Used. S05-1236 \$7.00 ppd

N. HELMET LINER. Used, without sweatband. S05-1092 \$6.75 ppd
S05-1058 Sweatband 2.00 ppd

P. FACE PAINT, CAMOUFLAGE. Two tubes in .45 canvas case. S05-1031 \$3.75 ppd

Q. M-16 BAYONET with scabbard. New, genuine S07-1242 \$28.50 ppd

R. M-16 RIFLE, REPLICA. Will not fire. (Not deliverable to NYC or Quebec, Canada addresses.) S05-1237 \$169.50 ppd

S. SLING, M-16. Silent model. S05-1201 \$3.00 ppd

T. MARK II GERBER KNIFE. Black leather scabbard, complete. S07-1120 \$49.50 ppd

U. TACTICAL WATCHBAND. O.D. nylon with velcro. State wrist size. S05-1221 \$4.75 ppd

V. LC-1 SUSPENDERS. Nylon. Adjustable. S05-1121 \$12.50 ppd

W. ENTRENCHING TOOL WITH COVER. ER. All genuine U.S. Folds. S05-1191 \$29.75 ppd

X. M-16, 30CAL. MAGAZINE POUCH. For 20-round magazine. S05-1199 \$12.50 ppd

Y. CANTEEN WITH COVER. Nylon cover, U.S. plastic canteen. S05-1120 \$7.75 ppd

Z. PISTOL BELT, O.O. Adjustable, genuine. S05-1044 \$9.75 ppd

AA. BLACK LEATHER GLOVE SHELLS. D3A, U.S. issue, Sizes 3, 4 and 5. S04-1044 \$9.75 ppd

BB. WOOL GLOVE LINERS. D3A olive drab. Sizes 3, 4, and 5. S04-1045 \$3.25 ppd

CC. FATIGUES, CAMOUFLAGE, CERTIFIED. Genuine, new. Sizes XS-S-M-L. Set only. S05-1024 \$49.50 ppd

CC. JUNGLE BOOTS. Genuine issue. Made in U.S.A. Sizes 6-13 in regular and wide. No 1/2 sizes. Panama sole. S03-1014 \$46.50 ppd



MILITARY SUPPLIES

COMPLETE SELECTION IN OUR 152 PAGE FULL COLOR 1980 CATALOG OF HARD-TO-FIND MILITARY ITEMS AND ACCESSORIES. TO RECEIVE YOUR COPY, SEND \$2.00 TO:

U.S. CAVALRY STORE, Inc.

1375 North Wilson Road
Radcliff, Kentucky 40160 U.S.A.

For Fastest Service on Charge Card Orders, Call
(502) 351-1164

AND ASK FOR "SERVICE TODAY!"

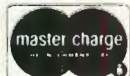

CATALOG SENT AT NO CHARGE WITH EACH ORDER PLACED. MINIMUM PURCHASE: \$10.00



WANTED!

FOR
THE CRIME OF
IMPERSONATING
A HOLY MAN

REWARD!
\$1.98



**SOLDIER
OF
FORTUNE
MAGAZINE**

© 1979 Copyright by
Soldier of Fortune Magazine

PHOENIX

G



H



T-SHIRTS
\$6.95 each

These T-shirts are 100% cotton.
Order today
MONEY BACK GUARANTEE.
ALLOW 3-4 WKS. FOR DELIVER.
ADD \$1.00 FOR POSTAGE AND
HANDLING.

I



J



VISA
Mastercharge

Overseas Orders add 20%
Colo. Residents add 3%
P.O. Box 693,
Boulder, Colorado 80306



THE VIETNAM WAR:

An Illustrated
History of the Conflict
in Southeast Asia

By Bernard C. Nalty

Forward by

General William Westmoreland

This extensive and impressive volume provides an objective analysis of the conflict in Southeast Asia. It offers a vivid battle-by-battle analysis of tactics and strategies and a directory of the military equipment employed. Dramatic, heavy-impact photographs, many never before published, document the text throughout.

It begins with France's attempt to regain control of its possessions in the region. Next is the story of increasing Viet Cong involvement and the escalation of hostilities, the full story of American involvement, Vietnamization and reduction in American strength, the end of hostilities, and finally the establishment of Communist governments.

Each victory, each defeat, is examined technically, with an appraisal of the tactics and the major weapons used by the combatants.

Photographs in color and black and white, technical drawings, maps, diagrams, and straight, clear text make this the most important and comprehensive military story of the Southeast Asian conflict.

370 illustrations including 250 color photographs, black-and-white photographs, technical drawings, maps, and diagrams.

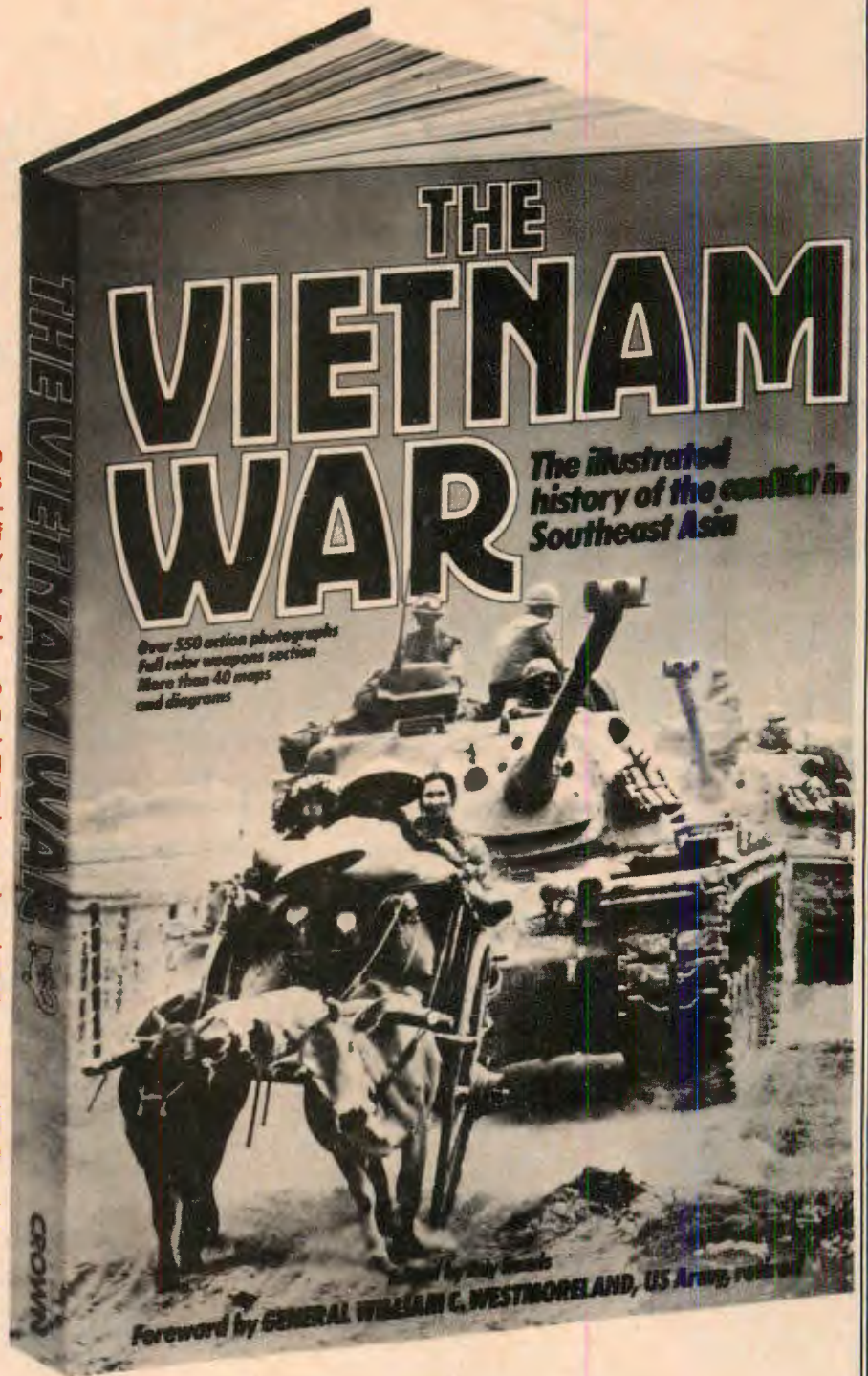

THE VIETNAM WAR

SOLDIER OF FORTUNE
BOX 693, BOULDER, CO 80306

Enclosed is \$17.95 per copy plus
\$1.75 for postage and handling.
Please send _____ book(s). Colo-
rado residents add 3½ % sales tax.

Name _____

Address _____

City _____

State _____ Zip _____

DESERT PUBLICATIONS

NEW BOOKS!

Combat Bookshelf

BROWN'S ALCOHOL MOTOR FUEL COOKBOOK

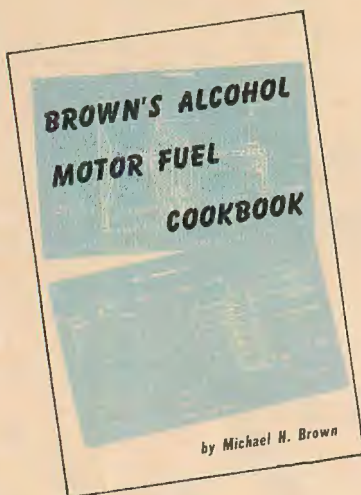

by Michael H. Brown

This exciting new title contains all the information for producing and using alcohol as a motor fuel. Step-by-step procedures for the modification of an average car's carburetor to run on alcohol, with large clear photographs and drawings. Information on how to modify a car's engine and carburetor to get 100 miles per gallon on alcohol. How to build your own moonshine still, from a small experimental type, producing several gallons a day, to a very large still capable of producing 100's of gallons a day. You will be amazed at how simple the modifications are and how easy it is to produce your own alcohol motor fuel. Alcohol makes an excellent motor fuel. Alcohol burns clean, thus would protect our fragile environment from needless pollution. This is a very real answer to a very questionable energy shortage. Don't hesitate to get your copy today. For far less than a tank full of gas, you can be gasoline independent.

300. \$9.95

TECHNIQUES OF HARASSMENT VOL. II — A Step Beyond — by George Carpenter

The overnight success of Vol. I demanded the subject be continued further. George Carpenter begins where Santoro left off. Truly a post-graduate work in the area of dirty tricks. How to turn every night into a Halloween nightmare for your targeted opponent. This new volume together with Vol. I does for the average "good guy" what the Colt .45 did for our forefathers. In this context we borrow from Colt's original inscription: "Fear no man regardless of size — with "Techniques of Harassment" you can equalize." 214, Vol. II \$4.95

TAKE MY GUN — IF YOU DARE by Morgan Norval

A dynamite new book that approaches the subject of the right to own and bear arms from a refreshing new direction. The chapters include: The Right to Life; Origins of the Use of Weapons in Self-Defense; Legal Aspects of Self-Defense; Why Not Registration?; Gun Control by Decree; BATF - The American Gestapo; Why Congress Isn't Enough; Don't Trust the Courts; Defend Gun Rights - The Final Step. Must reading for every concerned American. Hard cover. 551. \$8.95

INVISIBLE WEAPONS by Harold J. Jenks & Michael H. Brown

Another great new title from the guys who brought you "Bloody Iron." Not just another "improvised" weapons book, but a new look at some of the social and political happenings in the USA that parallel other countries, such as Okinawa, where "invisible weapons" became a way of life. Many how-to-do-it ideas are presented whereby common, everyday items can be utilized as lethal weapons. Well illustrated with many photographs. 429. \$6.95

THE SHOTGUN IN COMBAT by Tony Lesce

Finally, a comprehensive study into the use of a shotgun in combat situations. A one-stop source of vital information including: A Brief History of the Shotgun; Shotgun Ballistics; Silencers; "Dutch" Loads; Poisoned Loads; Test Your Ammo for Reliability; Improved Loads for the Shotgun; Hiding a Shotgun; Shotgun Wounds; Preparing for Combat; The Scenario Method; Devising Your Own Scenarios; Using the Shotgun in Combat; plus much, much more! 430. \$4.95

HOME WORKSHOP GUNS FOR DEFENSE AND RESISTANCE VOL. II, THE HANDGUN

by Bill Holmes 11 12 13 14 15 16 17

Now available, the complete home workshop guide to making your own handgun. Offered are two complete firearms designs, one for a semi or full automatic pistol, the other for a single shot, falling block handgun. As with the first volume in this series, the author has written in a clear, simple style. 5 1/2 x 8 1/2, softcover, photos and diagrams. 134 pp. HWG-2 \$6.00

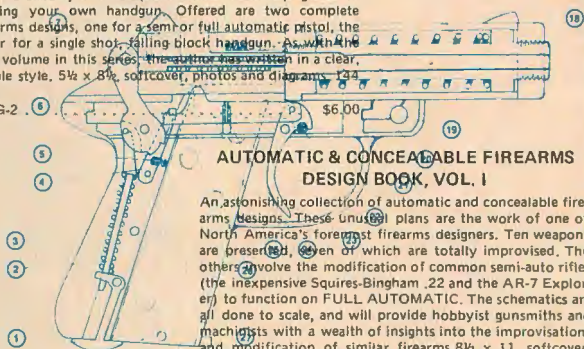

AUTOMATIC & CONCEALABLE FIREARMS DESIGN BOOK, VOL. I

An astonishing collection of automatic and concealable firearms designs. These unusual plans are the work of one of North America's foremost firearms designers. Ten weapons are presented, seven of which are totally improvised. The others involve the modification of common semi-auto rifles (the inexpensive Squires-Bingham .22 and the AR-7 Explorer) to function on FULL AUTOMATIC. The schematics are all done to scale, and will provide hobbyist gunsmiths and machinists with a wealth of insights into the improvisations and modification of similar firearms. 8 1/2 x 11, softcover, diagrams, 32 pp. ACF \$12.00

DESERT PUBLICATIONS

Dept. SF Cornville, AZ 86325

Name _____
 Address _____
 City _____ State _____ Zip _____
 TITLE or BOOK No. _____

 Total _____



If you wish to add this purchase to your:
 — MASTER CHARGE, VISA or BANKAMERICARD —
 Include card number, expiration date and signature on separate paper and mail in with order. (If Master Charge also include the 4 digit number below your name).



Duel in the skies!

Relive the deadly dogfights...
raging air attacks...death-defying
bomb runs...blazing wartime action on
land, sea, and in the air, through this
outstanding collection of military books.

FINAL ENTRIES 1945 THE DIARIES OF JOSEPH GOEBBELS
0687 \$14.95

WAKE ISLAND
3269 \$8.95

SAMURAI!
1610

Medieval Warfare
6585 \$12.95

THE ARMS BAZAAR FROM GRENADA TO LOCKHEED
4028 \$12.95

AN UNCOMMON HISTORY OF THE AMERICAN REVOLUTION
2154 \$12.50

MAKE THE KAISER DANCE
2964 \$10.95

SILENT VICTORY
5629 \$25.75

COMMANDOS AND RANGERS OF WORLD WAR II
1602 \$12.95

PATTON
453 \$8.95

THE MIDNIGHT WAR
4077 \$14.95

POINT OF NO RETURN
2949 \$12.50

WAR IN THE PACIFIC
2972 \$12.50

THE UNKNOWN WAR
1883

FORTRESS
7013 \$15.00

WORLD WAR II YEARS
1834 \$12.50

GERMAN TANKS
1529 \$24.95

NAPOLEON THE LAST CAMPAIGNS 1812-15
3301 \$12.95

A PICTORIAL HISTORY OF THE SS 1923-1945
5702 \$14.95

SIGNAL YEARS OF TRIUMPH 1940-42
1446 \$12.95

AIRWAR
9134 \$39.80

U-BOAT WAR
0711 \$17.50

THE THIRD WORLD WAR AUGUST 1985
1917 \$12.95

The British at the Gates
3731 \$10.00

Choose 4 books for only 98¢ with membership.

One moment you're settling into a comfortable chair in your home...and the next, you're 4,000 feet above the French countryside, squeezing off death-dealing bursts of 50mm rounds at a screaming Focke-Wulf 190.

Now you can enjoy hour after hour of heart-pounding wartime action through the Military Book Club's outstanding collection. These books will put you in the pilot's seat for do-or-die dogfights...you'll get your feet wet at daring beachhead invasions...you'll whiff gunpowder on grueling week-long infantry assaults...and huddle behind the scenes where life-and-death command decisions are being made before your eyes.

How the Club works.

After your membership's accepted, you'll receive your four books for 98¢ plus shipping and handling. If you are not satisfied, return them within 10 days, cancel your membership, and you owe nothing.

Once you've purchased just four books during your first two years of membership you may resign at any time.

About every four weeks (14 times a year) you'll receive, free, the Club's magazine describing the coming selection and alternates, which save you up to 30% off publishers' edition prices.

If you want the selection, do nothing, it will be shipped to you automatically. If you want an alternate, or no book at all, indicate your preference on the order form and return it by the date specified. That date allows you 10 days to decide. If you receive an unwanted selection because you had less than 10

days, return it at our expense. There is a shipping and handling charge on all books shipped.

The Military Book Club offers its own complete, hardbound editions sometimes altered in size to fit special presses and save members even more.

Note: Prices shown are publishers' edition prices.

**FREE! When you join.
2 Giant Full-Color
World War II Strategy Maps**



Military Book Club

Dept. WR-226, Garden City, NY 11530

Please accept my application for membership in the Military Book Club and send me the four books whose numbers I have printed in the boxes below. Bill me only 98¢ plus shipping and handling. I understand that I need buy only four more books at regular low Club prices during the first two years of my membership to complete my purchase commitment. My membership will be subject to the terms and conditions presented in this ad. Also send me the two free WWII Strategy Maps, mine to keep whether or not I remain a member.

No-risk guarantee: If not delighted after examining my four selections, I may return the books within 10 days, and my membership will be canceled. I may keep the two WWII Strategy Maps, and I will owe nothing.

Note: If you select 2-volume AIRWAR set, write 9134 in 2 boxes, then choose 2 more selections.

--	--	--	--

Mr. _____
Mrs. _____
Miss _____
Address _____ Apt. No. _____
City _____

State _____ Zip _____
Members accepted in U.S.A. and Canada only. Canadian members will be serviced from Toronto. Offer slightly different in Canada. 04-M156

Sentinel Arms Co.

Offers Mini 14 conversion Parts!



Flash Hider
w/military sights
\$29.50

Military style
vent Handguard
\$37.50

Bipos Assy.
(Folds under gun when
not in use)
\$42.95

High Quality Paratrooper
Fold Stock Assy. **\$84.55**
(Installed by us on your stock)

or
Also available as a complete
unit on new stock. **Add \$40.00**



Smoke

- Manufactured by Smith & Wesson
- 3 Sec. fuze delay
- Top quality

\$34.10
(set of 3)

Grenades

Tear gas grenades same as above,
but contains CN or CS gas (set of 3)

\$42.50

"Night Site"

Aimpoint Electronic Scope
(Shown On Mini 14 Above)

Limited Supply
\$168.00
Order Now

- 500-1,000 Hrs. operation on 1 set of batteries.
- Rhoestate infinite adjustment for light intensity.
- Effective in low level light situations.
- Solid mount attaches to Weaver bases.
- Fully guaranteed by swiss mfr.

FULL AUTO FANS: CONVERT your AR-15 to full auto! No "Rip off" gimmick to "file sear" etc. Our kit contains all six parts necessary to change your AR to selective fire. Some minor machining necessary to install auto sear. **Parts Kit Instruction \$140**

Don't feel like machining for auto sear, or want to be able to limit your gun to semi only by quick removal of sear? Our drop in auto sear eliminates all machining, and removes in seconds **\$65.00**

NOTE: Check your local and state laws. . . It is illegal to remanufacture your gun into a machine gun without first obtaining permission from A.T.F. — When ordering kit we will send blank forms at no charge, if requested. Do it legal and sleep nights!

SOF'ers: Finding it hard to get the specialized guns you want? Tired of getting a blank stare or hearing "What anyone want sometin' like that for?" When you inquire about that rapid firing gun no "civilized" hunter would be caught dead with?

SENTINEL ARMS HAS THE ANSWER!

A.T.F. regulations allow you to buy the guns you want directly from the dealer with the best selection and most reasonable prices! Regardless of what state you live in, you can now purchase in person, or by mail that "hard to find" weapon direct from Sentinel Arms Co. We will then ship your firearm to a dealer in your area for delivery to you! This process takes only several days, except for full auto weapons, where in some state residents are not allowed ownership at all. (Check your local laws). Write or call for RAPID Service and Low Price!

SENTINEL ARMS CO.

17 Olmstead Plaza
Middletown, PA 17057
Phone: (717) 944-1614.



PA RESIDENTS: Our new retail store at 1285 Manheim Pike (Rt 72) opens in Lancaster, Penn. in late Sept. Stop in and see our large inventory of handguns, rifles and sporting goods. A copy of this ad gets you a FREE shooters bible. Sentinel Arms Co.'s amphibious tank will be on display at front of store — Register for free ride during opening days!

NOTE: Orders now being taken for Sentinel Arms' Combat .44 mag. As shown FIRST in SOF Issue Oct., 1979. Production is limited to 450, so reserve your serial number NOW. This special production gun is trimmed down versions of the Smith & Wesson Model 29, and features:

- 2½" BBL
- Round butt
- "Stainless" metalife finish
- Maggna Port
- Light trigger pull
- Special markings & serial numbers 001 thru 450
- Pachner grips
- Overall size just slightly larger than S&W Mod. 19 2½"

BRASS CATCHERS

\$37.50 \$30.50 — AR-15

\$42.50 \$35.50 — AR-180

Thanks to large volume of orders, we are able to **REDUCE** the price of our brass catchers.

EDITOR/PUBLISHER

Robert K. Brown

MANAGING EDITOR

Robert Poos

SENIOR EDITOR

M. L. Jones

ASSOCIATE EDITORS

N. E. MacDougald

S. Nielsen

Jim Graves

ART DIRECTOR

Craig Nunn

ASSISTANT ART DIRECTOR

Mary Scrimgeour Jenkins

CONTRIBUTING EDITORS

Small Arms

Lt. Col. Jeff Cooper Ken Hackathorn Chuck Taylor

Martial Arts

Rafael Lima

Military Affairs

Capt. John Early

Alexander McColl Maj. Lewis H. "Mike" Williams

Handguns/Handgun Hunting

Lee E. Jurras

Paramedic Operations

Dr. John Peters

Knives/Police Weaponry

David Steele

Terrorism/Latin America

Jay Mallin

Africa

Al J. Venter

West Coast, U.S.A.

Marv Wolf

Survival

N. E. MacDougald

Airborne

Capt. John Early

Aviation

Walt Darran Rocky Kemp Dana Drenkowski

Special Weapons & Tactics

Robert Allman Ludwig Nicholas Ladas II

Explosives/Demolition

John Donovan

BUSINESS MANAGER

Eugene L. Barron

ADVERTISING MANAGER

J. Schultz

ADMINISTRATIVE ASSISTANT

D. Powles

PHOTOGRAPHER

Daryl Tucker

TYPOGRAPHER

T. Edwin V.

PUBLIC RELATIONS

S. Nielsen

SUBSCRIPTION FULFILLMENT

DATA FILES INC.

100 S. Uhle Street

Arlington, VA 22204

(703) 892-0908

SUBSCRIPTION PROBLEMS

CALL

(703) 892-0908 or (703) 892-0900

SOLDIER OF FORTUNE (ISSN 0145-6784/USPS 120-510) is published monthly by Omega Group Limited, 5735 Arapahoe Avenue, Boulder, CO 80303. (303) 449-3750. Second Class Postage is paid at Boulder, CO 80302 and additional mailing offices. \$12.00 for Six-Issue Subscription/\$20.00 for Twelve-Issue Subscription. For Six-Issue Subscription add \$7.00 — Domestic First Class; \$3.00 — Air Canada & Mexico; \$12.00 — Air Europe & Latin America; \$15.00 — Air All Other Continents. For Twelve-Issue Subscription add \$14.00 — Domestic First Class; \$6.00 — Air Canada & Mexico; \$24.00 — Air Europe & Latin America; \$30.00 — Air All Other Continents. Single Issue Price — \$2.25.

CONTRIBUTORS: Manuscripts, photographs, drawings are submitted at the contributor's own risk. Material should be mailed to **SOLDIER OF FORTUNE**, P.O. BOX 693, Boulder, CO 80306, and cannot be returned unless accompanied by sufficient postage. Any material accepted is subject to such revision as is necessary to meet the editorial requirements of SOF. All manuscripts must be typed double-spaced. All photographs should be accompanied by captions. Payment will be made at rates current at time of publication.

CHANGE OF ADDRESS/SUBSCRIPTION PROBLEMS: Six weeks notice is required on all changes of address. Send old address as well as new to: Gene Bedner, DATA FILES INC., 100 So. Uhle St., Arlington, VA 22204.

Copyright (C) 1979 by Omega Group Limited
All Rights Reserved



SOLDIER OF FORTUNE



COVER:

This resolute young Zimbabwe-Rhodesian is well-equipped and well-trained to fight terrorists. He is armed with a FN MAG 7.62mm. The flash identifies him as being a member of the Rhodesian African Rifles, 1st Battalion.

DEFEAT WITHOUT DESTRUCTION 22

How to lose without really trying. You may change your mind on SALT II when you read what Ivan really intends.

DUMBO DROP 30

Jim Morris

The sky is falling, the sky is falling...no, it's just raining pachyderms.

BOMBER BONEYARD 34

Bob Poos

Historic leftovers from the wild-blue yonder find a new home.

ACHTUNG: TERRORISTS

West Germany's elite anti-terrorist unit, GSG 9, can run and hide, and can they fight!

GSG 9: THE UNIT 36

S. Nielsen

GSG 9: THE GUNS 39

Chuck Taylor

GSG 9: THE PHILOSOPHY 43

Jeff Cooper

BUT WILL THEY FIGHT? 46

Marv Wolf

Has the volunteer Army turned it into Benning's School for Boys?



Page 36



Page 46



Page 54

IN MEMORIAM 52

N.E. MacDougald

A tribute to John Berke, master jumper and friend of SOF.

TARGET: GAZA 54

Al J. Venter

An exclusive report on the most massive raid into Mozambique by Zimbabwe-Rhodesian forces.

CASHING IN ON AMERICAN UNITY 87

Brigham Schreiber

Ready and willing to free American hostages? Watch out for recruiting hoax.

Flak	7
Combat Pistolcraft	10
It Happened to Me	12
I Was There	12
Bulletin Board	13
Adventure Quartermaster	18
Editorial	53
Classifieds	91
Advertiser's Index	94



MARCH/1980
VOL. 5, NO. 3

BUY DIRECT AND SAVE MONEY



NEW PARATROOPER FOLDING STOCKS

for the M-1 Carbine and the Ruger 10/22! Walnut with blued ordnance steel, ready to install. Fits all G.I. and commercial Carbines. (Specify mfg.) \$49.95 plus \$2.00 shipping (Specify M-1 Carbine or Ruger 10/22.)

BRAND NEW M-1 CARBINE ACCESSORIES

- 5-shot Magazine \$2.50
- 15-shot Magazine \$2.50
- 30-shot Magazine \$3.50
- 60-rd. Jungle Clip(Clips) \$3.95
- 2-30.rd. mags. together) \$3.95
- Sling & Other \$2.95
- Mag. Pouch - holds 2 or 4 30 rd. mags \$4.95
- Mag. Pouch - holds 2 15 rd. mags. or 4 5 rd. mags \$1.50
- Flash Hider \$10.95
- Muzzle Brake \$10.95
- Ventilated Steel Handguard \$ 3.95
- Piston Nut Wrench - (Double Ended) \$ 2.95 (add 75¢ per item for shipping.)
- Scope Base, no drilling or tapping \$10.95
- Carbines, Cat. 30 Technical Manual \$ 5.95

BRAND NEW RUGER MINI-14 ACCESSORIES

- 20-shot Magazine \$ 8.95
- 30-shot Magazine \$ 9.95
- Ventilated Steel Handguard, Blue \$ 9.95
- Web Sling \$ 2.95
- NEW MINI 14 SIDE FOLDING STOCK Walnut W/blued ordnance steel. Fits series 180 only \$99.95 \$3.00 ship Web Sling \$ 2.95



NEW S.W.A.T. COMBAT MAGAZINE EXTENSIONS FOR YOUR SHOTGUN

Increases shell capacity to 7 (18" or longer bbls.), 8 (20" or longer barrels), or 10 (26" or longer bbls.) Made for Remington 870, 1100; Winchester 1200, SX-1; Browning 5-A; and Marlin 120. Installs easily without alteration. Full Warranty. Now used by the F.B.I., Secret Service and others. Include make, model & gauge when ordering.

- 7 or 8 shot model \$20.00
- 10-shot model (Not available for Browning 5-A) \$36.00 (Add \$2.00 per unit for shipping.)

SCOPE MOUNTS, FLASH HIDERS AND OTHER GUN GOODIES

1. ART AR-15/M-16 Scope Mount, developed for U.S. Army sniper program \$19.95
2. S.W.A.T. Combat Night Firing Device for AR-15/M-16 and AR-18/AR-180 \$16.00*
3. S.W.A.T. Combat Night Firing Device for SIG-AMT, H&K 91 & 93, FN-49 \$16.00*
4. S.W.A.T. Combat Night Firing Device for M1 Garand Rifle \$32.00*
5. S.W.A.T. Rifle Sling for Assault Rifles & Riot Guns, Black 1" Nylon \$ 4.00
6. Mini-14 Flash Hider \$16.95
7. M-16/AR-15 Ordnance & Armorer's Wrench \$12.00

*Also available in fluted M-14 style - same price. Scopes and Mounts install instantly and easily. Add \$1.00 per unit for shipping.

NEW MILITARY SURPLUS BARGAINS!

- All items are Brand New—Direct from the U.S. Government Contractors. The most rugged, dependable, Combat-Proven items available. Do not confuse these genuine items with cheap, inferior imports offered elsewhere!
1. USMC Camouflage Fatigue Suits, 100% Cotton, Latest Issue, Sizes: Small and Medium only. Jacket and pants, set \$39.95
 2. Latest Issue USMC Camouflage Nylon Poncho \$24.95
 3. G.I. Camouflage Poncho \$24.95
 4. NEW! Genuine G.I. Lenticular Compass with nylon carrying case. The latest issue \$29.95
 5. G.I. O.D. T Shirts, 100% cotton, S,M,L,XL. Six of same size for \$18.00
 6. Latest Issue U.S.A.F. MA-1 Flyer's Jacket, Fully reversible, sage green and International Orange. Sizes: S,M,L,XL \$39.95
 7. Latest Issue N2B Short Parka with hood — the ultimate cold weather jacket. Sizes: Small, Medium, Large - \$69.95 — XLarge - \$74.95
 8. Brand New arrival U.S. Navy A-2 Cold Weather Deck Jacket Size: S,M,L,XL \$39.95
 9. U.S. Army .45 Auto Belt Holster, black \$19.95
 10. U.S. Army M-7 Shoulder Holster, fits .45 auto and other large frame autos, black leather \$19.95

11. M1949 Mountain Sleeping Bag, latest issue, mummy style, over 6 1/2 feet long \$49.95
12. G.I. 1st Aid Kit, all emergency items in G.I. OD case that fits on belt \$5.95
13. G.I. Flashlight with extra filters and bulb, O.D. \$4.95
14. U.S. Army O.D. Plastic Canteen with latest issue canteen cover \$5.95
15. Military Police Peerless Handcuffs \$19.95
16. New M-17 Gas Mask with filters & bag \$39.95
17. G.I. Vietnam Combat Pack, used \$4.95
18. Late Issue U.S. Government C-Rations, 12 mixed meals \$34.95
19. Browning 9MM High Power Pistol Holster Canadian Army Issue \$9.95
20. Genuine British Commando Knife, with black leather sheath \$19.95
21. U.S.A.F. Survival Knife with leather sheath and sharpening stone, 5" blade \$11.95
22. U.S. Marine Corps Combat Knife, 7" blade with leather sheath \$12.95
23. U.S. Army Stainless Steel Pocket Knife, 4-blades, 1000 usas \$6.95
24. U.S. Army Machets, 18" blade with O.D. canvas sheath \$9.95

*All items are new, genuine, not import junk! Please add \$1.00 shipping for 1st item, for additional items add 75¢.



COLT .45 AUTO MAGS. & CLIP POUCH SET

G.I. Canvas pouch with 2 Brand New G.I. .45 auto magazines Only \$9.95 (Add 75¢ per set for shipping.)

NEW AR-15 & M-16 30 RD. MAGS & NYLON POUCH

New G.I. Nylon pouch with 3 30 rd. magazines. Only \$21.95 (add \$1.00 per set for shipping.)

NEW RUGER MINI-14 30 RD. MAGS. & NYLON POUCH

New G.I. Nylon Pouch with 3 30-rd magazines \$29.95 (add \$1.00 per set for shipping)

M-1 CARBINE 15-RD. MAGS & POUCH

New G.I. pouch with 2 15-rd. magazines \$5.00 (add \$1.00 per set for shipping)

NEW 8-SHOT TEAR GAS REVOLVER

Fires 8-22. cal. tear gas cartridges or blanks in seconds, Heavy-duty metal construction w/one-step ejection. Checkered grips. BLUE - \$14.95 Sale Priced at only \$8.95 CHROME - \$15.95 Sale Priced at only \$9.95 Hip Holster \$2.00 Tear Gas Cartridges - (10 per pack) \$2.00 Extra-Loud Blanks - (100 per pack) \$3.00 (Add \$1.50 for shipping.)

THE BLACK BOOK OF DIRTY TRICKS

"Improvised Munitions Handbook", is the most sought-after, here-to-fore impossible to obtain Army manual. Includes revealing chapters on: Improvised Explosives and Propellants; Mines & Grenades; Small Arms Weapons & Ammo; Mortars & Rockets; Incendiary Devices; Fuses, Ignition & Delay Mechanisms. Plus how to manufacture Rocket Launchers, Pistols, Shotguns, and recoilless Rifles from easy to obtain materials and much, much more! New expanded edition! Limited Number Available! ORDER NOW! ONLY \$10.00 postpaid

BRAND NEW FACTORY FRESH COMBAT & TARGET MAGAZINES

1. German Luger 9mm \$12.95
2. AR-15/M-16 20-shot G.I. issue \$ 4.00
3. AR-15/M-16 30-shot G.I. issue \$ 5.95
4. AR-15/M-16/AR-180 40-shot, steel \$24.95
5. Ruger Mini-14 30-shot, 223 \$ 9.95
6. Colt .45 Auto, all models, 7-shot \$ 5.00
7. Colt .45 Auto, all models, 15-shot \$15.00
8. Colt .45 Auto, 7-shot stainless \$12.50
9. Colt .38 Super auto, all models \$ 7.50
10. Browning 9 mm Hi-Power, 13-shot \$15.00
- Special 2 for \$25.00
11. Browning 9 mm Hi-Power, 22-shot \$20.00
12. S&W Model 39 9mm auto \$ 7.00
13. Walther P-38 9mm \$12.00

(Add 75¢ per magazine for shipping) SATISFACTION GUARANTEED OR YOUR MONEY BACK!

GENUINE GOVT. SURPLUS U.S.A.F. SUNGLASSES

12 karat gold-plated frames. Optically perfect glass lenses. Impact Resistant Smoke color lenses. G.I. Case included. The real thing! Sale \$19.95 (add \$1.05 for shipping)

SPECIAL SALE! BRAND NEW ORIGINAL G.I. M-65 FIELD JACKETS



These are the latest G.I. issue Nylon/Cotton Construction with exclusive Government quarpel water repellent. Complete with hide-away zipper hood. Sizes: Small, Medium, Large, X-Large, regular length only. O.D. Green or Leaf Pattern Camouflage. Sale! Priced at \$39.95 (add \$2.00 per jacket for shipping.) ORIGINAL G.I. M-65 COLD WEATHER FIELD JACKET LINERS. Sizes, S,M,L,XL \$16.95 ppd.



W.W.I. KNUCKLE KNIFE .19.95 each

Exact reproduction — brass handle, 8" blade. Truly a collector's item. Check local laws before ordering. You must be over 21 years of age to order. *Special 2 for \$35.00 + \$1.50 per knife for shipping.

"PARALYZER" TEAR GAS WEAPON

"Paralyzer" does what the name implies. A heavy spray of tear gas shoots out to a range of up to 18 feet. Causes violent coughing and sneezing and a tremendous burning sensation to the eyes, nose and throat and skin. Completely disables the assailant for 10-15 minutes without causing permanent injury. You must be over 21 years of age to order. No sales to California. Add \$1. shipping

POCKET MODEL . \$4.95 ea. SPECIAL - \$36./dozen POLICE MODEL. \$6.95 ea. SPECIAL - \$48./dozen

BRITISH COMMANDO BATTLE JACKET

This attractive jacket is brand new British government surplus. A lightweight, rugged, all-purpose jacket made of O.D. color, heavy-duty denim. May never be available again. Sizes: S, M, L. Only \$9.95 (plus \$1.50 shipping) *Please send height, chest and waist measurements for an exact fit.

VIETNAM JUNGLE HAT The soft, collapsible hat made famous by our troops in Vietnam. Very comfortable. Sizes: S,M,L, XL. O.D. GREEN — \$4.95 CAMOUFLAGE — \$4.95 (Add 75¢ per hat for shipping.)

"THE LITTLE BLACK BOX"

Warning this device is not to be used for surveillance! Automatically starts recorder when telephone is picked up. Records entire conversation... Then automatically stops recorder when phone is hung up! Can be attached anywhere along the line — plugs into ANY recorder and causes absolutely no interference or noise on the phone. Extremely useful around the home or office for making ACCURATE and PERMANENT records of all incoming and outgoing calls. MINIATURE! Only 1" x 2" x 3"

Special Sale! Now Only \$29.95 plus \$1.00 shipping
Quick-Release Vietnam Issue Pistol Belt. \$5.95 plus 75¢ shipping.

BA, MC, GOD's may call 800-323-3233 — \$25.00 Minimum phone order. Illinois, Alaska, Hawaii call 312-598-4466. PARELLEX CORP. Chicago Ridge, IL To order by mail use, the coupon below or separate sheet. Mail with payment.

Mail to: Parellex Corp. Box F, Chicago Ridge, IL 60415 Dept. S-29

Please send following _____

Money Order Check Enclosed \$ _____

CHARGE TO MY: Mastercharge Visa/Bankamerica Card

Satisfaction Guaranteed or your Money Back! ILLINOIS RESIDENTS INCLUDE SALES TAX

My name is _____

I live at _____

City _____ State _____ Zip _____

Please send new illustrated catalog. \$1.00 enclosed. Catalog free with order.

FLAK

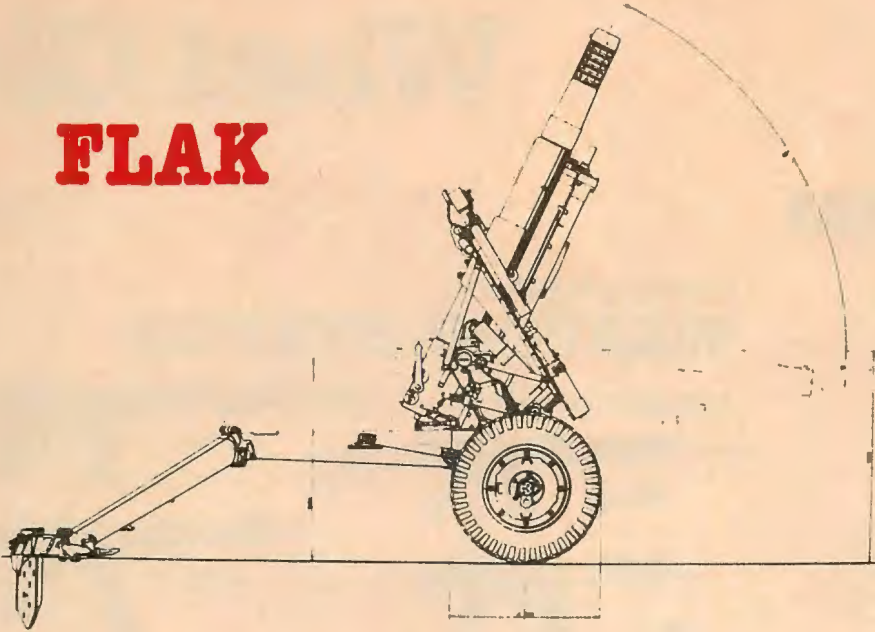

READERS SPEAK OUT ON IRAN ...

Sirs:

Tonight (12 November 1979) on NBC news, I saw a photograph of a U.S. Marine captive in full-dress blues before an American flag, stating in a taped interview, "Carter is handling the situation wrong. He should send the Shah back and secure our release."

In other words, let the Iranians blackmail and humiliate the greatest country in the world. I wonder how much those filthy Iranians beat or tortured that Marine into saying that. Let's finally go in there and do the job we're constantly training for.

Joseph P. Smith
Brunswick, Maine

Sirs:

In regard to the high priest of Iran and his playful little boys, how long must we be forced to sit still and take the trash that is thrown at us? How much apologizing are we going to do for being alive?

I am a civilian who works for the defense establishment (government) and I am becoming increasingly tired of having J.C. Stupor Star and his trained seals apologizing for me when I do not feel that we have done anything to be ostracized for. Yes, we allowed the Shah to enter our country for medical reasons, but the man has lymphoma and the cure rate is not too good on that.

If we had denied the Ayatollah or any of his group the same privilege, we would be called every name in the book. These upstarts feel they have the right to dictate to us whom we can medically treat. Some feel they have the right to desecrate our national monuments and ask us to send the Shah back to Iran but they are unwilling to return themselves.

I love my country. We have our faults but at least we admit them and attempt to correct them. There are very few clear voices in the world's present insanity, but

MARCH/80

I would say you qualify as one of the clearest. Please continue with your outspokenness and willingness to stand up to those fools willing to accept attempted whitewash. Be the clarion voice of sane people in this fight against stupidity and hypocrisy now rampant in the halls of our government.

Sincerely,
F.A. McAuliffe
Gaithersburg, Maryland

We hereby pick up the gauntlet. We promise to continue telling it as we see it.
— The Eds.

Sirs:

I would sincerely like to know what the HELL is happening to our great country! When is America going to put her foot down and stop getting stepped on? I am an active member in the United States Marine Corps and am sick and tired of all the BULLSHIT that is going on here and abroad. Gas prices rising sky high, inflation out of control, and our elders, people who built this country, might have to possibly choose between eating and staying warm this winter, never mind the coming winters.

Overseas, our embassies are being overrun, twice in the same year in Iran. Why are the guards armed? A show of force maybe, because when the time comes to use them, they're usually under orders not to shoot. Our foreign policy is going down the drain. When somebody is breaking into your house, do you try to talk him into leaving, or use force? Like my father told me when I was a kid, "When words fail, force prevails." DAMMIT, no wars were ever won with words.

Sincerely,
Sgt. Thomas R. Hussey
United States Marine Corps
Albany, Georgia

Continued on page 14

LEARN POLICE SCIENCES and LAW ENFORCEMENT

Prepare at home in spare time—No previous training necessary

The LAW ENFORCEMENT COURSE Written by Experts Based on Actual Police Academy Training Programs!

If police work sounds exciting... if crime prevention, helping others, and making the world a better place to live are important to you, send for free information about Police Sciences Institute.

The experts on our staff have trained hundreds of men in resident police academies, and now you can get that same knowledge at home, in your spare time.



Experts Show You What to Do, How to Do it... Guide You Every Step of the Way! Everything explained in easy-to-understand language, complete with drawings, diagrams and photographs. You'll learn everything

from patrol procedures, criminal investigation techniques—fingerprints, photography, gathering evidence—to traffic control, accident investigation, crowd control and making arrests. Every subject based on actual instruction used in recognized police academies.

DO YOU FEEL QUALIFIED FOR ENROLLMENT IN THIS COURSE? You should have a serious interest in law enforcement and must be of good character. Your purpose in taking this course should be one of the following:

1. TO PREPARE FOR RESIDENT POLICE ACADEMY TRAINING. Although entrance requirements ordinarily do not require previous training, this course can make your training easier after you are accepted.

2. TO PREPARE FOR EXAMINATION where knowledge of police practices count, offered by cities, counties and others to screen applicants for police work.

3. TO LEARN POLICE WORK AS A BACKGROUND FOR STUDIES IN OTHER AREAS OF LAW ENFORCEMENT SUCH AS parole officer, park ranger, correctional institution or working in security for business and industry.

4. TO EXPAND YOUR KNOWLEDGE OF POLICE SCIENCES for your own interest. Perhaps you want to do volunteer work or become a reserve police officer, or are interested in police sciences and criminal investigation to improve your education.

Since this course is new, we are not able to tell you about the experience of our students in getting jobs

HERE ARE JUST A FEW OF THE SUBJECTS YOU CAN LEARN

- Criminal Investigation
- Traffic Enforcement
- Evidence Collection
- Latent Fingerprints
- Crime Scene Search
- Auto Theft Investigation
- Patrol Procedures
- Narcotics Investigation
- Crime Lab Functions
- Criminal Law
- Hit and Run Investigation
- Use and Care of Firearms
- Law of Arrest

COURSE INCLUDES 3 BIG KITS

Learn How to Photograph Crime Scene

You receive camera, film, flash bulbs, batteries and Course Supplement—"Crime Scene Photography."

Fingerprinting Field Kit

Includes powder, brushes, fingerprint strips, sensitizing pad to lift latent fingerprints... plus Course Supplement—"Fingerprints"

Evidence Collection Kit includes sampling pipette, collection bottles and bags, slides and training microscope... plus "How to Use a Microscope in Police Work."

Plus much, much more including Traffic Investigation Field Kit, Drug Enforcement Fact Book, Physical Conditioning and Illustrated Policeman's Glossary.

CALL TOLL-FREE 1-800-228-2028/EXT. 375

(Except in Nebraska call (402) 571-4900/Ext. 375, Dept. RS030 CALL ANYTIME—Operators to take your call 24 hours a day, 7 days a week. No cost. No obligation. No salesman will call.

OR MAIL COUPON TODAY

Police Sciences Institute, Dept. RS030
4401 Birch Street, Newport Beach, CA 92660

Please rush me free facts and color brochure that tell how I can learn Police Sciences and Law Enforcement at home. No obligation, no salesman will call.

NAME _____ AGE _____
ADDRESS _____
CITY _____ STATE _____ ZIP _____

SOLDIER OF FORTUNE 7

What Give

Caliber 7.62mm: NATO WEAPONS SYSTEM

Automatic Rifles



Machine Guns



Sniper Rifle



HANDGUNS

Machine Pistol



Automatic Pistols

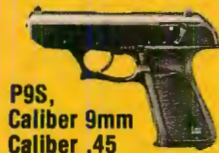

Caliber 5.56mm WEAPONS SYSTEM

Automatic Rifles

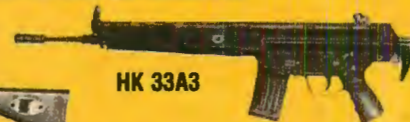

Sniper Rifle



Machine Guns



SUBMACHINE GUNS

Caliber 9mm



Silenced Submachine Guns

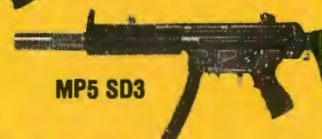

HECKLER & KOCH GMBH

7238 Oberdorf/Neckar, West Germany

Telephone: (07423) 79-1

Telex: 760313

Cable Address: Heklerkoch

Give us the Edge in Weaponry?

Systems Technology!

SPECIAL PURPOSE WEAPONS



G-3 Rifle with
HK 69 attached

Grenade Launchers



HK 69A1,
Caliber 40mm



HK 33 Rifle
with
HK 69 attached

GUN MOUNTS



Tripod Mount "L"
1102 with HK21A1 MG



Column Mount on
Circular Track 2401
with HK21A1 MG

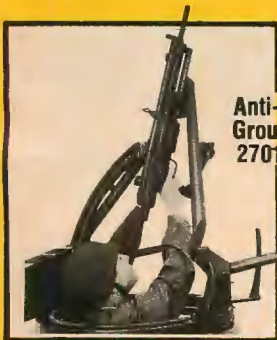

Anti-Aircraft/
Ground Target Mount
2701 with HK21A1 MG

Weapons Accessories

A full line of system engineered combat and general accessories, sighting devices, and training aids is available now for all H&K weapons.

TOMORROW'S WEAPONS SYSTEMS!

Heckler & Koch, GMBH, developer and manufacturer of West Germany's G3 Rifle, is one of Europe's leading small arms R&D and production firms. H&K has developed and produced systems engineered families of military small arms weapons systems, accessories, and gun mounts. Each family is product-engineered to insure a 49% commonality of parts and modular sub-assemblies and a 90% commonality of accessories and attachments.

Heckler & Koch's advanced systems technology and low-cost production techniques will give your combat forces the edge on the battlefield. H&K produces systems engineered weapons families in either 7.62mm NATO, 5.56mm or 9mm calibers; plus complete lines of matched accessories and training aids.

No matter what your choice of caliber H&K weapons families provide:

- *Versatile Tactical Employment*
Choice of caliber and weapon according to tactical situation.
- *Reliability, Simplicity and Ruggedness*
Over 7 million weapons employed world-wide.
- *Simplified Training and Handling*
Once trained, one shooter can handle all weapons.
- *Simplified Maintenance*
75% maintenance at operator/organizational level due to maximum interchangeability of modular components, parts, and accessories. Remaining 25% at direct support level. None at general support level.
- *Effortless Supply & Storage*
Due to commonality of modules, parts, and accessories.
- *Low Cost Production*
Large-scale utilization of stampings and cold-forming technology.

H&K

% HECKLER & KOCH, INC.
SUITE 218, 933 NORTH KENMORE STREET
ARLINGTON, VIRGINIA 22201
(or call (703) 525-3182)

For more information on Heckler & Koch military weapons systems, simply fill in this coupon and mail to:

Name _____
Unit _____
or Company _____

Address _____

City _____

State _____ Zip • _____



LEARN

The New Pistolcraft

At Jeff Cooper's
API Training Center.

The American Pistol Institute is now accepting applications for training of police, military and civilian students (with proper credentials) at the new 170-acre training center. Basic course teaches you to shoot carefully and quickly; to hit single, multiple and moving targets; to move correctly; to maintain continuity of action; to respond properly to the unexpected; and much more. Unique, proven teaching method quickly imparts the decisive skills of modern defensive pistolcraft.

FOR 8-PAGE BROCHURE, SEND \$1 to:

The American Pistol Institute
Box 401-x Paulden, AZ 86334

HECKLER & KOCH ACCESSORIES

MAGAZINES

Cat. No.	Price
120 - HK91 20 Rd	\$ 17.50
125 - HK93 25 Rd	17.50
140 - HK93 40 Rd	22.00
110 - HK770 10 Rd	17.50
115 - HK300 15 Rd	17.50

COMMON ACCESSORIES

250 - HK91/93 Light Bipod	90.50
221 - HK91 Cleaning Kit	13.75
223 - HK93 Cleaning Kit	13.75
230 - Web Assault Sling	17.00
290 - Sight Adjusting Tool	15.75
235 - HK91 Carrying Handle	17.00
200 - Ejection Port Buffer	20.00
272 - 1" Ring Inserts for 30mm Scope Mount	16.00
001 - HK91 Web Pouch Holds two HK91 20 Rd Mags.	2.50 ea.

Not made by H & K - Used

H & K EMERGENCY FLARE KIT

010 - W/5 Rd Mag. Cal. 19 mm	120.00
000 - Star Flare	2.50 ea.
10 or more	2.25 ea.

H & K SHOULDER PATCH

Included Free with \$300.00 order
or order Cat. No. 915

All items are in stock, however quantities on some items are limited! Orders filled on first come first serve basis. Send: Money Order, Bank Check or Visa & M.C. on orders over \$100.00 include Name, Address, Zip-Acct. No & Exp. Date.

H & H FIREARMS
P.O. BOX 12 • PENNDEL, PA 19047

COMBAT PISTOLCRAFT



Jeff Cooper & Ken Hackathorn

SOF's Combat Pistolcraft column welcomes letters from our readers. If you have a question or contribution, send it to Jeff Cooper, c/o SOF, P.O. Box 693, Boulder, CO 80306. For a quick, personal reply, include a self-addressed, stamped envelope.

Q I would like any information you might have about the new Mossberg AIG military .45. Is it a good gun for the money? Does it print well? Have you shot it yet? I would like to buy a small .45 to carry. I'm not concerned about weight, just size. None of the small ones seem like they're worth a damn.

W.E.Y.

Lancaster, Pennsylvania

A I have seen the Mossberg .45 but I have not been sent one for evaluation. I am always a little nervous about weapons that are not available for study. From a superficial standpoint its design appears flawed. Its double-action is not selective and the safety is badly designed. In all fairness, however, I must reserve full judgment until I have evaluated the piece at leisure.

Q SOF has mentioned the Czech Model 1975 pistol in 9mm Luger. Have you handled and used this pistol? What is your impression of it? SOF seems to praise it and I myself — with limited exposure to this pistol — am greatly impressed. Could you tell me if it is imported into the U.S. and if so where I can buy one?

J.E.K.

Granada Hills, California

A The Czech 75 pistol is the best design of its type. It may not be legally imported into the United States. You may read my review of this weapon in *Guns Magazine* and *Chuck Taylor's in the October '79 issue of SOF*.

Q I am considering purchase of my first handgun. Its primary function will be informal target shooting as opposed to personal defense. The indoor section of our range requires standard loads with wadcutter or semiwadcutter bullets — anything goes on the outside range, how-

ever.

The three calibers I have chosen to limit myself to are .38/.357, 9mm and .45 auto. Which caliber do you suggest and in what handgun? If possible, I would like something reasonably accurate, versatile, economical and reliable, as good gunsmiths are nonexistent in this city. As a handgun is quite an investment here due to the price (Colt Commander, \$425; Hi-Power, \$375; S&W No. 19 .357, \$275), I wouldn't like to make a mistake.

A.C.

Montreal, Quebec, Canada



Alessi Fieldmaster holster's pivot feature puts large-frame DA revolver at more efficient angle for combat work. Unlined holster costs \$57, lined \$65.

A It is my belief that you can obtain the Czech 75 pistol in Canada. If this is true, it would be my first choice for you in 9mm. Since your purpose is informal target shooting and not personal defense there is not a thing wrong with the 9mm cartridge.

Q I have API's impressive brochure and am looking forward to attending someday. Have been trying to decide what to use: my six-inch Python, four-inch Combat Magnum, Hi-Power, or (sound of trumpets) one of my M1911A1s. Before using one of the latter, it would have to be accurized. Enjoyed your "30 Instant Shooting Answers" (SOF, *Combat Pistolcraft*, Nov. '78) and

after reading through all the stuff I have about accurizing the .45, found answers to most of my questions. I visited Behlert's on a recent trip east and was inspired to try gunsmithing myself. I'm a pretty good machinist — have access to most tools (Bridgeport miller, lathe, Heliarc welder, etc.) so should be able to handle it.

Are there any advantages to high sights for the .45 — other than ease of installation in the original dovetail? I'm having difficulty deciding on an adjustable rear sight: Behlert? BoMar? Micro? MMC? S&W? K&N? Any suggestions? (I wish they'd make sights with dime-size adjusting screws instead of those damned razor-blade-thin slots.)

I just funneled the magazine wells on my .45s. Nothing to it! I realize now that I was kind of in awe of them, but they're just metal — like other metal I've worked.

Could you tell me what alloys are used in steel and aluminum frame M1911s? Or at least which alloys are most commonly used in handguns? Heliarc welding is tricky enough even when you know the alloy. I'm tempted to try making one of those hooked-type trigger guards.

Your literature stated, "Holster (trigger guard covered)." Is that an absolute must? I have a Jackass with exposed trigger guard and am considering getting more. Would it be okay?

E.H.

Walhalla, North Dakota

A If you do decide to enroll at Gun-site, I suggest you bring one of your 1911s. Students get best results from a properly designed auto pistol.

I don't know quite what you mean by "accurized," but unless there is something wrong with your 1911s there will be no need for an accuracy job in the course of our instruction.

"High visibility" sights are almost a necessity with the Colt Commander model since those furnished are too small to be picked up quickly. I do not suggest that you put one of those extravagant "sailfish" arrangements on top of your piece but simply get the sight up to where you can see it. This is a matter of about 3/16ths inch. I have been using a recessed BoMar rear sight with good results so far, but others work too.

I fear I'm not competent to discuss metallurgy with you. Even if I did have the alloys used in present manufacture there is no assurance that they will stay the same between runs.

I feel you can save yourself a lot of trouble by avoiding a hooked trigger guard. This is a useless embellishment. If you need additional purchase in front of the trigger, simply stipple or checker the front of the trigger guard.

A covered trigger guard is extremely important, but people do survive without it.

Continued on page 79

Meet the Master of GUN CONCEALMENT



John Bianchi, holster maker supreme and former police officer, has designed and made more holsters than perhaps any man in history. The reason is simple: countless thousands of satisfied repeat customers around the world, spanning the last quarter of a century. Customers whose needs for quality, dependability, and unique design caused them to select BIANCHI time after time. Uniformed patrol officers, detectives, narcotic agents, the U.S. Border Patrol, and countless foreign and U.S. Government law enforcement agencies have depended on BIANCHI to deliver the very best gunleather available. When quality and performance come before price, BIANCHI is the Number One choice, with over 100 holsters, belts and accessories to choose from. This includes uniform holsters, shoulder holsters, concealment holsters, and field holsters. BIANCHI GUNLEATHER, the world standard by which all gunleather is judged. If you have the need, BIANCHI has the answer. BIANCHI GUNLEATHER for the serious shooter. At Authorized Dealers worldwide. Complete full-color catalog \$1.00.

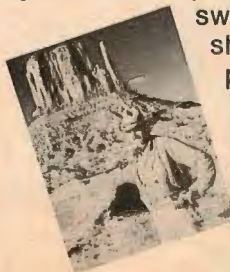

BIANCHI
GUNLEATHER™

100 Calle Cortez, Dept. SF3-80, Tempecula, California 92390

I WAS THERE

by R.M. Bailey

R.M. Bailey of South Charleston, W.Va., is a dog fancier, whose favorite breed is the Rottweiler, not, as he says, to be confused with "those inbred, noisy idiots some call Dobermans." He's also a jogger who can still manage a five-minute mile. As he tells it:

AT approximately 11:45 p.m. one hot August evening, I started to jog along my usual route. After a mile, I reached the house where my best friend lives with his family. Suddenly, I spotted a dark shadow moving along the side of the house toward the front porch.

I kept jogging so as not to frighten him. Beyond the gate I crouched on all fours beside a parked car, then, crab-like, sidestepped around it until I was positioned behind a hedgerow at the corner of the lot where I could wait in ambush.

The hedgerow conceals an old, rusty, barbed-wire fence and is bounded by a small ditch. Beyond it stands a seven-foot fence — not to keep people out but to keep the family's security-trained pair of Rottweilers inside the dog run. Beyond the dog run is a small creek.

Soon the hedgerow rustled. I saw a dark figure leap the porch rail and skulk toward the front door. When I pounced from behind the hedge, he bounded off the porch like a clumsy young giraffe.

Suddenly, I slipped on a muddy patch at the edge of the ditch and fell headlong into it. The intruder ran for the hedge. He hit it — once — twice — three times before getting through. He leaped over the seven-foot fence — but he didn't make it to the creek. When we managed to pull the dogs off him, he barely made it to the hospital.



IF you have a combat or adventure story for "It Happened to Me" or "I Was There," triple-space type it and send it to SOF, P.O. Box 693, Boulder, CO 80306, Att: M.L. Jones. All stories should be 500 words or less. Upon publication, SOF will become owner of all publication rights. Submitted articles are subject to editing and revision, although their content and theme will not be changed. Photos are also helpful. Enclose a stamped, self-addressed envelope so we can notify you of acceptance or return of your story. Article payment is \$50, upon publication. All entrants will receive an SOF patch.

IT HAPPENED TO ME

by Steve Newman

In 1968 during the dry season in Vietnam's central highlands, Lt. Steve Newman assumed command of the recon platoon, 1st Battalion, 8th Infantry of the Fourth Division, U.S. Army. When he received a call to assist a mortar platoon at a CIDG outpost that was drawing heavy fire, he and his men went off to Vung Dat Am (Hill 451) near Duc Co, arriving with just enough time to get dug in before dark. Newman, who was briefed by Spec. 4 Robert D. Jella, in command of the mortar unit, tells it this way:

JUST after dark the fun started. We saw movement just outside the perimeter. I set off a hand flare. Within seconds we were drawing small-arms fire and incoming mortar rounds. In the quiet just after a mortar round exploded, I heard a strange swishing noise, followed by a thump in the parapet of the bunker close to my head. I figured it must have been a piece of shrapnel.

A short while later during another lull in the firing, as I scanned the perimeter with a Starlite 'scope, the noise was repeated. I looked to my left and saw two crossbow shafts half buried in the bunker a foot from my head. Then Spec. Jella saw four more in the sand about two feet in front of the bunker. We had two possibilities: either someone had infiltrated the perimeter or one of the CIDG forces was a VC. Either way, we couldn't spot the character with the crossbow.

Just then the fog rolled in. Visibility dropped to a few feet. A short while later, a mortar round went off just outside the perimeter while I was again looking through the Starlite. The flash beautifully silhouetted my crossbow-carrying VC in front of my position, about 50 feet out. We hadn't spotted him because he was completely hidden inside a burned-out tree stump just outside the wire. We figured he must have crawled in just after dark before the shooting started. The stump stood in a low spot out of our line of fire. A grenade made short work of our arrow-firing friend.

After the action ground to a halt, I radioed a situation report to my battalion commander, who was dumbfounded, to say the least.

Next morning, I found a huge sign made of C-Ration cases over the front gate, reading, "Welcome to Fort Apache." My troops began calling me General Custer and requesting a Gatling gun and cavalry mounts for our next resupply. During breakfast, an unannounced chopper dropped and disgorged reporters from *Stars & Stripes* and UPI as well as several of the brass. The reporters interviewed the troops and the brass collected the arrows for souvenirs to commemorate Hill 451, better known as Fort Apache — Vietnam style.

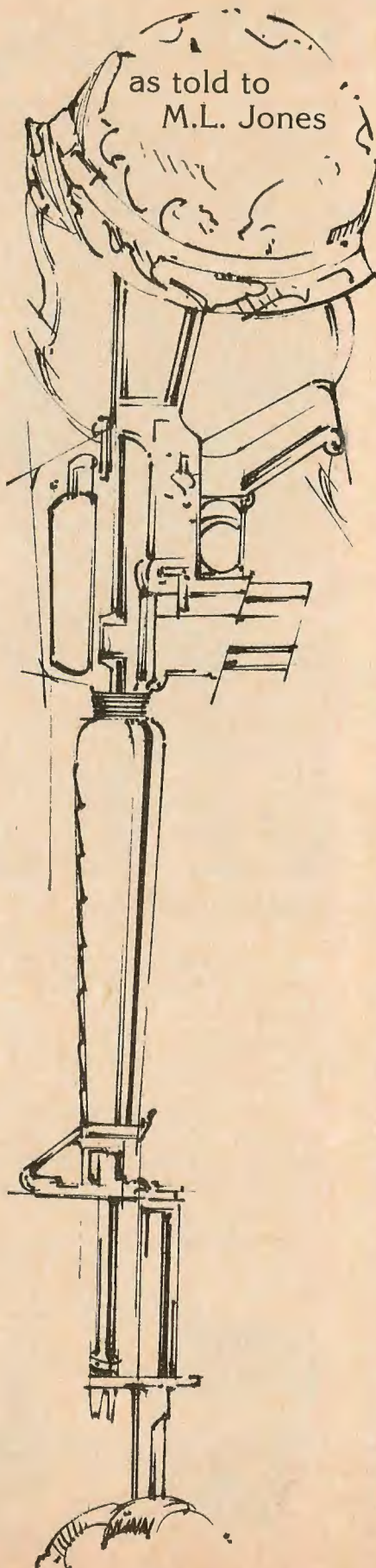

BULLETIN BOARD



NEW STAFF MEMBER ...

Jim Graves, a former Marine, with over 11 years of journalistic experience, has joined the *Soldier Of Fortune* staff as an associate editor.

He served as an infantryman in the Third Marine Division from January 1967 to February 1968 at Khe Sanh, The Rockpile, Con Thien, Dong Ha, C-2 and other points along Vietnam's DMZ.

From March 1968 to June 1969, Graves was assigned to the Joint Informational Services Office in Camp Lejeune, N.C. as a combat correspondent. He covered assignments on the East Coast, in the Caribbean and Latin America.

From June 1969 to November 1979, he served as sports editor of the Jonesboro *Sun* in Jonesboro, Arkansas.

He has a bachelor's degree in history and a master's degree in United States history.

WE DIDN'T DO IT ...

All SOF contributors, advertisers or subscribers should be on the lookout for mail containing material you would not expect from us.

Some as yet unknown individual, or individuals, has started sending letters containing spurious material with the SOF office listed in the return address area.

If you should receive any material that is suspicious, send the material and the envelope to us so we can turn it over to the proper authorities.

RHODESIANS TAKE RUSSIAN TANKS ...

Ian McClure, a SOF source in Rhodesia, reports that Rhodesian security forces captured Russian T-54s and T-55s in recent raids into Mozambique.

Security forces startled Rhodesian motorists on Salisbury's Enterprise road by bringing in two of the captured tanks on November 17. A spokesman for Combined Operations declined comment on the origin of the equipment. McClure also reported that six Russian tanks unsuccessfully tried to intervene in an attack on ZANU terrorist bases in September.

On November 20 Zambia's president, Kenneth Kaunda, cancelled all military leave and announced a call up of reserves as Zambia mobilized its entire army.

In a press conference Kaunda announced: "We are now in a full-scale war situation." He appealed to friendly countries (Angola, Mozambique, etc.) to provide Zambia and the patriotic front with aid to "fight this just war to its logical conclusion."

Kaunda's action will bring an additional 15,000 to 20,000 reserves into the talent pool for Zambia's 20,000-man army, an army that so far has not been able to prevent Rhodesian air- and helicopter-borne attacks against terrorist camps in Zambia.

DON WE NOW OUR ...

San Francisco (where else) inducted its first group of admitted homosexuals into its police department in November.

Mayor Dianne Feinstein swore in the class of 50, which also included nine women and 16 minority members. The number of homosexuals was not disclosed but Les Morgan, director of the Gay Outreach Program that was set up to smooth the way for employment of homosexuals, said that among the 200 police candidates scheduled to start training in the next eight months were 16 admitted homosexuals, including seven lesbians.

"The reason they are going into the department is because they want to be good police officers, not to make points for the gay movement," Morgan said.

WOMEN AND WAR ...

The Carter administration is urging Congress to drop its ban against women in combat.

Robert B. Pirie, assistant secretary of defense for manpower, and retired Maj. Gen. Jeanne M. Holm spoke in favor of lifting the ban before the House Military Personnel Subcommittee chaired by Rep. Richard C. White, D-Texas.

Continued on page 21

DEPENDABLE

Finest
Pistol &
Rifle

MAGAZINES

STEEL FABRICATED

Mfg. in U.S.A. by D & E MAGAZINES



FOREIGN ORDERS Be sure to use U.S. currency and send enough to cover for air freight charges.

CALIBER	DESCRIPTION	PRICE
22	Astra Constable Llama	9.95
22	Browning Balguin made	11.95
22	Browning U.S. made	12.95
22	Beretta 70's Inchangeable 70,101,76	11.95
22	Colt New or Old mod. spe	11.95
22	Cold ACC New or old	18.95
22	Colt Conversion Fps 9mm, 38, 45, Gov. Mod.	24.95
22	Hi-Standar Sport King, Sharpshooter, B.HB,GB	11.95
22	Hi-Standar, Victor, Citation, Supermatic, Trophy	11.95
22	Hi-Standar HB, "B", "GB"	13.95
22	Hi-Standar H.D, H.A, D, A, HE, GE, GD	11.95
22	Llama Fit, new mods. (14 Rds. 13.95) Reg. size	11.95
22	Llama older mod. "Foreign made"	9.95
22	Mab mod. G.L.R. (Sterling mod. 302 8.95)	9.95
22	Ruger new or old, specify model	9.95
22	Smith & Wesson mod. 41 (22 Stw mod 61 8.95)	11.95
22	Star FN, FR, FRS, Walter PPTPPK/S	11.95
25	Armi-Galest mod. 9, 8.95, Galest late mod.	9.95
25	Bauer, Browning, Buffalo, Bernardelli	8.95
25	Beretta deteire mod. 950, Beretta, mfg. 1941	8.95
25	CZ. Best Pocket, Draft, Guardian,	9.95
25	Mab. 6.35 mod. A., Mars 6.35, Protector	8.95
25	Raven, F.I.E. mod. A27, Wilkinson	8.95
25	R.G. mod. 25, R.G. mod. 42, Targa	8.95
25	Titan E 27B, Sterling 300	8.95
25	Unique Mikros Colt Pre-war	8.95
25	Colt Jr. late mod. (15 Rds. 12.95) Reg. size	9.95
32	Astra Constable, Astra pre-war 1916	8.95
32	Beretta made 1934 to 38, Beretta mod. 100	9.95
32	Browning pre-war 7 or 8 rounds, Specify	10.95
32	Colt, Ceska, Bernardelli, Remington	9.95
32	Mausey HSc, Mausey A G 7 rds.	10.95
32	Llama fits all new modes	10.95
32	Savage Rds. 18.95 Reg. size	11.95
32	Ortiges, Star old military 7.65	9.95
32	Walthe 7.65 PPK (15 rds. 16.50) Reg. size	10.95
32	Walther PPK/S (15 Rds. 16.50) Reg. size	10.95
32	Unique 7.65 court 9 coups, "HK 4"	10.95
380	Astra Constable (15 Rds. 16.50) Reg. size	9.95
380	Beretta 1934 to 1938	9.95
380	Beretta 70's (15 rounds 16.50) Reg. size	10.95
380	Other Berettas soon in production	Soon
380	Brownin mfg. 1971, Bernardelli any mod.	10.95
380	Back-up 9mm Kurz (Astra 3000 10.95)	8.95
380	Llama fit all new (Mod. 15 Rds., 16.50) Reg. size	9.95
380	Mab. mod. D, Mausey HSc, Ortiges, Remington	10.95
380	Star FI Fist mod. (15 Rds. 16.50) Reg. size	9.95
380	Star FI Snd. Mod. (15 Rds. 16.00) Reg. size	9.95
380	Savage Rds. 18.95 (turky MKE 10.90) Reg. size	14.95
380	Sterling mod. 400 (15 Rds. 16.50) Reg. size	9.95
380	Walther PP & PPK/S (15 Rds. 16.50) Reg. size	10.95
380	Walther PPK (15 Rds. 16.50) Reg. size	10.95
9mm	Astra 400 mfg. 1921, (9mm Colt 12.95)	12.95
9mm	Browning H.P. (25 Rds. 27.50) Reg. size	18.95
9mm	Beretta mod. 951 (14 Rds. 18.55) Reg. size	12.95
9mm	German P-08 (10 Rds. 14.95) Reg. size	13.95
9mm	Labi 17.95, 9mm, Llama fits all new mod.	12.95
9mm	Mab PA-15 (25 Rds. 27.50) Reg. size	18.95
9mm	Smith & Wesson mod. 39 (14 Rds. 17.95) Reg. size	12.95
9mm	Smith & Wesson mod. 59 (25 Rds. 27.50) Reg. size	18.95
9mm	Star mod "A", star mod. B, star B.S.	Reg. size 12.95
9mm	Starlight BKM & MKS (14 Rds. 17.95) Reg. size	12.95
9mm	Walther P-38 & P-38K (14 Rds. 17.95) Reg. size	12.95
9mm	Radom P-35 (14 Rds. 17.95) Reg. size	12.95
9mm	Mausier (10 Rds. 14.95) Reg. size	13.95
30	Tokarev Mauser 7.63 and 7.65	14.95
38	Colt National Match (Mid-Range)	17.95
38	Colt Rimless smokeless 7 or 8 Rounds	12.95
38	Colt Supper fit all (20 Rds. 22.95) Reg. size	12.95
38	Llama fits all new models, Star A.S.	12.95
45	Colts fits all mod. 25 rds. 22.95	Reg. size 12.95
45	20 rds. 18.95, 15 rds. 17.95	Reg. size 12.95
45	Detonics (15 Rds. 18.95) Reg. size	12.95
45	Llama fits all new mod. 25 yds. 22.95) Reg. size	12.95
45	Star mod. P.S. 25 rds. 22.95) Reg. size	12.95
45	Star mod. (P.D. 15 rds. 17.95) Reg. size	12.95

SPORTING RIFLES MAGAZINES

22	AR-7 Explorer (15 rds. 18.95)	8 rds. 8.95
223	Ruger mini-14 (30 rds. 19.95, 20 rds. 14.95) 10 rds.	8.95
30/06	Remington 742 (12 rds. 26.95) 8 rds. 22.95	4 rds. 9.95
30/06	Remington 760 (12 rds. 27.95)	4 rds. 9.95
308	Remington 742, 8 Rounds	24.95
303	British Enfield 10 Rds.	22.95
9mm	Jet-Eire Model M68 25 Rounds	27.50

NO CHARGE FOR MAILING & HANDLING

Please compute your own tax on your order. Orders will fill within 3 days in-plant with money order or certified check; allow 3 weeks with personal checks.

For up-date production price list send \$2.00 to cover our expenses (will ignore requests without cover charge).

D&E MAGAZINES MFG.

P.O. Box 4579 "B"
Downey, California 90241

Price List for 1979



The "Woolly Pulley"!

Long Traditional with British Services
100% Virgin Wool Sweater

British-made with matching rugged twill reinforcing patches. Mens, womens sizes 32 to 48.

Get yours postpaid for only \$49.95.

A great ribbed knit sweater for backpacking, boating, hunting and all cold weather activities. Extra long body prevents "ride-up". Reinforcing patches over shoulders and elbows for nearly "everlasting" wear. Home washable. Choose from **Olive Green, Navy, Blue-Gray, Forest Green and V-Neck, Tan.**

OLIVE GREEN AUTHORIZED BY U.S. MARINES FOR OPTIONAL WEAR



W. GERMAN PARATROOPER BOOTS
"FALLSCHIRMSPRINGERSTIEFEL"

The original German Airborne Issue Boot Prized by those that know. Rugged and comfortable beyond compare. Black Leather uppers that'll take a shine. Patented speed lacing system. Fully lined with cushioned protection for ankle bones. Closed tongue, waterproofed, double stitched, hygenic. Non-slip rubber heel and half-sole. A boot for every jumper or hiker. Sizes 6 to 12, Regular & Wide only. **Now \$99.95.**

Special jump Inserts.

The **ULTIMATE**. Molded to conform to the foot. **Specify Size \$7.95**



TEAKWOOD PARACHUTE WINGS

Beautifully hand carved in Thailand. Framed and ready to be displayed. Last chance to obtain. Closeout. **\$21.50**



CAMOUFLAGE T-SHIRTS

At last, a regulation 'Nam Leaf Pattern Camo T-Shirt. Full Cut, 50/50 blend for comfort. Perfect match with Jungle Fatigues. Sizes S, M, L & XL.

Short Sleeve - \$5.95

Long Sleeve - \$7.95



BERETS, Mil-Spec 100% Virgin Wool, fully lined, leather sweat band. **S.F. Green, Airborne Red, Ranger Black, Khaki.** State Head Size in inches. **\$10.50**

UTILITY CAP, USMC Type 2, new issue, camo pattern, S.M.L., - **\$5.00**

JUNGLE FATIGUES, Camo, Genuine issue, rip-stop poplin. Sizes S, M, L - **\$42.95**



W. GERMAN ARMY UTILITY KNIFE, Victorinox made w/OD scales. 4 tools, **SAK-542, Special - \$11.95**

"DOG TAGS"

Complete G.I. Specification Identification Necklace. 2 stainless steel plates and chains embossed with your information. 16 characters per line/5 lines/tag. Great for medical info or identifying keys & luggage. **Set, only \$5.95**

"NAME TAPES"

Mil-Spec web with embroidered info. Choice of **Black on O.D., White on Blue or Black on White.** For uniforms, personal equipment, etc. 4 tapes for **\$3.95.** Any info can be embroidered.

Money back guarantee. All items postpaid CONUS. Send check, Money Order or Visa and Master Charge, C.O.D. (Please \$15 minimum for charging or C.O.D.) to:



Brigade Quartermasters, Ltd.

Box 108-L, Powder Springs, Ga. 30073

SEND FOR FREE CATALOGUE

Phone Orders:

(404) 943-9336

FLAK



Continued from page 7

SPECIAL FORCES REMEMBERS "BULL" ...

Sirs:

I wish to differ with Mr. Schemmer's comments regarding the Army's treatment of Bull Simons after his death ("Requiem for a Warrior," November '79). We at the U.S. Army John F. Kennedy Center for Military Assistance did not forget Col. Simons.

Nine Special Forces soldiers served as pallbearers at the Dallas funeral service. They went at government expense. These same soldiers were flown by Ross Perot to Pensacola for the memorial services there. Many of their expenses were paid by Mr. Perot.

Lt. Gen. (Ret.) William Yarborough and Maj. Gen. Jack V. Mackmull, Commander, USAJFK Center for Military Assistance, were weathered in at Fort Rucker and unfortunately missed the ceremony.

Action was initiated immediately after Col. Simons' death to name the building housing the John F. Kennedy Special Warfare Memorial Museum after him [see Bulletin Board, December '79]. Approval was received on 12 July 1979 to name the building D-2502, the museum's temporary home, Simons Hall. When the new museum building is constructed on Smoke Bomb Hill, it will be named Simons Hall.

Finally, a memorial ceremony was conducted at the John F. Kennedy Memorial Chapel at Fort Bragg on 25 May 1979.

Sincerely,

Lt. Col. Melvin H. Geiger

Public Affairs Officer

John F. Kennedy Center

for Military Assistance

Fort Bragg, North Carolina

CRANE FOR PRESIDENT ...

We all agree that 1980 is the time to change the way things are and to rid ourselves of the Carter crowd and their "Dartboard Diplomacy." There are indeed hardline conservatives who are hawks by nature. The man who fills the bill better than all others is Phil Crane. His voting record on matters of defense and international policy is the most consistent I have ever witnessed. Others who are or might be running for the presidency as "conservatives" leave much to be desired. Even the mighty Ronald Reagan has faltered (he signed the bill that now has California citizens fighting to own guns). There is also Sen. Howard Baker who is preaching the doctrine of practical foreign policy (he voted for aid to Mozambique and to ban the importation of Rhodesian chrome).

Crane stands alone as the one man who can untangle the mess that Carter has created.

Respectfully,
Guy H. Smith III
Melbourne, Florida

SOF hasn't endorsed any candidate for president as yet, but Phil Crane, whom we know personally, does seem to have a lot going for him.—The Eds.

ENGLISH MERC SPEAKS OUT ...

Sirs:

I would like to take this opportunity to congratulate you on an excellent publication, which unfortunately is unobtainable in England. Your articles are of the highest standard and most informative. They cover a wider field than any publication in England has even broached and — due to our archaic laws — is unlikely to in the future.

We mercs in this country are at a distinct disadvantage due to the laws making us unable to advertise our expertise or indeed have advertisements for persons requiring our services to answer. I have a section of 15 men, the majority of whom were Royal Marine commandos or British paratroopers, and we have to rely on word of mouth to receive offers of suitable employment. Luckily enough, we are not often out of work, but with a publication like yours in our country the scope would open.

May I once again thank you for your first-class magazine and assure you my subscription renewal is on its way to you.

Yours faithfully,
J. Estee
Riyadh, Saudi Arabia

BRONZE STAR NOT LOWLY ...

Sirs:

Regarding "Snatched from Death's Jaws" (December '79), and speaking for myself as a recipient and for those who received the award posthumously, I was both astounded and deeply angered by a reference made by the author to an award received for courage and valor as the "lowly Bronze Star."

I find it extremely difficult to believe that an individual who claims to be a combat-indoctrinated soldier could make such a statement, knowing the self-sacrifice and courage of those who were awarded the honor.

Sincerely,
M. Seler
Omaha, Nebraska

Nick Uhernik did not intend to denigrate the Bronze Star in his article. He felt, however, that the United States across-the-line policy of giving no higher award to Vietnamese personnel, regardless of merit, was unfair to Huang Khoa.—The Eds.

MARCH/80

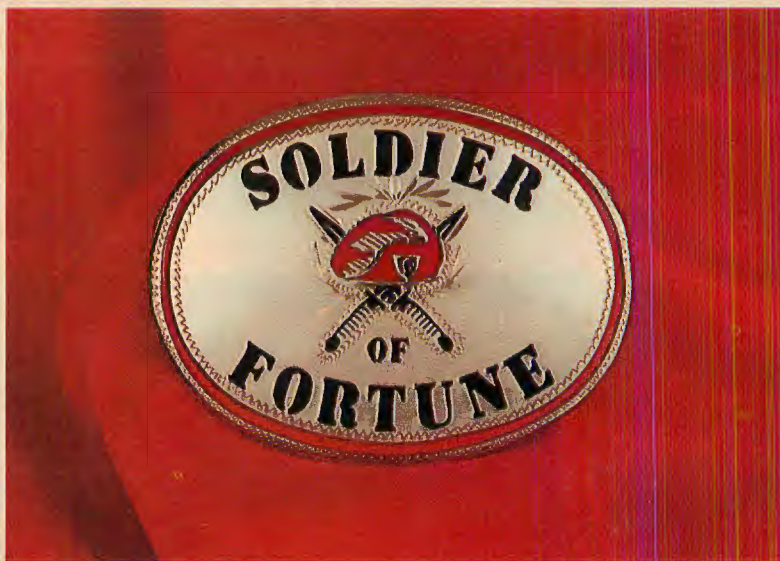

INTRODUCING THE SPECIAL EDITION SOF BELT BUCKLE! Beautiful heavy German silver buckle with handcrafted black and red SOF logo. The red border, red beret, black daggers, and black letters are acrylic and epoxy baked to a diamond hardness. This work of art is done for us by the world famous Johnson and Held Ltd company of Denver, Colorado, well known for their western and custom buckles. There will be only 250 numbered buckles in the series and they will go fast, so get your order in early! Those that wish can have their names put on a master list to reserve the same number on their buckle for the upcoming SOF specials. Collect a set of all the "specials" and you will soon have a set that will grow in value over the years. These buckles are fully guaranteed — if you are not fully satisfied with your silver SOF belt buckle, return it for a full refund.

PRICE: \$59.95



THE SPECIAL EDITION NUMBERED SOF BOOT KNIFE Designed by Al Mar of Portland, Oregon, one of the most respected knife designers & makers in the U.S., this beautifully crafted boot knife is made of 154CM stainless, full tapered tang, with black micarta handle. The blade bears the SOF logo on one side and is numbered on the other. It comes with a black leather sheath with a convenient metal clip for boot or belt, and is embossed with the SOF logo. Only 250 knives will be numbered in this series and they will go fast so order now! Make a set with the SOF buckle and register to get the same number on future "special editions." This knife is fully guaranteed; if you are not completely satisfied return the knife and sheath for an immediate refund.

PRICE: 1- 50—\$140.00
51-125—\$125.00
126-250—\$115.00



SOF PATCHES
OD & Colored—SF-13 **\$1.75**
SOF MUG
SF-15 **\$6.95**
SOF ASH TRAY
SF-15 **\$2.95**

THE SOLDIER OF FORTUNE BINDER
ONLY \$7.95

(INCLUDES POSTAGE & HANDLING)

VISA
Mastercharge
Overseas Orders add 20%
Colo. Residents add 3%

P.O. Box 693,
Boulder, Colo. 80306
Dept. SF779



Include \$1.00 for Postage and Handling.

Allow 3-4 weeks for delivery. MONEY BACK GUARANTEE

SOLDIER OF FORTUNE

BACK ISSUES



ISSUE NUMBER ONE	\$4.00	ISSUE NUMBER SIXTEEN	\$4.00
ISSUE NUMBER TWO	\$4.00	ISSUE NUMBER SEVENTEEN	\$4.00
ISSUE NUMBER THREE	\$4.00	ISSUE NUMBER EIGHTEEN	\$4.00
ISSUE NUMBER FIVE	\$4.00	ISSUE NUMBER NINETEEN	\$4.00
ISSUE NUMBER SIX	\$4.00	ISSUE NUMBER TWENTY	\$4.00
ISSUE NUMBER SEVEN	\$4.00	ISSUE NUMBER TWENTYONE	\$4.00
ISSUE NUMBER EIGHT	\$4.00	ISSUE NUMBER TWENTYTWO	\$4.00
ISSUE NUMBER NINE	\$4.00	ISSUE NUMBER TWENTYTHREE	\$4.00
ISSUE NUMBER TEN	\$4.00	ISSUE NUMBER TWENTYFOUR	\$4.00
ISSUE NUMBER ELEVEN	\$4.00	ISSUE NUMBER TWENTYFIVE	\$4.00
ISSUE NUMBER FOURTEEN	\$4.00	ISSUE NUMBER TWENTYSIX	\$4.00
ISSUE NUMBER FIFTEEN	\$4.00	ISSUE NUMBER TWENTYSEVEN	\$4.00

For further information about the contents of each issue, send a stamped self-addressed business envelope to SOF.

ORDER FORM

SOLDIER OF FORTUNE BACK ISSUES — \$4.00 EACH
PLEASE ADD 50¢ FOR EACH ISSUE TO COVER P&H

I ENCLOSE CHECK/MONEY ORDER FOR \$ _____

NAME _____

ADDRESS _____

CITY _____

STATE _____ ZIP _____

- | | | |
|-----------------------------|------------------------------|------------------------------|
| <input type="checkbox"/> #1 | <input type="checkbox"/> #10 | <input type="checkbox"/> #20 |
| <input type="checkbox"/> #2 | <input type="checkbox"/> #11 | <input type="checkbox"/> #21 |
| <input type="checkbox"/> #3 | <input type="checkbox"/> #14 | <input type="checkbox"/> #22 |
| <input type="checkbox"/> #5 | <input type="checkbox"/> #15 | <input type="checkbox"/> #23 |
| <input type="checkbox"/> #6 | <input type="checkbox"/> #16 | <input type="checkbox"/> #24 |
| <input type="checkbox"/> #7 | <input type="checkbox"/> #17 | <input type="checkbox"/> #25 |
| <input type="checkbox"/> #8 | <input type="checkbox"/> #18 | <input type="checkbox"/> #26 |
| <input type="checkbox"/> #9 | <input type="checkbox"/> #19 | <input type="checkbox"/> #27 |

RETURN TO: SOLDIER OF FORTUNE BACK ISSUES
P.O. BOX 693, DEPT. SF-29, BOULDER, COLORADO 80306



FLAK

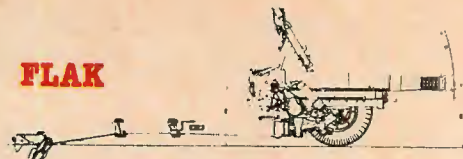

COMBAT-READY CLERK ...

Sirs:

Each month SOF is sprinkled with ads for T-shirts whose designs and wording are suitable for combat veterans, men who served in combat arms, or their ladies. How about some T-shirts for those of us who were clerks, cooks, truck drivers and the like in the Army's transportation or finance corps? We need that macho feeling too!

I was a personnel compensation specialist (SP4) in the 54th Transportation Transport Aircraft Battalion (H34 and H37) at Hanau, Germany, from 1959 to 1961 — what we lovingly called the "Brown-Boot-Dyed-Black Army." All of us clerks were armed with M1 Garands while all other EMs had M2 carbines — we clerks were obviously the first line of defense, armed as we were. I dream of owning a T-shirt with "Combat-Ready Clerks" emblazoned across it and a crossed rifle and file cabinet design. A "Remington Raiders" shoulder sleeve tab would be a nice touch too!

Sincerely,
Peter Hendrickson
Alamogordo, New Mexico

We've passed your suggestion on to Phoenix Associates — now it's up to them. — The Eds.

1ST CAV INFO SOUGHT ...

Sirs:

I'm writing to ask your help in finding the mailing address for the 1st Cav. Division Association of which I'm a life-time member.

I found your article on Bobby Garwood (September '79) interesting, as I served in Vietnam with the 1st Cav. (1965-66) about the time he disappeared. I personally feel he was a traitor and should be treated as such.

I believed strongly in what I did there and still do. The only bitterness I feel is toward the people that sold us down the river. If people only knew how they sold out our beliefs and the friends we lost defending them!

Sincerely yours,
Fred Devens
Fort Myers Beach, Florida

You can get the information you need by writing the Office of Public Affairs, First Cavalry Divison, Fort Hood, TX 76541. --The Eds.

MUTUAL PRAISES ...

Sirs:

My article looked great ("Whispering Killer," November '79). I was discussing it with Glenn Helgeland, editor of *Archery World*, and the discussion got to SOF itself. Glenn and I both said we were brought up on the adventure stories of *True, Stag, Male*, etc., and I commented that SOF takes their place. We both agreed that their void needed filling. There were adventurers out there but nothing to inspire them. SOF is now taking care of that.

Sincerely,
Jack Bowman
Piqua, Ohio

CROSSBOW ADDRESS ...

Sirs:

Your November 1979 issue carries an article, "Whispering Killer," by Jack Bowman. I'm interested in purchasing a crossbow and would like the addresses of Horton of Scotland and also B.P. Barnett.

Thank you,
S.J. Dzakouski
Glen Cove, New York

To Mr. Dzakouski and the dozens of readers who've written us, asking for this information, the Barnett "Wildcat" and "Commando" can be purchased from B. & P. Barnett (Canada) Ltd., 66 Tumbleweed Cr., London, Ontario N6E 2N8 Canada. The Horton "Safari" and "Magnum" are available from Horton Crossbows Ltd., Peddieston, Nr. Cromarty, The Black Isle, Scotland. — The Eds.

OTHER BORDERS, OTHER PATROLS ...

Sirs:

I deeply enjoyed your article on the Korean DMZ ("Korean Combat of Nerves," December '79). But what about the men who patrol and secure the Czech and East German borders? Our job is just as important as that of the men on the DMZ. Keep up the good work.

Sincerely yours,
Sp4 Thomas A. Bisping
Troop C, 1st Squadron,
1st Cavalry
APO, New York, New York

WE DIDN'T LOSE 'NAM ...

Sirs:

I am pissed! I've had it with this crap that the U.S. military lost the war in Viet-

Continued on page 85

THIS BOOK PREPARES YOU FOR TERRORISM, FOOD SHORTAGES, MONETARY COLLAPSE, A DICTATORSHIP, AND GUN CONFISCATION!!!

TIMELY AND PROFITABLE HELP FOR TROUBLED AMERICANS hits the bull's-eye! In its survival expert Hans J. Schneider reveals his proven plan for YOUR freedom and survival in the midst of economic and civil turmoil.

An extraordinary life uniquely qualified Hans to write it **JUST FOR TIMES LIKE THESE!** He endured much physical suffering and privation under two dictatorships, including 5 years under Communism. As his country struggled through another economic and political crash, a serious illness almost took his life. His father, a former industrialist, lost about \$10 million overnight, was imprisoned and told that he would be shot the next day.

As thousands of a disarmed populace were murdered, conditions were so severe that they had to arrive at ingenious ways to survive, and solve food and clothing problems . . . let Mr. Schneider tell you about it.

Having survived terribly adverse circumstances many times, he knows **first hand what worked and what did not.** Why endure like hardships if you can learn from a man of such caliber? This invaluable knowledge will help you in similar times ahead.

Chapter 19, "Emergency Short-Term Survival," alone can save the lives of you and your loved ones. It is a crash course in the most essential areas if time is of the essence and things are caving in around you. In it the author gives you the best and most comprehensive food test derived from his own experience and in-depth research of various survival manuals. Also included is an abbreviated version taken from the Air Force Survival Manual. Knowledge of these tests is a MUST. The same lifesaving chapter will show you what to do when you get lost in the wild country, or if you were relocated from where you NOW live, and how to provide almost instant shelter and heat. You will receive vital information on survival hunting, unusual remedies, first aid, and orientation. Lists of survival manuals and essential items for the survival kit (most of which can be obtained locally and easily carried with you in times of emergency) are included.

- Now discover how you can:
- * Beat inflation and depression.
 - * Protect and increase your savings by proper investments.
 - * Choose an exciting occupation least vulnerable to unemployment.
 - * Succeed in your own business.
 - * Make money, cut expenses, save time.
 - * Get out of the rat race.
 - * Live simply for LESS and enjoy it MORE.
 - * Locate your place of refuge (things to look for, what to avoid).
 - * Be completely independent when energy sources give out by producing your own electricity without gasoline 5 different ways.
 - * Prepare for the coming agricultural woes.
 - * Get in top physical condition with the right type of diet for your geographical location and lifestyle.
 - * Protect yourself from auto repair gimmicks and skyrocketing crime.
 - * Give your children a meaningful, thorough education in 2 hours a day without exposing them to dope, delinquency, racial problems and bad teachings.
- ... and much, MUCH more.

Mastercharge BankAmericard/VISA accepted.



© 1978
WWPC

DO YOU KNOW???

What essential provisions to store, and how some can be used for barter? . . . What weed has a tremendous healing action for wounds and sores (page 45)? . . . Which animals are the most productive, economical and easiest to care for? . . . What advantages the Southern Hemisphere has to offer? . . . Why Hitler's on-rushing military might never invaded Switzerland? . . . Why big cities will be places of increased terror in the coming years? . . . What usually follows gun registration? . . . Which investments will be a disaster in the near future? (Believe it or not, but the funds of many Americans are tied up in these.) . . . Why your savings accounts could be wiped out overnight?

Find the answers in 180 different concise sections. You will also read about alternate lifestyles, weaponry, and defense tactics; 7 ways to get out of debt (page 94); 5 ways to identify "shady" businesses; 6 simple, inexpensive ways to preserve your own food (one using just a needle and string! page 47); and what is even more important for your physical survival than merely storing food (see pages 214 and 248-249!).

Are you sick of it all? The rat race, pressures of modern-day living? Do you ever long for independence, your own home in the country with peace and quiet? THIS IS THE BOOK FOR YOU!

You'll find out how you can wisely select the right place to live in the stormy times ahead, using the 3 "acid tests," his own unique, proven approach—just like Mr. Schneider did! He lives in a beautiful place situated in the mountains by a spring-fed creek without utility bills, polluted air, chemicalized food, and noise.

Ever considered moving to another land? The author, who has lived abroad and travelled in nearly 100 countries, gives you the facts you need to know before incurring the formidable expense and effort of emigrating. He even explores yachting as a means of survival and a way to see and live all over the world.

Within its 288 pages, find how you can turn problems into advantages, miseries into happiness, boredom into challenge, and time waste of a merry-go-round existence into a purposeful life.

In short, you'll discover in this book how to live better today and be more prepared for tomorrow. This valuable survival/investment manual can be yours for just \$9.95 ppd.

Mr. Schneider is also the author of 2 other excellent books. His latest, **FLYING TO BE FREE** (256 pages), is his personal never-before-told story of the years he spent on dangerous aviation missions through war-torn Europe and the near-fatal accounts of his travels in almost 100 countries. **MASTERS OF LEGALIZED CONFUSION AND THEIR PUPPETS** (65,000 copies in print!) is an undisputed eye-opener written without compromise. These volumes will make wonderful additions to your library. Now ALL THREE books can be obtained for just \$15.95 ppd.—\$4 OFF (a 20% savings)! Prompt shipment guaranteed.

Write your name, address and the desired sets on a plain sheet of paper and send with your check or money order to:

**WORLD WIDE PUBLISHING CORP., Dept. 29
P.O. Box 105, Ashland, Oregon 97520 U.S.A.**

THE ULTIMATE IN SURVEILLANCE!



K-88 FORWARD RECON. SCOPE

- See them long before they see you! ... If they ever do, it will be up to you and on your terms!
- So powerful are these optics that you can **identify a vehicle** at 6 miles! ... **Identify aircraft** at 22 miles! ... **A sentry's weapon** at 4 miles!
- Can be used as a **telephoto lens** as well! (Specify your current 35mm SLR and add \$25)
- Field Model comes complete with mini-pod, erecting prism, case, and 36x eyepiece (add \$30 for 100x eyepiece)

LIGHT AMPLIFYING POWER =
160x HUMAN EYE
AVERAGE MAGNIFICATION =
36x100x
EFFECTIVE FOCAL LENGTH =
1000mm (40 inches)
TUBE LENGTH =
200mm (8 inches)
TUBE DIAMETER =
125mm (5 inches)
CLEAR APERTURE =
90mm (3.5 inches)
WEIGHT = 4 lbs.
PRICE: \$295.00 ppd.

Send Cash, Postal Money Order, Certified Checks ONLY or Master Charge, Visa, or American Express number to:

R.M.S. INC
P.O. BOX 4489
BOULDER, COLORADO 80306
U.S.A.
QUANTITY PURCHASE
INQUIRIES INVITED

Adventure Quartermaster

N.E. MacDougald



STOCK ANSWER

Parellex Corporation, Dept. SOF, Box F, Chicago Ridge, IL 60415, manufactures a folding stock for Ruger's Mini-14 (series 180 only). The walnut stock features a black resin pistolgrip. According to the maker, all metal parts are precision machined and hand fitted. The stock pivots to the right a la Israel's Galil or the Swiss SG 543 and locks in both closed and open positions. The two-pound paratrooper stock retails for \$99.95.

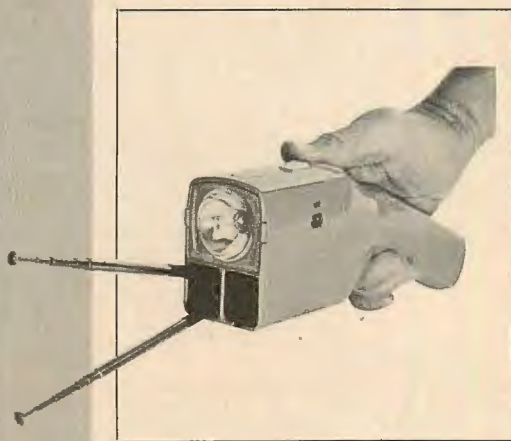

GIVE ME A BUZZ

Quality Creations, Dept. SOF, 2801 Biscayne Drive, Youngstown, OH 44505, announces an accessory Probe-Pak cassette for the Taser Electronic Defense Weapon. The Probe-Pak transmits the Taser's pulsating current upon contact with the antenna-like probes. The telescoping probes extend from 3½ to 20 inches and can be used repeatedly. Suggested uses are crowd or prisoner control. Retail price is \$19.95.

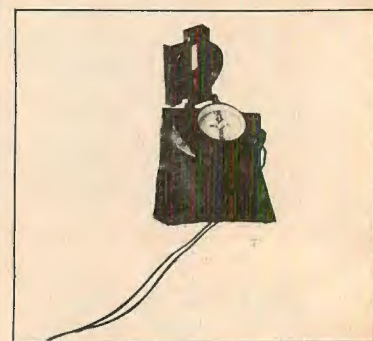

GET YOUR BEARINGS

Stocker and Yale, Dept. SOF, Beverly, MA 01915, manufactures the lensatic military-style compass, modeled after the U.S. Army version. Designated Model J-277, the compass has an aluminum case painted olive drab. A luminous line on the bezel lines up with luminous marks on the cover. Damped by an inner copper shell, no fluid is used in the compass. It measures approximately three by two by one inch, and weighs 142 gr. Retail price is \$34.95 plus \$2 for the O.D. nylon case.

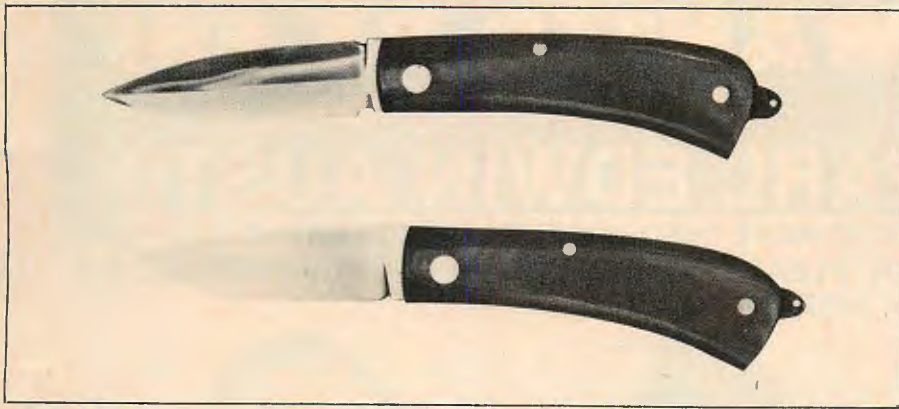

LITTLE WEIGHT, BIG WAIT

A.G. Russell Co., Dept. SOF, 1705 Highway 71 N., Springdale, AK 72764, makes two Airweight folding knives. The double-ground Airweight folding bootknife retails for \$135, while the single-edged Airweight folding hunter retails for \$120. Both blades are high-carbon stainless hardened to a Rockwell of 60 on the C scale. The 1/8-inch blade is 3-1/8 inches long. Handles are black or medium-red Rucarta. The knife measures 7 1/4 inches open and 4-1/8 inches closed. It weighs but 2 1/2 oz. Delivery time for the handmade Airweight is 18 months minimum.

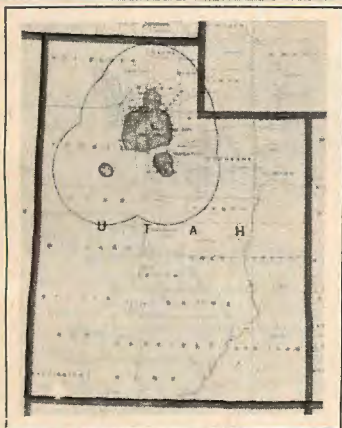

MACABRE MAP

Nuclear Emergency Services, Dept. SOF, Box 34863, Los Angeles, CA 90034, produces a nuclear disaster map. The map illustrates the likeliest areas where nuclear strikes may occur. Dark sections indicate blast areas and outlying circles indicate areas where fallout will probably kill within an hour. Maps retail for \$65 and wholesale for \$45. A free brochure of NES products is available upon request. It includes radiation survey meters, anticon-tamination kits, dosimeters, probes, etc.



STAINLESS SELFSTUFFER

Detonics .45 Associates, Dept. SOF, 2500 Seattle Tower, Seattle, WA 98101, has just announced their stainless steel Combat Master Mark VI. The weapon functions like the first five models, but is investment cast of various stainless steels. The Mark VI features a unique three-dot sight that, according to Detonics, quickens target acquisition. The .45 weighs 29 oz. empty and 35 oz. loaded. It retails for \$575.

AN/COM ELECTRONICS

INTRODUCES
THE SUCCESSOR TO
THE AN/PRC-6

THE AN/PRC-6T

AN ALL SOLID STATE VERSION
OF THIS WORKHORSE
PORTABLE THAT SETS A NEW
STANDARD OF PERFORMANCE
& RELIABILITY



- UP TO TEN TIMES THE LIFE OF OF THE BATTERY/TUBE MODEL
 - TAKES STANDARD OR ALKALIDE 'D' CELL
- UP THE RANGE OF STANDARD AN/PRC-6
 - GREATER RECEIVING SENSITIVITY
- RUGGED WATER PROOF CASE REBUILT TO MIL SPEC
- ACCEPTS STANDARD PRC-6 CRYSTALS

REFINISHED TO GOV'T SPECS
CONVERTED TO ALL SOLID
STATE

\$150.00

ALL ITEMS SHIPPED PREPAID

AN/COM
ELECTRONICS

5521 CLEON, NORTH HOLLYWOOD,
CA 91601 (213) 769-5518

SUPER KNIFE SPECIAL

Compare These Prices Anywhere

- 19" overall
- 15" edge
- steel blade
- canvas sheath



A BUSHWHACKER

B MACHETE

C BOLO MACHETE

- 23" overall
- 18" edge
- steel blade
- canvas sheath

- 20" overall
- 18" edge
- steel blade
- canvas sheath



D SAWTOOTH MACHETE

E HATCHET

- wooden handle
- 15 1/2" overall
- 2 lbs.

- fiberglass handle
- 13 1/2" overall
- 1 1/2 lbs.

F CAMP AXE

G COMBAT KNIFE



H MARINE KNIFE

- 10 1/2" overall
- 5" edge
- steel blade
- sheath

- 12" overall
- 7" edge
- steel blade
- sheath

LIMITED TIME OFFER

ONLY

\$5.95

Each

Plus Postage

- 9 1/2" overall
- 5" edge
- steel blade
- sawteeth on back
- sheath
- whetstone

I SURVIVAL KNIFE

Please send me _____ knife(s) at the Limited Time Offer of \$5.95 each or \$5.00 each in quantities of 3 or more. Add \$1.00 postage for first knife and 50 cents for each additional knife. Make checks or money orders payable to TIFFIN INTERNATIONAL.

Knives Available (Enter number(s) desired)

Quan.	Quan.	Quan.	Quan.
A _____	C _____	E _____	G _____
B _____	D _____	F _____	H _____
			I _____

Name _____
 Address _____
 City _____ State _____ Zip _____
 _____ VISA _____ MASTER CHARGE
 Exp. Date _____ Card Number _____
 Signature _____

Mail to: TIFFIN INTERNATIONAL,
 P.O. Box 881, Dept. SF-3 Clanton, AL 35045.
 Dealer Inquiries Invited

BANK ROBBERY, PAROLE VIOLATOR
WANTED BY FBI
 (And SOF Magazine)
EARL EDWIN AUSTIN

IF YOU HAVE INFORMATION CONCERNING THIS PERSON, PLEASE CONTACT YOUR LOCAL FBI OFFICE OR SOLDIER OF FORTUNE.



Unfortunately we weren't at our bank in late October 1979 when Earl Edwin Austin robbed it of \$236,500 and escaped by car. If we had been, we wouldn't need to ask you to help us locate him.

SOCIAL SECURITY NUMBERS USED:
 232-44-1461; 493-48-6825; 497-44-5512;
 497-44-5842

CRIMINAL RECORD

Austin has been convicted of grand larceny, forgery, aggravated assault and battery, bank robbery, escape and threatening the life of the President of the United States.

CAUTION

AUSTIN, WHO HAS ESCAPED FROM CUSTODY ON NUMEROUS OCCASIONS AND SHOT AT LAW ENFORCEMENT OFFICERS IN THE PAST, IS BEING SOUGHT IN CONNECTION WITH A SERIES OF ARMED BANK ROBBERIES. AUSTIN HAS BEEN DIAGNOSED AS HAVING A SERIOUS PERSONALITY DISORDER AND ALLEGEDLY HAS SUICIDAL TENDENCIES. IN THE PAST AUSTIN REPORTEDLY STATED HE WOULD NOT BE TAKEN ALIVE. AUSTIN IS BELIEVED TO POSSESS NUMEROUS WEAPONS AND SHOULD BE CONSIDERED ARMED, EXTREMELY DANGEROUS AND AN ESCAPE RISK.

ALIASES: Earl Austin, Carl H. Barber, Earl Bibler, Louis Clayton Bibler, Thomas Hugh Carter, Daniel R. Clark, Louis Draper, Clarence Kolka, Louis Kreyer, Gerald M. Morgan, Gerald M. Reardon, William J. Sanders, and others.

DESCRIPTION

AGE: 37, born 14 December 1941, Takoma Park, Md.
HEIGHT: 5'9" **EYES:** blue
WEIGHT: 140 lbs. **COMPLEXION:** light
BUILD: medium **RACE:** white
HAIR: brown **NATIONALITY:** American
OCCUPATIONS: barber, cook, carpenter, laborer, salesman, tugboat deck hand
SCARS AND MARKS: scars bridge of nose, left thumb, left arm and right elbow; tattoos: arrow and "KCMO" upper right arm, mouse right forearm, knife handle left arm.
REMARKS: reportedly a compulsive gambler; has five teeth missing and usually wears dentures; wears toupees.

"... WHO KNOWS WHAT EVIL ..."



Prepare yourself with Shadow Systems' ultra-concealable rig for mini derringers. The soft black leather pocket wraps around your ankle, leg, wrist or arm and is held securely in place with a Velcro closure. You'll never know you have it on... 'till you need it.

To Order send \$11.95 to:
SHADOW SYSTEMS
 P.O. BOX 28222 - SOF
 ATLANTA, GA. 30328

BULLETIN BOARD

Continued from page 13

Pirie stated the administration seeks lifting of the ban not so it can put women into specific combat jobs but to give the services flexibility to assign women more combat-related jobs.

He said it would enable women to serve on combat ships and fly combat jets although he doubts women would be assigned to actual combat missions. A major reason for dropping the ban, Pirie said, would be to allow women into more combat-related jobs that now help men get promoted.

Maj. Gen. Holm said women can fly combat jets, serve on combat ships, and fire missiles and artillery — any job that requires skill rather than muscle. Holm also stated that women can handle the stress of combat as well as men with the same training.

But she said, "I have great difficulty with women serving in ground combat."

"I think there is a general objection to women serving in close combat," said White, who predicted "tough-sledding" for the attempt to lift the ban.

MILITARY BOOK BONANZA ...

Editor/Publisher Robert K. Brown visited Sky Books International (48 East 50th St., New York, N.Y.) recently and found one of the most comprehensive and extensive selections of military books he has ever come across.

Sky Books carries a minimum of 5,000 military titles, the largest in the New York Metropolitan area. They have a single retail outlet and are open six days a week, from 10 a.m. to 7 p.m.

David Daniel, the firm's consultant and assistant manager, who is working on his doctorate in military history, says the firm would be happy to send flyers to any interested party. Brown stated that it would be well worth the time of anyone who is interested in military subjects to drop by.

NEW TERR MAGAZINE ...

TVI Journal, Box 1307, Boulder, CO 80306, a new publication devoted to the study of terrorism, violence and insurgency, got out its premier issue in November.

Publisher Peder C. Lund is directing it to government officials, business executives, security agents, law

enforcement officials and criminologists worldwide by subscription only (one year \$135, two years \$235).

The purpose of the journal, says Editor Mark Monday, is "... to provide a synthesis of the operational and theoretical aspects of counterterrorism activities, and provide a common means of communication among the various professionals in the business. From social scientists to corporate security agents ... We are all different forces in the same war. We have much to gain from listening to each other."

The editorial features appearing in the bi-monthly, 21-page journal (a news update is issued on alternate months) are written primarily by guest contributors. In addition, the journal presents a variety of regular features, including an incident analysis report, reviews of important books, a listing of seminars, reader's forums and an update on the latest technologies of prevention and protection.

Primary topics the journal expects to cover will be police science, terrorist group profiles (philosophy, goals, financing, targets and techniques), the vulnerability of our society, technology of terror, sociological

Continued on page 29

SOUTHEASTERN SURPLUS DOES IT AGAIN!

BRAND NEW Original Military Issue All Wood Footlockers. Very hard to get, genuine, and perfect for thousands of uses. Unissued goods.

SPECIFICATIONS: FEDERAL STOCK NUMBER — 8460-243-3234. DIMENSIONS — 32" x 16" x 13". COLOR/SHADE — OD, Shade 108. ACCESSORIES — Padlock W/2 keys, Plywood Interior Tray. CONSTRUCTION — All plywood, Top — 1/2", Sides — 3/8", Tray 1/4", steel reinforcements throughout; 3 steel hinges on lid. WEIGHT — 25 lbs. **PRICE — \$35.15, FREIGHT — \$3.00** East of Mississippi River, \$5.00 West of Mississippi River.

OTHER SOUTHEASTERN SURPLUS BARGAINS

- Genuine U.S. Military OD Jungle Fatigue Jackets in Rip-Stop poplin. All sizes in stock from X-Small Short to Large Long. Used, in excellent condition \$10.00 ea. Sorry, no pants.
- Genuine U.S. Military Snow Camouflage Rucksack Covers (White). Very hard to find item, in excellent like-new condition, Artic Troop Issue. Genuine, and rarely seen in any condition \$ 5.75 ea.
- Original, Current, LC-1, Collapsible Entrenching Tools. Manufactured in the 1970's. Original government goods. Used, in excellent condition \$13.65 ea. Covers available, in combat serviceable condition \$ 1.40 ea.
- U.S. Military Regulation 100% Wool Berets, available in Ranger Black, Special Forces Green, USAF Security Police Blue. Guaranteed original and genuine. All sizes, brand new \$ 9.00 ea.

SHIPPING: Footlockers can be shipped *only* to original 48 states. Other items shipped anywhere in the Free World. This offer expires April 1, 1980 or until quantities are sold.

TERMS: Payment with order, please. Money Orders and Cashier's Checks preferred. Personal checks OK, but held 3 weeks for clearance. We accept VISA and MASTER CHARGE. Include cardholder's name, full account number, and expiration date. Orders sent without freight charges will be returned.

CATALOG: Send \$1.00 for current 60-page, photo-illustrated 8 1/2 x 11" CATALOG/REFERENCE MANUAL CRMS-1. Full of U.S. Military Clothing and Tactical Equipment. The finest publication of its type in the industry.

Southeastern Surplus, Inc., 7228-A Highway 85 Riverdale, Georgia 30274 U.S.A. (404) 997-6515

PRICE — \$35.15



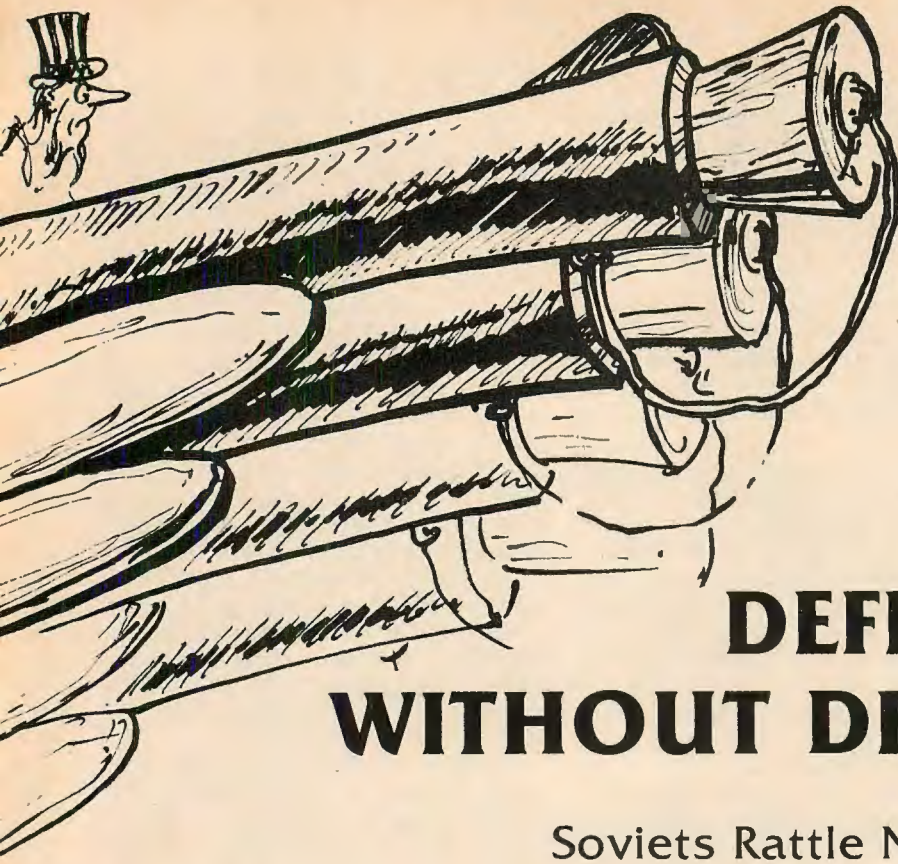

DEFEAT WITHOUT DESTRUCTION

Soviets Rattle Nuclear Saber

FEAR DEFEAT, NOT DESTRUCTION

No fireball? No uncontrolled war? Yet Uncle Sam's on his knees before the Russian bear.

This almost bloodless scenario conflicts with everything I've read in the last 20 years. And the strategy's ruthless pragmatism scares me most. But then, Machiavelli should be a communist folk hero.

If you covet your neighbor's house and want it for yourself, would you risk burning out the present owner? If you covet your neighbor's wife, would you risk killing her to take her away from her husband? No. Then why should the Soviets risk ruining the West? They want to take over, not start over.

This article is taken from Gary North's newsletter, *Remnant Review*. If it frightens you, put that fear to use by contacting your government representatives.

The author has chosen anonymity because of a sensitive position in Washington. Gary North has staked his reputation on the author's credibility. Not knowing the author, I cannot do the same. But I can say the piece is one of the best written and best researched I've read in years.

—N.E. MacDougald

IF the Soviet Union were to inflict a nuclear first strike upon the United States, well over 90 percent of the American people would read about the attack in their newspapers, or hear about it on radio or TV. Only a small percentage of Americans would see, hear, or feel any effects of the attack, and considerably less than one percent of us would become casualties. This is not wishful thinking, but rather a sober, detailed appraisal of the effects of the Soviet nuclear weapons which exist or are being built, if they were used according to the military strategy which the Soviet Union has been teaching to its forces.

If the Soviet Union were to inflict a nuclear first strike upon the U.S., 90% of the American people would read about the attack in their newspapers.

Soviet weapons are made especially to destroy American weapons — to defeat America while killing very few Americans and leaving our economy intact. Simply put, the Soviet Union is not out to destroy us, but to defeat us. We can take no comfort in this, because the Soviets have made tremendous strides toward being able to achieve this goal, and because, after being defeated by the Soviets, most Americans might wish that Armageddon had come instead.

The popular American picture of nuclear war is utter nonsense.

All of this, of course, is contrary to the picture of nuclear war which has been propagated by most American politicians, academics, and publicists for a generation. According to their view, nuclear war would be a spasmodic exchange. Both the U.S. and the USSR would shoot everything they had at each others' centers of population, literally bombing each other back into the Stone Age, or worse. Neither country could or would take any care, before or during the conflict, about limiting damage to itself. Each would strive only to annihilate the other even as it was being annihilated itself. As song writer Tom Lehrer once put it, "We will all go together when we go." This very popular and reassuring view is shared by people as different in their political preferences as George McGovern and Barry Goldwater.

The popular American picture of nuclear war has always been utter nonsense. Nonetheless, the technological advances of recent years have made it even more criminally stupid. First, the military capacity of the two sides has never been equal. During the 1950s, had we gone to war with the Soviets, nearly all our bombers would have gotten through to Soviet targets, while very few Soviet ones

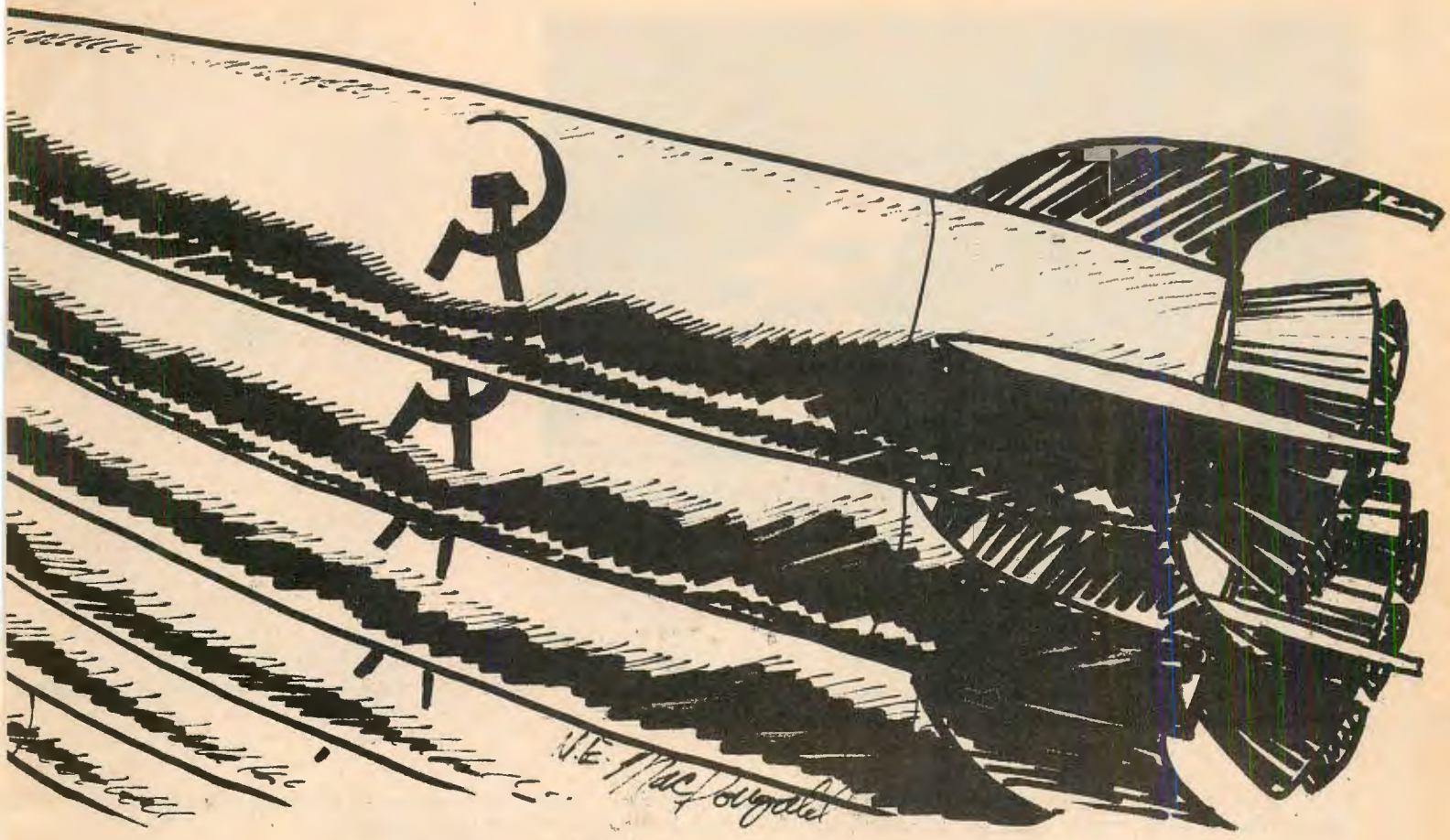

would have made it to our borders. During the 1960s, our missiles, inaccurate as they were, could have knocked out the Soviets' few missiles, which were then located on soft pads well known to our satellites. During the remainder of the 1960s, when both we and the Soviets placed our missiles in hardened silos or submarines, there was some reason to believe that we and the Soviets were equally targeting each others' population but it was not so.

We targeted industries, while the Soviets targeted our air and naval bases. But we had a bigger force. Had we gone to war in the late 1960s, we would have lost most of our military power, while the Soviet Union would have lost a fourth of its population and less than half of its industry. Since the early 1970s, it has been beyond dispute that the Soviet Union has a superior ICBM force built for one primary mission: destroying American missiles in their silos. (Roger D. Speed, *Strategic Deterrence in the 1980's* [Stanford: Hoover Institution, 1979].) By so doing the Soviet Union can diminish the United States' ability to strike back with its population-killing weapons.

The American image of nuclear war as Armageddon is false.

So, to sum up, at different times either side has had finite military ability to defeat the other and protect itself. Second, and most important, the American

image of nuclear war as Armageddon is false because while American planners, beginning with Robert MacNamara, have disapproved of destroying enemy weapons, and have not attempted to design plans which might allow the U.S. to survive a nuclear war, the men in charge of the Soviet military establishment have never wavered from the view that wars have winners and losers and that the job of the Soviet military is to protect the Soviet Union by smashing the enemy's weapons.

Thus while American policies have aimed at producing dead Russians while leaving intact Soviet strategic weapons, the Soviet Union has never targeted our population. (Fritz Earmarth, "Contrasts in American and Soviet Strategic Thought," *International Security* [Spring, 1978].) As a result of our misperception, we have been worrying needlessly about being burned to a crisp, or about dying of radiation sickness (a la the movie *On the Beach*). We have worried ourselves so irrationally about a far-fetched danger that we have rendered ourselves incapable of doing anything about the present danger — the Soviet Union's growing ability to defeat us and to do to us what it has done to other peoples it has conquered.

At the time of the Cuban missile crisis in 1962, the Soviets had less than 10 SS-6 intercontinental missiles capable of striking the U.S. These lumbering giants were aimed at the U.S. Air Force bases. They were dangerous above all to the people

who had to pump fuel into them. Today, Soviet missiles capable of reaching the U.S. number at least 2,400 modern types. (All figures for strategic deployments are taken from the book edited by Paul Nitze, *The Fateful Ends and Shades of SALT* [New York: Crane Russak & Co., 1979].) We must say "at least" because we really have no idea just how many missiles the Soviet Union has built and stored, ready for use.

The Soviets have always refused to let us examine their facilities for producing missiles, while the United States' vaunted intelligence satellites simply cannot look through roofs, or darkness, or clouds. Nor can they overhear anything that is not broadcast in the clear.

Nevertheless, at the beginning of the SALT negotiations 10 years ago, the U.S. agreed to believe officially that the Soviets had only as many missiles as they had silos in the ground and in launcher tubes on submarines. Thus the SALT treaties have not limited the production of missiles, but only the deployment of things which American intelligence can count — silos and submarines. At any rate, regardless of the missiles they might have hidden, 2,400 is the number of missiles and bombers the Soviets have openly deployed.

At least 326 of these missiles are SS-18s. These carry 10 independently targeted warheads, each of which has a yield of about one megaton — one million tons of TNT. (This is a highly tentative estimate, because the U.S. really does not under-



Ancient B-52 is U.S. mainstay bomber, built between 1954 and 1962, making some pilots younger than their planes. The much maligned B-1 was expensive, but what price freedom?



Soviet TU-95 Bear bomber houses sophisticated radar.

stand how Soviets build nuclear weapons.) These 3,000+ Soviet warheads carry more explosive power than the entire American missile force put together. These warheads by themselves are also sufficient to cover every American "hard target" twice over. They would have to be because prudent planners assign two warheads to critically important targets — such as missile silos and "command and control" points — which have been armored to resist nuclear explosions.

Soviet SS-18 warheads are accurate enough to place their megaton within 1/10 mile of the target. They go a long way toward disarming the U.S.

The United States has less than 1,500 such sites overall, each able to resist pressures of 1,000 pounds per square inch. (Figures for hardness of American and Soviet silos are reported in *Counterforce Issues*, published by the Congressional Budget Office, 1978.) The SS-18's warheads are accurate enough to place their megaton within about one-tenth of a mile of the target — close enough to be quite sure of killing it. (Performance data for Soviet and American missiles are from *Jane's Weapons Systems*, 1978-79.) The SS-18s alone can go a long way toward disarming the United States.

The Soviet Union earlier has deployed or is now deploying 500 SS-17s and SS-19s. These missiles carry four and six warheads respectively. Though not quite so accurate as the 18s, these 2,500-

megaton-size warheads could kill "hard targets." But they could also be used to destroy "soft" military targets such as air bases, or be kept in reserve to threaten cities.

Soviet subs will have over 2,000 warheads by the early 1980s.

In addition, there are almost 600 SS-11s, each carrying one megaton. The Soviet Union has also deployed some 900 missiles aboard submarines. Almost half of these are longer range than anything aboard American ones, and about 200 of these carry multiple warheads. By the early 1980s, the latter's number will rise to about 500. The Soviet submarine force should be expected to have over 2,000 warheads, each of which would yield between 500 kilotons and one megaton. Such warheads, however, are only accurate to within a half mile. Therefore they can be used to attack air bases or to threaten cities.

Soviet civilian cargo planes could be used to bomb the U.S.

The Soviet heavy bomber force is small — less than 150 operational Bears and Bisons. Yet it can easily be augmented by 200 Backfire medium to long-range bombers, or even by cargo aircraft. The reason is simple: Soviet aircraft seeking to drop bombs on the U.S. need not use speed, low altitude, or deception to counteract American air defenses, because none exist. They have been dismantled over the past two decades.

Even civilian cargo planes could be used to bomb the U.S.!

The Soviet Union, on the other hand, has deployed 6,500 air-defense radars, 10,000 interceptor missiles, and 2,600 interceptor aircraft. It practices air-defense constantly. It has also built four huge phased-array radars which can be the core of a nationwide defense against ballistic missiles. The other components of such a defense already exist. The Soviet Union has but to mass produce them — which, for all we know, it may be doing — in order to have a respectable defense. To back up its active defenses, the Soviet Union has an expanding civil defense, featuring hard shelters for about one-fourth of the urban population, protection for vital industries, and sheltered food supplies.

The backbone of the American force is the Polaris-Poseidon fleet.

The backbone of the American force is the Polaris-Poseidon fleet. These 41 submarines carry 16 missiles each — a total of 656 missiles, which can carry some 5,000-5,400 nuclear warheads. About half of this force — some 2,500 warheads — is at sea at any given time. Most of it could survive any Soviet attack.

But the Polaris-Poseidon warheads are curious weapons. They yield only 40 kilotons each, and are accurate to about four-tenths of a mile. Thus they are optimal for attacking soft targets, such as residential areas. They are less useful for



Soviet 201-M Bison bomber with U.S. F-4 Phantom II fighter in background.

military targets, and totally useless against "hard" targets. This is by design. As Poseidon was being perfected, Secretary of Defense Robert McNamara rejected plans to fit it with three big, accurate warheads, on the grounds that the ability to strike "hard targets" was against America's strategic policy.

That policy, simply put, is to deter war by threatening to kill Soviet civilians in a second strike. According to that policy, any weapon which can destroy missile silos makes war more likely because it gives its owners several militarily rational options — including a first strike. The objective of nuclear strategy, according to people such as Robert McNamara and the Carter administration, is to make war wholly irrational for all concerned. The Poseidon, with its many, small, inaccurate warheads, is certainly an irrational weapon.

Minuteman IIIs have but slight chances against Soviet silos.

The 1,000 Minuteman IIs and IIIs are spread in silos at the following Air Force bases: Grand Forks, N. Dak.; Malmstrom, Mont.; Whiteman, Mo.; Warren, Wyo.; Minot, N. Dak.; and Ellsworth, S. Dak. There are 54 Titan IIs located at Davis-Monthan AFB, Ariz., and Little Rock AFB, Ark.

Even the best of these, the 550 Minuteman IIIs, have but slight chances against Soviet silos and military communications centers "hardened" to some 2,500 pounds per square inch. These missiles then can best be used against in-

dustrial targets and relatively soft military ones. But, since the Soviets have weapons capable of destroying them on the ground, these missiles may do nothing more in wartime than "soak up" Soviet warheads.

America's B-52 bombers are older than the pilots who fly them.

The American bomber force is old. Its mainstay, the B-52, was designed during the Truman Administration. President Carter cancelled production of its successor, the B-1. The B-52s in service are older than the pilots who fly them. Some 300 B-52s are flyable. Each carries about four bombs. In the future, they may carry cruise missiles. One-third of the B-52s are on ground alert at some 25 bases. If the Soviet Union attacked these bases with submarine-launched missiles, and also barraged the bombers' escape corridors, not many would survive to try their luck against Soviet air defenses.

American defenses are practically nonexistent. The old Distant Early Warning (DEW) line of arctic radars is obsolete. Anyone with a terrain map of northern Canada can figure out the holes in it. Once a Soviet pilot gets through that, he can be confident of flying to his destination undetected. Even if he were detected, little could be done. The U.S. has only 300 old F-106 interceptors, and no surface-to-air missiles deployed to defend the country. The U.S. has developed excellent technology by which to defend against ballistic missiles, but has renounced its

use. According to American strategic doctrine, safety lies in mutual vulnerability. So far do American officials adhere to this doctrine, that the U.S. is wholly without civil defense. There are practically no blast shelters in the U.S. and certainly no strategic storage of food.

It is clear that the biggest difference between the Soviet and the American force — bigger than the differences in hardware — concerns the purposes for which the weapons may be used. Soviet military writings refer to deterrence quite differently from American ones. Whereas American defense intellectuals see the weapons as scarecrows by which to ward off attack on American cities, the Soviets see them as tools by which to achieve their ends. Thus, for them, deterrence is an offensive concept: that is, to keep the Americans from thwarting Soviet purposes. For them, deterrence is achieved by the ability to win the war. (J. Douglas and A. Hoerber, *Soviet Strategy for Nuclear War* [Stanford: Hoover Institution, 1979].)

The Soviets expect that the U.S. would be deterred from doing anything serious to stop the ultimate triumph of the Marxist "Socialist Commonwealth" by the following prospect. If pressed too far, the Soviet Union could launch its force of SS-18s and therewith destroy nearly all American land-based missiles and bombers. At the same time, Soviet ships or aircraft would mine the harbors where half of the American Polaris-Poseidon submarines lay. This would put the submarines out of action, and keep them where they could be destroyed at will by

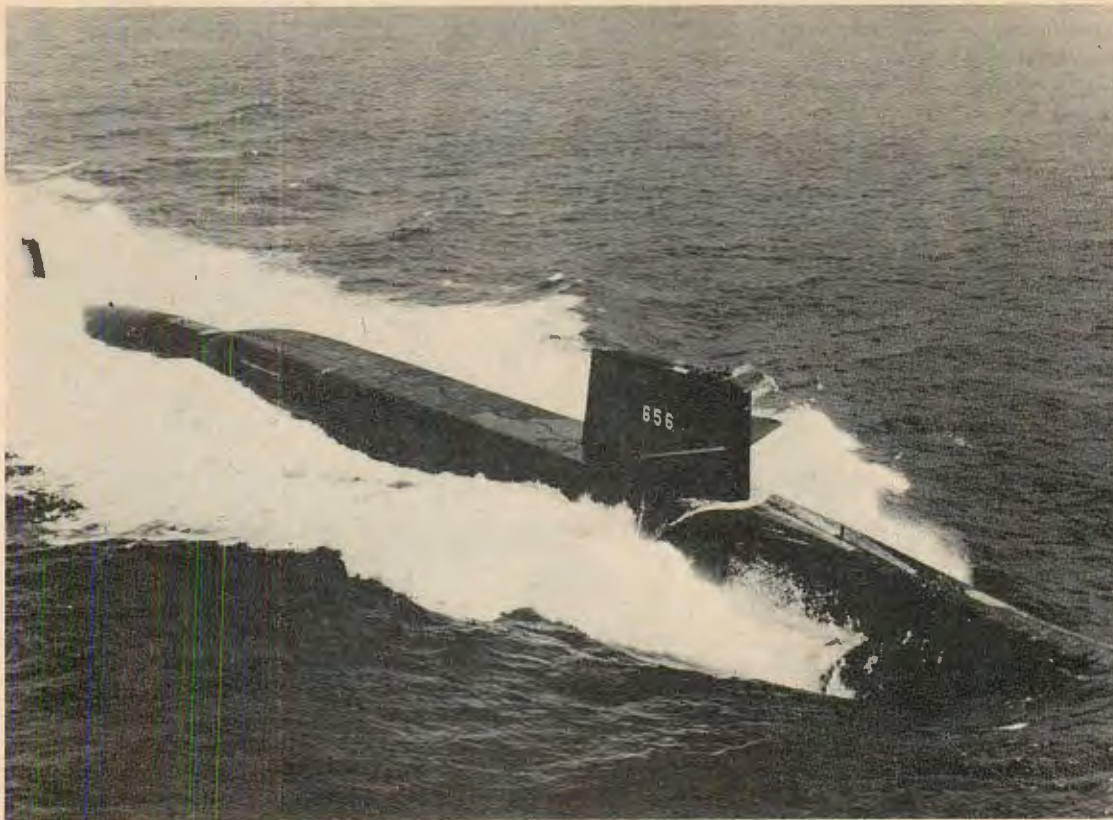

USS George Washington Carver (SSBN-656) nuclear sub at sea.

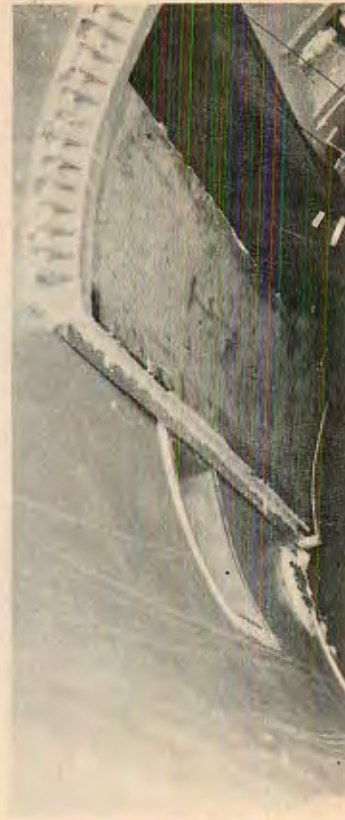

ICBMs, quite without killing Americans.

Reduced to some 2,500 40-kiloton warheads, what could the U.S. do? The USSR would still have about 7,000 warheads — all invulnerable. If the U.S. chose to strike back, it could not thereby reduce the threat to itself. At this point, the U.S. would have suffered militarily, but in no other way. The 3,000 Soviet megatons which would already have exploded over places such as Davis-Monthan Air Force Base, Ariz., and Warren Air Force Base, Wyo., would have killed less than a quarter-million Americans — five years' traffic fatalities. Nearly all of the casualties would have been military personnel or their dependents.

But if, at this point, an American president ordered a strike at Soviet cities, he would risk a Soviet attack on America's population. At this point, negotiated surrender would make far more sense. Moreover, even if the president of the U.S. or several submarine crews acting on their own were to launch Polaris-Poseidon on the Soviet Union, they could do relatively little damage. The Soviet civil defense system would have been on alert. The key industries would have shut down, "hardened" their machinery, and sheltered their workers. The rest of the urban population, the non-essentials, would have been placed in lesser shelters or sent to outlying areas.

Finally, the incoming American warheads would probably be met by some kind of antiballistic missile system. (It is doubtful the Soviets would initiate such an attack until their plans for missile defense were well along.) That fraction of the American warheads which arrived — probably far less than 100 — would knock down a lot of buildings. (T.K. Jones and Scott Thompson, "Central War and Civil Defense," *Orbis* [Fall, 1978].) The future would belong to the Soviet Union.

The Soviets will have completed their fourth-generation ICBM strike force by 1981.

This scenario could occur any time after 1981, when the Soviets will have completed deployment of their fourth-generation ICBM strike force. But because persons knowledgeable in military affairs know it could, the Soviet Union may not need to carry out an actual strike. In recent years American leaders have said loudly and often that military power no longer matters in world affairs. (Gen. Dan Graham, *Shall America Be Defeated?* [New Rochelle, New York: Arlington House, 1979].) They have been whistling in the dark.

More people's fates have been affected by military victories and defeats since 1960 than during World War II. During

these years India has beaten Pakistan twice, Israel has beaten Arab coalitions twice, North Vietnam, with Soviet help, has beaten the U.S., Soviet clients have triumphed in Cuba, Nicaragua, Algeria, Angola, Mozambique, Guinea, Ethiopia, Afghanistan, Iran, Laos, and Cambodia. They narrowly failed in Zaire and Indonesia.

Soviet clients or sympathizers have also waged inconclusive wars or have attempted *coups d'état* in nearly every country of Africa, Asia, and Latin America. The Soviet Union has repeatedly vowed support for such enterprises, and has made clear that their success depends on the growth of Soviet power.

Certainly the fear of greater Soviet involvement kept the United States from winning in Vietnam. That fear has helped to convince American policymakers not to help America's beleaguered friends in places like Iran. In 1973, the threat of Soviet intervention into the Middle East led the U.S. to stop Israel from consummating its victory against Soviet-supplied Arab armies which had attacked her on her highest holiday. The same prospect frightened the U.S. into submitting to virtual expropriation of its oil production equipment in the Middle East, and the quadrupling of the price of oil.

As the Soviet Union's arsenal becomes more fearsome, it will become more rea-



Business view of Boeing SM-80 Minuteman missile in silo.



A U.S. Poseidon missile leaves USS James Madison (SSBN-627) during shakedown.

sonable for the Soviet Union's friends around the world to be bolder, and it will be more reasonable for the United States and its friends to do more and to suffer more to avoid antagonizing the Soviets.

The incentives for friendship with the U.S. can only drop. Consider Europe, which is tied to the U.S. by bonds of kinship, culture, and interest. What would happen if, in 1982, the Soviet Union (or East Germany) quickly seized just a couple of squares miles of farmland on the German border on some transparent pretext? One thing is certain *not* to happen.

The U.S. would surely not launch nuclear strikes against Soviet cities. That would serve no rational purpose whatever. Would NATO then attack to take back those few square miles? Given that the Soviet Union can muster on the central front 21,000 tanks to NATO's 7,000, over 4,000 aircraft to NATO's approximately 2,000, as well as almost two soldiers for each of NATO's, a NATO attack would make no sense. Of course the Soviets would call for negotiations. No doubt NATO would attend.

What would Europe have to gain by taking an intransigent attitude toward the Soviet Union? Such an attitude would get Europe nothing but military trouble, which the U.S. could not alleviate. The U.S. could not help to defend Europe because the U.S. could not protect itself. American ground and air forces in Europe

could not stop a Soviet advance. But if American strategic weapons were used against Soviet forces in Europe, the Soviet Union could well afford to unleash a disarming strike upon the United States. Knowledge of this — not the small amount of force used to take the small border area — would quickly detach Europe from the United States.

American ground and air forces in Europe could not stop a Soviet advance.

This end could be accomplished quickly with even less direct expenditure of force. The Soviets could stage a *coup d'etat* or other military action against Saudi Arabia. The PLO would gladly lend itself to such a venture. Would America risk World War III (which American planners have made sure the U.S. will lose) for the sake of the Saudi royal family? But with Saudi Arabia — the world's largest exporter of oil — in anti-imperialists' hands, the Soviet Union would be in a position to approach Europe with the offer to facilitate their oil supplies at stable prices — if only Europe would slip out of its relationship with the United States. Given the balance of forces between the U.S. and the USSR in the early to mid-1980s, the Europeans would have to be heroes to

refuse the Soviets' offer.

The decisive defeat of the United States in the world — a defeat which would leave no doubt in anyone's mind who ruled the world — could be accomplished even more easily, given the "cover" of decisive nuclear superiority. On Oct. 1, 1979, the pro-Soviet government of Panama became legally sovereign over the whole Panama Canal Zone. Anytime thereafter it can abrogate the treaties which preserve a residual role for the U.S. Of course the U.S. would enjoy local military superiority. But, given the Soviets' ability to carry out a disarming nuclear strike on the U.S. and the latter's inability to disarm the Soviet Union, would the U.S. actually risk killing Russian soldiers? It would be more reasonable to absorb the loss of the Canal, and of the last shreds of American influence in the world.

Subjugation of the U.S. would open new and more violent chapters in world history.

Such losses could not help but jar the United States into realizing that strategic inferiority to the Soviet Union can only lead to enslavement. But surely, by the mid-1980s, this realization would come too late. Surely the U.S. would begin to build the weapons it should have built during the 1960s and 1970s. But how

would the U.S. respond to a Soviet declaration that the continuation of such an American build-up would be regarded as an act of war, for which the U.S. would bear full responsibility? If the U.S. chose to disregard the warning, the Soviets could look forward to losing their supremacy in a few years. Why should they not use it while they had it?

Subjugation of the United States would open new and more violent chapters in the history of the world. We can but speculate beyond the first one, the outlines of which are clear. The Soviet Union and its victorious coalition will still be hungry. Moreover, they are possessed of an ideology which tells them that the wealth of the formerly free world consists of goods somehow stolen from them. The rape of the United States would be swift.

Russians have never been very farsighted in the husbanding of golden geese. The history of postwar Eastern Europe indicates the Soviets would set unrealistic reparations quotas and try to squeeze blood from stones. They would attempt to rid the economy of "parasitic" occupations — and to rid the earth of "useless mouths." All would be made even harsher by the inevitable campaigns against religion, the family, and other ancestral enemies of communism.

Those given power would be the most reliable. Reliability would be proved by harshness. Unfortunately, this is not speculation, but dreary experience. The history of Soviet rule consists of little else.

The U.S. is not doomed to defeat. It possesses the technology to build better weapons than the Soviets.

The United States is not doomed to defeat. The Soviets have not built their nuclear forces by peculiar genius. The U.S. possesses technology to build weapons of the same kind that are even better. More important, the U.S. possesses the technology to build weapons of altogether different kinds, weapons which are likely to safeguard both our freedom and our lives. Of course to build these things at all we would have to change the way our officials have been thinking about war and weapons. Much would happen, however, if the American people transmitted one simple message to their officials: "We want to survive any war with our freedom intact."

With such a mandate, the next President of the United States would begin by ordering the U.S. Air Force to remove the Minuteman IIs and IIIs from their silos, to place them inside their factory canisters, and to keep them on the move aboard trucks, whence they could be launched. (See *Aviation Week and Space Technology* [19 June 1979].) This would remove the Soviet Union's ability to target

and destroy these missiles. With that gone, the Soviet Union would lose a large part of the military incentive for a first strike.

Second, the President would order the abolition of the system by which the U.S. has acquired weapons since 1963. Before 1963 it took about six years to translate an idea into a weapons system. Now it takes about 15 years. This system has reduced the U.S. armed forces to one of the worst-equipped forces in the world. If we proceed as we have been, the MX missile, our first counterforce weapon, won't be fully deployed until 1990. That will be years after the Soviets will have achieved a counterforce capability against the U.S. Unfortunately, 1990 is too late.

On a crash basis, the U.S. could have a mobile heavy missile on American roads by 1983.

With the WWII purchase system in effect, the U.S. could quickly build a mobile heavy missile, capable of taking out enemy silos. If we went about it on a crash basis, we could have the missile moving on American roads by 1983. Even more quickly, the U.S. could change the warheads on the Poseidon — reducing their number, and making them accurate weapon killers instead of terror bombs. A mere 1,200 big, accurate warheads aboard our submarines would do more to defend us than the 5,000+ little, inaccurate ones we now have.

We need new weapons.

Once these weapons were in hand, our targeting strategy could stop aiming at producing dead Russians, and could begin to concern itself with protecting Americans. With the weapons we have in 1979, even a massive change in American targeting doctrine could not hope to reduce the threat to the U.S. We simply need new weapons.

More important still, the U.S. could take advantage of new advances in the technology of anti-missile missiles and radars. These are especially efficient for defending mobile missiles deceptively based. The anti-missile need only shoot down the warheads which are actually heading for the right targets. A national network of interceptor missiles for the defense of our population is expensive, but possible. Just as possible but less expensive is a defense against ballistic missiles based on laser stations in space. (See Sen. Malcolm Wallop, "The Emerging Possibilities for Defense," *Strategic Review* [Fall, 1979].) This is not a Buck Rogers system. The technology for it is well known in the U.S. Lasers are not objects of speculation, as are particle beams. Megawatt-size lasers are weapons of today. With every passing

year, technology is making it even more possible for defensive forces to seize the advantage over offensive ones.

By 1982 at the latest, the U.S. will enter the most dangerous period in its history.

By 1982 at the latest, the U.S. will enter the most dangerous period in its history. In order to avoid the risk of disastrous defeat, the U.S. must begin to take action now, and surely cannot afford to put off certain crash programs beyond the first days of a new administration. These crash programs should: take our Minutemen out of their holes and fit them with counterforce warheads, fit Polaris-Poseidon with counterforce warheads, build a truly mobile MX (unhampered by Rube-Goldberg basing schemes), the B-1 bomber, anti-missile missiles, and space-based lasers. The country may not be able to complete these programs in time. But it can try.



**THE
SOLDIER OF FORTUNE
BINDER
ONLY \$7.95**

(INCLUDES POSTAGE & HANDLING)

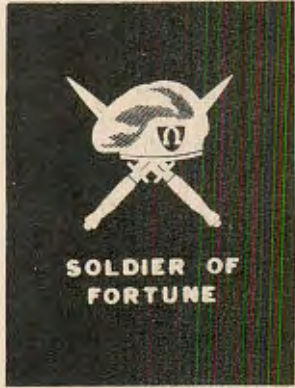

**SOLDIER OF
FORTUNE**

PRESERVE YOUR ISSUES OF SOLDIER OF FORTUNE IN THIS SPECIALLY DESIGNED, ATTRACTIVE BLACK WITH WHITE LOGO, SIX-ISSUE BINDER.

SEND CHECK OR MONEY ORDER TO:
SOLDIER OF FORTUNE BINDERS
P.O. BOX 693
BOULDER, COLORADO 80306

NAME (PRINT) _____

ADDRESS _____

CITY _____

STATE _____ ZIP _____

AMOUNT ENCLOSED \$ _____

PLEASE ALLOW 30 DAYS FOR DELIVERY

BULLETIN BOARD

Continued from page 21

ramifications and corporate security.

Assisting Monday are associate editors Robert Chapman, 27 years with the CIA in Latin America, Europe and the Middle East and most recently counter-terror consultant for police and security agencies in over 20 countries, and J. David Truby, author of *How Terrorists Kill: The Complete Terrorist Arsenal*, a member of the Washington-based Investigative Reporters and Editors, Inc. and a university level teacher of journalism and criminology.

WESTMORELAND OPPOSED TO COMBAT ROLE FOR WOMEN

Retired Gen. William Westmoreland warned Congress that morale will suffer if women are allowed to fight alongside men and said the issue is too important to be based on a simple social trend.

Westmoreland, who asked to testify as a private citizen, said no data existed on how women would perform physically or psychologically in combat: "We are taking a risk when we initiate a policy without any experience to back it up."

He predicted that battlefield morale would suffer if women were allowed in the field because, "No man with gumption wants a woman to fight his nation's battles."

"It [morale] suffers far more seriously when a soldier in combat does not have confidence in the capability of the person on his right and left."

Westmoreland is also opposed to the administration's plan to increase the number of women to 12 percent of the military forces by 1983.

Such issues, he said, should be weighed in terms of national security and "not on a basis of furthering a domestic political program or giving a boost to an alleged social trend."

ARMY RECRUITS "BELOW AVERAGE" ...

About 60 percent of Army enlistees are "below average in intelligence," according to Gen. Donn Stary, head of the Army Training and Doctrine Command. Stary said that problem was offset somewhat by "greater motivation" and that recruits of below average mentality are trainable, but that it takes longer to teach them.

Continued on page 86

PHOENIX



T-SHIRTS

\$6.95 each

ORDER TODAY! These T-shirts are 75% cotton, 25% polyester. Money back guarantee. Allow 3-4 weeks for delivery. Add \$1.00 for postage and handling. Dept. SF-2

AL MAR KNIVES

Handmade quality from 154 CM steel with a Rockwell of 57-59, the folders come with front lock and stainless bolsters and the fixed blades are full tang. The entire line comes with ivory micarta handles and leather sheath.

Clockwise

1. Fisher	\$ 70	7. Eagle	\$75
2. Road Runner	\$ 68	8. Falcon	\$43
3. Fang	\$ 80	9. Vulture	\$49
4. Pack Rat I	\$ 68	10. Bulldog I	\$60
5. Pack Rat II	\$ 68	11. Bulldog II	\$60
6. Buzzard	\$105	12. Hawk	\$37
		13. Osprey	\$35

Add \$1.50 each for postage and handling SF-23



NEW! MINI-14 MATCH PEEP SIGHT

Made of aerospace quality resin bond, this sight replaces standard sight, has hooded aperture, installs in seconds to improve accuracy with no modifications. \$4.95 Plus \$1.00 postage and handling. SF-25



VISA
Mastercharge

Overseas Orders add 20%
Colo. Residents add 3%

P.O. Box 693, SF777
Boulder, Colorado 80306



The Great Elephant Hassle in Vietnam

DUMBO DROP

by Jim Morris

IN December 1967, Captain Anthony Quesada, commander of the American Special Forces team at Camp Tra Bong, an isolated central Vietnamese mountain outpost, sent in what might be an odd supply request in a normal military outfit. For Special Forces it wasn't too unusual. The request was for two elephants. There was a real need for the elephants for the sole industry of the village of Tra Bong was a sawmill which had been installed by the combined efforts of Special Forces and the U.S. Agency for International Development.

The difficulty came because as the timber around the camp was cleared there was no means to haul wood from the outlying forest. The ground was simply too hilly for machinery. Elephants had been active in the area before and the village's citizens knew how to work them, but the war had driven all resident elephants into the jungle before Special Forces arrived.

"We'd be glad to move the elephants. Not to worry."

USAID was agreeable to furnishing money for the purchase of the elephants but was a little puzzled as to how they might be moved. The USAID official on the project called the Special Forces civic action supply section in Saigon. The lieutenant who answered the phone said, "We'd be glad to move the elephants. Not to worry."

The USAID man could never later recall the lieutenant's name. Once the full ramifications of moving the elephants came out, the kid never came forward to identify himself either.

Captain Scott Gantt, a tall skinny southern type with a dry manner, was project officer for the elephant move. His plan was to buy the elephants at Ban Me Thuot, where there were lots of them, move them by convoy overland to Nha Trang, a seaport, load them on an LST and move them to Da Nang. From Da Nang they would again go overland to Tra Bong.

This plan was immediately shot down when the group veterinarian informed him of the dietary habits of captive elephants.

"You'll need one LST for elephants and another for chow."

"Fifty pounds of high grade hay per day per ton of elephant, plus 50 gallons of water per day, per elephant. At three tons each for four elephants (two more had been ordered for Kham Duc) times nine days on the LST, that's about 6,000 pounds of hay plus 1,800 gallons of water. You'll need one LST for the elephants and another for the chow. Plus elephants get seasick. And the closest source of hay is Manila. I suggest we try for air movement," suggested Captain Tommy Dees of Edenton, NC, Group veterinarian.

While the purchase of elephants was nothing new for Special Forces, the attempt to air move them was. So Gantt called the Air Force. He was informed the only aircraft which could handle the move was a C-130. Since the strip at Tra Bong was too small to land the aircraft (Kham Duc had plenty of runway), they would have to land at Da Nang. However, in the meantime Gantt had determined that the road from Da Nang to Tra Bong was closed and there was no possibility of getting a convoy through without, at a minimum, getting a number of men killed by sniper fire. The cost was prohibitive. Another way would have to be found to move the elephants to Tra Bong.

There were other difficulties with the Air Force. They were glad to move the elephants, but had very stringent regulations about the air movement of large animals. The Air Force was leery of the possibility of having an elephant crashing around inside one of their airplanes in flight, making trim difficult. The requirement was that the elephants had to be unconscious and strapped down like cargo. In addition, a weapon big enough to kill an elephant had to be mounted inside the aircraft in case the beast woke up. The smallest weapon in the military inventory

capable of taking out an elephant quickly and simply was a .50 caliber machine gun, so one of these would have to be mounted inside the aircraft.

Staff Sergeant Richard Campbell had a valid suggestion as to how to get the elephants from the aircraft to Tra Bong. He suggested they be dropped in by parachute.

A quick call to the rigger section verified that it was feasible to drop something that size and weight. The rigger sergeant suggested that five 100-foot cargo chutes per elephant would do the job.

Dees, who is a parachutist as well as a vet, agreed the elephants could take the drop if they were strapped down on a cargo pallet and the pallet mounted on a stack of honeycomb shock absorbers, a common device used in airdropping heavy machinery.

Rumors of the upcoming elephant airdrop began floating around.

While all of this was in the planning stage, it became a sort of in-group joke and rumors of the upcoming airdrop started floating around Vietnam.

That was when I was called in as information officer. Gantt was getting inquiries from curious reporters who wanted to cover the upcoming event. Most military officers realize that news media people cannot do them personally any good, and may do them a great deal of harm, so he contacted me to help field any upcoming questions.

In the meantime, another hitch had arisen in the airdrop's planning. Dees had an animal tranquilizer in stock, which the Group had used occasionally to move animals as large as water buffalo. But by conservative estimate it would require 240 cc. of this stuff to knock out an elephant. These tranquilizers were administered by firing a hypodermic dart from an air rifle into the behind of the animal. The capacity of the darts is 10 cc. No one knew of any elephants sufficiently placid to stand still while 24 darts were shot into their

How do you move an elephant from point A to point B? Easy—all it takes is a plane, lots of tranquilizers, big parachutes, bunches of patience and a death-grip on your sanity.

posteriors. Another tranquilizer had to be found.

Waiting until one o'clock in the morning to get the time zones straight, Dees and Gantt started calling zoos in the United States over the Army's leased lines. Their first problem was to convince the Nha Trang operator they had to call the Bronx zoo at one o'clock in the morning to find out how to tranquilize an elephant. He wasn't supposed to take calls from drunks. Finally on the third try they convinced the operator they were serious.

"Do you have an elephant tranquilizer?"

Before the evening was over, they called five zoos. The information they wanted was finally obtained from the Director of the Cleveland zoo. An experimental drug called M-99, which had been tested in Africa, was a high-intensity morphine derivative and could knock out any elephant known in under 10 seconds.

Where could they get the drug?

It was, they were informed, manufactured by Ricketts and Sons, Leeds, England.

Gantt and Dees decided to wait until the next night to try to call England from Nha Trang.

I listened in. Damndest thing I ever heard. First the call had to be relayed through Saigon, then Honolulu, San Francisco, Washington, New York, Navarre, France, and a couple of others. The last voice we heard was the operator in Bristol, England, saying, "Wheah? Viet-Nayam?" We couldn't hear Leeds and had to relay through the Bristol operator. The upshot of it all was that Ricketts and Sons had the drug and it was everything claimed. All the 5th Special Forces had to do was procure a narcotics import license through the Walter Reed Army Medical Center and we were in business.

That took about six weeks.

In the meantime the press came. A claim on the story was more or less staked out by John McLennen of Reuters, and Curt Rolffes of UPI. McLennen is a South African, a big, easygoing guy who

looks almost exactly like Captain Marvel in the comic books, except his clothing is more prosaic. Normally he wears U.S. Army fatigues.

Rolffes is a tall, dark-haired fellow, a photographer who did a spell as a Peace Corps volunteer. He has one of the world's most spectacular beard-and-mustache combinations. The beard comes to two points below his chin. The mustache looks like rabbit-ears antennae, no less than seven inches on a side, waxed to needle points, quivering at the ends on an altitude more or less even with his eyeballs.

They wanted to know did we really plan to airdrop the elephants? McLennen had called Gantt on the phone and Gantt had given an answer that indicated we did.

We really did want to. Paratroopers are kind of funny anyway and we wanted to prove that it could be done. However, after McLennen's first story, some ominous rumbles had come from the British S.P.C.A. and it looked like we would get into an awful lot of flak if one of the chutes malfunctioned and we splattered elephant all over Tra Bong.

Alternate plan B had been developed. The Marines in I Corps were willing to provide a couple of choppers. We were going to sling-load the cargo pallets under the helicopters and take them from Chu Lai to Tra Bong that way.

McLennen and Rolffes were not highly pleased with alternate plan B since it was not nearly as spectacular a story. Still it wasn't bad.



Montagnard children play while their fathers ferry building materials.

He fired into the elephant's rump. It slumped to the ground and slept for four hours.

It was just as well the plan was changed. By the time the change had been announced, the British S.P.C.A. was picketing the American Embassy in London and stories like the following appeared in the British press:

A HEAVY PROTEST ON "ELEPHANT DROP" by London Express Service

LONDON, Jan 18 — Authoress Mabel Raymond-Hawkins deals with hundreds of animal problems at her 68-acre Sussex Animal Welfare Centre — "anything from hamsters to horses."

When she heard about the elephant drop into Vietnam, Mrs. Raymond-Hawkins, 65, stormed into the U.S. Embassy in London with a "jumbo" sized complaint.

"It's completely inhuman," the lady protested, "to parachute four 5-ton elephants in crates into thick Vietnam jungle."

Said Mrs. Raymond-Hawkins: "I'm not a woolly sentimentalist about animals. I can look a dead elephant in the face — but not a maimed one."

"Their poor pillar-like legs would take a terrible jar."

"This has nothing to do with my feelings about the war," she said. "A sense of justice is involved. Justice for elephants — and I'm on their side."

After a cable, a U.S. embassy spokesman explained the "jumbo-drop."

Two of the four elephants flown to Vietnam would be carried in nets slung underneath helicopters and landed at their thick jungle destinations. No parachuting was involved.

The elephants would help Vietnamese to rebuild villages destroyed by bombing.

While not totally accurate, the story was close enough. Parachuting was only one of the delivery techniques considered, but in our enthusiasm for it we had given McLennen the idea we had already decided on it. The only unfeasible thing about an airdrop was public controversy.

The irritating thing about this story was the statement that the elephants were to be used to rebuild bombed-out villages. There were no bombed villages in the Tra Bong area, and to me as information officer, the good thing about the story was its indication of the efforts the U.S. will put forth in its civic action program.

Civic action was absolutely crucial to our Vietnam effort, but it was one of the dullest stories in the world. As Murray Fromson of CBS once told me, "Even when our consciences get the better of us and we do a civic action story, nobody remembers having seen it."

Many people throughout the world, perhaps most of them, believed the U.S. was killing off thousands of innocent people every day and that Vietnam was an eroding wasteland. There is no question that there was massive social dislocation in Vietnam attributable to the war. Vietnam's culture was not viable in the 20th century and it was in the process of changing in a massive upheaval. The process was distinctly uncomfortable for the people involved. But as to the question of human life what was generally believed was untrue.

Greater efforts were made to avoid civilian casualties than were ever taken in any war before.

It was my hope that this elephant thing would give us just the tag we needed to get a really good civic action story across.

'Drugs for Operation Bah-room will be sent as soon as forms returned.'

On the same day the *London Express* story came out, Gantt received the following telegram from the State Department.

REQUESTED AMOUNTS OF TRANQUILIZER AND ANTIDOTE FOR ELEPHANTS ARE BEING HELD BY U.S. ARMY MEDICAL SUPPLY CONTROL BRANCH AT WALTER REED ARMY MEDICAL CENTER PENDING COMPLETION OF REQUIRED FORMS BY FIFTH SPECIAL FORCES VIETNAM REGARDING INTENDED USE OF DRUGS, AS REQUIRED BY BUREAU OF NARCOTICS. DRUGS FOR OPERATION BAH-ROOM WILL BE SENT AS SOON AS FORMS RETURNED. RUSK."

All we had to do was wait.

Scott Gantt, meantime, had been to Ban Me Thuot twice to arrange for purchase of the elephants. The procedure was quite a bit different from buying a used car. First he had to find a village of Mon-

tagnards who had elephants with which they were willing to part. It seems that over a period of years the elephants become part of the family and they cannot be sold except to family friends and only then after the seller is assured they will be well taken care of. It took Gantt several visits to establish this, and only then because he was in the company of Mike Benz of USAID who had that sort of relationship with the tribes.

Finally the arrangements were made, the elephants bought and paid for, although remaining in the custody of their original owners. The narcotics import license was received and the drugs were on the way. The project seemed assured of success.

Then came Tet.

Ban Me Thuot was hit badly during Tet and the elephants ran off during the battle. We had to have new elephants.

It took Gantt an additional two weeks to procure more elephants from Ban Don, another Montagnard village near Special Forces Camp, Trang Phuc. The narcotics arrived and I accompanied him to Ban Don to test the drug. He had to wear a gas mask while firing the air rifle. One of the earlier users of M-99 had inhaled fumes from the drug during testing in Africa and died instantly. It was powerful stuff. So, wearing the gas mask, Gantt fired the first dart into the elephant's rump. He stood back a safe distance and the dart hit crooked and broke off, failing to pierce the elephant's hide. He moved in closer and fired again. Ten seconds later the elephant was out on the ground. He slept like a baby for better than four hours, waking with no apparent ill effects. The stuff worked beautifully.

Tommy Dees had extended his tour in Vietnam twice to insure that the move went off properly. But his time in the Army ended and he was due to start graduate work in microbiology at the University of North Carolina. He went home. We were without a veterinarian. More waiting. Finally the new group vet, a big shambling captain named Stu McCahan, arrived.

He needed time to become acquainted with the problem before supervising the move. More time elapsed.

Finally everything was arranged. The drug was on hand. The vet was on hand. The elephants were on hand. The aircraft were scheduled for the move and the

“Noncombat moves during the emergency will make bad press.”

Marine helicopters were scheduled from Chu Lai to Tra Bong. Gantt went to Saigon to supervise things from that end and come back with the aircraft. I sent my assistant, First Lieutenant Frank Orians, with him to arrange for press coverage. It looked like it was going to be quite an extravaganza. Every major wire service and TV network wanted to cover the move. Most of the papers were covered as well as the news magazines.

“No noncombat flights when we’re on alert.”

The flight was cancelled. A nervous Air Force lieutenant colonel said it would look bad in the press if the aircraft were scheduled for a noncombat flight when the entire country was still on alert for Tet.

There was no other requirement for the aircraft during the time they were to be used to move the elephants. But this fellow was shaky about it and the flight was cancelled. He told Gantt that his flight had been cancelled “by the Ambassador.”

I do not know how Gantt managed it. It must have been difficult for a lowly captain. Conversely, an aroused Special Forces officer is hard to say no to. Thirty minutes later, Gantt was standing in front of Ambassador Bunker’s desk, demanding to know why “the Ambassador” had cancelled his aircraft to move his elephants of dubious ancestry and personal habits.

Mr. Bunker replied that he didn’t know anything about any elephants and since the U.S. has an abundance of ambassadors in Vietnam, why didn’t Gantt toddle over to Komer’s office and ask him about it.

As it turned out Ambassador Robert Komer, the boss of the American side of Revolutionary Development in Vietnam, had indeed cancelled the aircraft.

One of Komer’s assistants, another Air Force lieutenant colonel, was all for rescheduling the aircraft. He called the original Air Force lieutenant colonel at Ton Son Nhut Air Base and authorized it. But this man was so shaky he had to have the ambassador’s personal authority to reschedule them.

Komer was pretty busy at the time. His pacification program was in a shambles in

the wake of the Tet offensive and he was running around the country trying to patch it up. The Air Force lieutenant colonel in Komer’s office believed enough in the value of the elephants that he bearded Komer, who breezed through for a change of socks and some more papers before hopping on another airplane, and tried to get him to see Gantt.

“I haven’t got time to talk about */!/* elephants!”

Ambassador Komer was a man widely admired for many sterling qualities, but tact and patience were not prominent among them. His final comment as he flung out of the office was, “I haven’t got time to talk about */!/* elephants.”

Gantt, I am told, had to be forcibly restrained from killing him.

The long process of getting the elephants scheduled had to be started again. I left Orians to handle the story and went on up north to go into the A Shau Valley with Project Delta. This was an error, for when the elephant story finally did break I was in the 22d Surgical Hospital with a big hunk of my right arm shot off.

In any case, the Air Force was sort of embarrassed by their previous inability to cooperate and they were quite helpful about rescheduling aircraft. Once again it was all laid on. The aircraft were scheduled. The Marines helicopters were scheduled.

ABOUT THE AUTHOR

Jim Morris, a graduate of the University of Oklahoma’s professional writing curriculum, previously contributed “The Straphangers War,” an excerpt from his Paladin Press book, *War Story*, to *SOP*’s February 1979 issue. Morris, a three-tour veteran with the U.S. Army Special Forces in Vietnam, was awarded the Bronze Star with three oak leaf clusters, two for valor; the Purple Heart with three oak leaf clusters; the Vietnamese Cross of Gallantry, with Bronze Star; the Combat Infantryman’s Badge; and the Master Parachutist Badge for his military service. In 1969, he received a disability retirement from the Army in the grade of major. —Jim Graves

But the movement was cancelled again, this time by one Maj. Gen. McLaughlin, the head logistician in Vietnam. As usual, the reason was that it would look bad in the press if noncombat moves were made during the emergency.

However, the next day a story appeared over a Reuters credit line, giving the whole story of the elephants and the fact that the Army had cancelled the move because of fear of adverse publicity. The upshot of the story was that if the elephants were not delivered, the people of Tra Bong would have no means of livelihood and would have to return to the jungle under control of the Viet Cong, which was true. The story made McLaughlin look like an ass.

Who leaked the story to the press I don’t know. I would have been happy to, but I was in the hospital at Phu Bai. Gantt swears he didn’t do it. Would an American officer lie? About a thing like that? Hmmmmmm.

The move, entire and complete, was accomplished the next day.

“Bonny and Clyde” made a perfect news story.

No fewer than 28 members of the press were on hand. In fact extra aircraft were scheduled to move them. Represented were ABC-TV, AP, BBC, CBS-TV, GGTV (Japan), NBC-TV, *Newsweek*, Reuters, *Sydney Daily News*, *Time* and UPI.

Dubbed Bonny and Clyde by the reporters, the two elephants made a fine funny story, in a war that had little to be humorous about. It was one that couldn’t be better from the information officer’s viewpoint.

Apparently the Viet Cong had followed the story fairly closely too, because a large body of them were ambushed the next day moving toward the camp. Three were killed.

Dr. Martin Luther King was assassinated the day the elephants were moved and the news magazines were not printing any funny Vietnam stories that week. The impact of our good little story was negated by this much larger story with its tragic implications. Such is the life of a flack.





TOP: Bell P-63 "King Cobra" in WWII Russian markings. Almost all these planes were given Lend Lease to the Soviet Union or Free French. Only plane at Pima with communist insignia. **LEFT:** Consolidated B-24 Liberator bomber, "Pima Paisano," as it is today at Pima Air Museum. This was the plane flown from India and forced down over Pakistan. **ABOVE:** Boeing C-97 Cargo Master in Swiss markings. Used by Biafra Airlift during Nigerian Civil War by International Red Cross. Planes were flown by merc pilots. **BOTTOM LEFT:** B-29 "Superfortress," "Sentimental Journey," which had distinguished service record, flying some 30 missions over Japan during World War II.

BOMBER BONEYARD

SOF Staffer Visits Pima Air Museum

by Bob Poos

THE proud old B24 "Liberator" bomber plowed patiently through the thin air high above an invisible line marking the Indian-Pakistan border. It was on its last mission — a trip home — when the tranquil, routine activities of its crew were interrupted by the sight of jet fighters flashing by on either side.

The Pakistani Air Force jet jockeys wore puzzled expressions on their mahogany-colored faces because the old bomber bore different markings on either side — U.S. Air Force on the port and Indian Air Force on the starboard. Since India was an enemy of Pakistan, and America a friend, the fighter pilots were bemused. Finally one of them stabbed his forefinger groundward in the timeless gesture that airmen know means: "Get your ass on the ground or I'll put it there by gunfire."

Liberator pilot Lt. Col. LeRoy W. Svendsen obeyed immediately, following the fighters to a nearby Pakistani air base.

On the ground, he and the rest of the volunteer crew explained why they were flying this relic of World War II on March 28, 1969, and why it bore conflicting identification markings. Their story seemed unlikely and Pakistani authorities checked it thoroughly before permitting the plane to proceed onward.

The story which the Paks found difficult at first to believe was this:

The Liberator, one of the few operable ones left in the world, was on its way to something called the Pima Air Museum near Tucson, Ariz. It had been donated to the museum by the Indian government as a gesture of goodwill, hence the U.S. and Indian markings on either side. A volunteer U.S. Air Force crew was delivering the old plane from India, where it had been serving coastal patrol duty, to Arizona, more than 11,000 miles away by the route chosen.

Diplomatic wires between Karachi and Washington hummed for awhile before this unlikely tale was confirmed and then the crew was wished well and permitted to proceed on its way. Thirty days later, the

plane, now named the "Pima Paisano," touched down at Davis-Monthan Air Force Base near the Air Museum's location. Had it not been for the coolness and discipline of some Pakistani fighter pilots, the Pima Air Museum might have lost one of its most cherished acquisitions to the gunfire it had escaped in World War II — and an international incident could have occurred.

MASDIC AIRCRAFT

Actually, the story began back in 1966 when a bunch of Tucson area residents, some of them officers at Davis-Monthan and some influential citizens, including bankers, lawyers and a newspaper, decided that a terrible waste of historically significant aircraft was routinely occurring at the base — which is the Military Aircraft Storage and Disposition Center (or Masdic as it's called). All military aircraft, be they Army, Navy, Marine or Air Force, pass through it prior to being disposed of in one fashion or another — either sold outright or cannibalized for parts. And many irreplaceable aircraft, no longer suitable for military purposes but historically important, were being chopped up and rendered into ingots of aluminum, magnesium and copper every day. (Davis-Monthan is an operation of awesome proportions, consisting of more than 3,000 acres and containing at any given time upwards of 6,000 aircraft in various stages of repair or disrepair.)

The Tucson aerophiles decided that although other air museums already existed, most notably the Air and Space Museum of the Smithsonian Institute in Washington and the Air Force Museum at Wright-Patterson Air Force Base near Dayton, Ohio, Tucson would be an ideal location for another. In the first place, there were all those historically significant aircraft over at Masdic being melted down under the welder's torch that could be acquired — Air Force officials had hinted as much. Secondly, Tucson with its arid climate and extremely low soil-acidity level would present minimal problems of corrosion on planes stored outside. And it was

soon decided that this would be an open-air facility.

So this group of dreamers who first called themselves the Pima County (Ariz.) Air Museum Committee incorporated as the Tucson Air Museum Foundation of Pima County on July 18, 1967. They did not move precipitantly, but rather, spent years of planning. Members of the group contacted Pima County authorities and proposed establishing a public park with the museum as its focal point of interest. County officials agreed and they and Foundation members acquired 320 acres from the U.S. Bureau of Land Management (some 80 percent of the land in Arizona is owned by the U.S. government). The land was deeded to the county which designated it a public park with 30 acres initially allocated to the museum.

The Foundation began gathering aircraft from various sources, some donated by arranging transfer of title from branches of the services through Masdic and some being granted on a loan basis from the Air Force Museum and Smithsonian. For nine years these first acquisitions, including the Liberator, were kept at Davis-Monthan while the museum grounds were prepared and temporary buildings put up.

Then in 1976, 40 planes were moved from the air base across the road to the museum site and Pima Air Museum became a visible reality.

REPRESENTATIVE PLANES

One of the museum's board of directors, J.G. (Dutch) Snow, explains what the museum is all about: "Our concept is to preserve aviation history and to that end we try to have planes representative of an era or of a specific purpose. But we also try to find a plane that in itself has historical significance. Like Air Force One over there."

Snow gestures at what appears to be a virtually unused DC-6. "That's the first aircraft designated Air Force One, the president's own plane. It was Jack Kennedy's and they called it informally the

Continued on page 82

Achtung: TERRORISTS



West Germany's GSG 9: Armed and Ready

by S. Nielsen

SEPTEMBER 5, 1972: ski-masked terrorists lean over a balcony. Burnt out helicopters. Death and destruction.

The world went into mourning when terrorists killed 11 Israeli Olympic team members at the Munich Games. Television documented the attack on the Israelis from the Olympic village to their death at Munich's Fuerstenfeldbruck airport. The memorial service the next day brought a devastated, silent crowd of 80,000 into the huge Olympic stadium to hear West Germany's then-president, Gustav Heinemann, express his sorrow.

The Federal Republic of Germany had failed in its dedicated, expensive attempt to host its first Olympic Games since 1936.

Flimsy Security

In the excitement of the world event, West Germany had concentrated on keeping security low-key. Nearly everything was done to avoid comparisons with the National Socialist spectacle of '36. There were identity cards and other control measures, but well-wishers, reporters, tourists — and members of the Black September terrorist gang — came and went through the gates of the Olympic village. The terrorists put this on-the-spot information to good use. They had no trouble gaining access to the Israeli team's rooms, killing two Israelis upon breaking in. The international news media had a new focus.

Poor Coordination

The West Germans had no counter-terrorist plans drawn up for a terrorist attack. The lack of information and contingency plans is hard to believe in the light of more sophisticated terrorist operations since 1972. West German police did not run checks on known terrorists or monitor hostile aliens. Legalities stood in the way of quick action. Competent help never arrived on the scene in Munich because of jurisdictional rivalries among West Germany's 11 semiautonomous states, the constitutionally weak central government in Bonn, and the lack of decision-making procedures between state and city officials.

When word came that Israel was not going to release terrorist prisoners as demanded by the Black September group, the situation became more confused. Black September managed to get to the airport with the remaining nine Israelis.

In the meantime, in the dark, Munich policemen, waiting in ambush, were ill-equipped and unprepared. The odds were not in their favor — half-a-dozen snipers against eight terrorists. The police didn't even know how many terrorists they were dealing with until the last moment. When the snipers opened fire, half of them missed. They didn't have night vision devices. At that point, the terrorists realized they would never escape. The Israelis not killed

outright burned to death in the helicopter, where they were bound hand and foot, when the terrorists threw in a grenade.

Coming to Terms

The brutal scene at the airport forced West Germany to recognize that terrorism was alive and well on German soil and the government had no properly trained personnel to cope with the growing threat. But, how could West Germany create an elite "hit" squad without bringing up the specter of Otto Skorzeny's *Jagdverband*? One possible choice, for example, would have been the crack West German Alpinist group, which obviously had military as well as rescue training.

After much deliberation, it was decided to create a new group for the explicit purpose of combating terrorists, rather than up-grade, redefine or retrain an existing unit.

Still, the new group would have to be attached to some existing organization. The West Germans were reluctant to open themselves up to criticism that they were recreating the SS. One way to avoid this was to make the new group nominally non-military. It became part of the police force, the Federal Border Patrol (*Bundesgrenzschutz*). There were eight existing units, so the new elite squad became number 9 — *Grenzschutzgruppe 9* — or GSG 9 for short. It is under the Federal Ministry of the Interior.

A New Creation

West Germany's border guards dress in comfortable, almost baggy, green wool uniforms. They look more like local forest rangers than the superbly trained commandos they are. There is little traditional military formality. The men mingle easily. They have to — their lives depend on it. Even during training, no one pulls rank. It is difficult to distinguish instructors from pupils.

This informally structured unit is equipped from one of the most complete, varied, sophisticated — and expensive — depots in the world. GSG 9's budget now runs more than \$1 million a year. Most of this goes for outfitting and training, certainly not for salaries. The men are considered policemen and paid accordingly.

Equipment

GSG 9 has an array of weapons, vehicles, electronic gadgets and communication systems that make it the envy of other strike forces. Some elite groups concentrate on using one weapon, rationalizing that complete familiarity with one weapon will give optimal results. Not so the GSG 9, which trains its men with Heckler & Koch's G3SG/1 weapons system. (See page 39.) International terrorists have not limited themselves to one type of

weapon for uniformity's sake — neither has GSG 9.

The same teutonic thoroughness has been applied to the transportation pool. Superbly appointed, luxurious Mercedes 280 SE sedans have been specially modified for high speed stability, bullet-proofed, and armed, as have customized French helicopters. Tactical helicopter insertion is a crucial aspect of GSG 9 training. Naturally, the range of vehicles includes more modest types that do not attract attention.

Only the best make it.

Equipment plus training make the men of GSG 9 an elite corps. Only the best make it. About 80 percent wash out during the 22-week training period. The men join from the ranks of the police force: they cannot enlist directly.

The training's basic thrust is two-fold: minds and bodies. Not one aspect of psychological or physical preparedness is left out. The emphasis is on acting, not reacting. As the commander since the beginning, Ulrich Wegener, understates it: "Our specialized organization is, without exception, oriented towards the opponent." Thus, training is made as difficult as possible. The instructors have no illusions about the opposition's militancy.

GSG 9 places more importance on academic training than most other anti-terrorist groups. A typical day lasts 14 hours or more and much of that time is spent poring over text books. As one Israeli anti-terrorist expert put it, "They eat and sleep terrorism."

The first 13 weeks of training cover the basics: karate instruction, police versatility, jurisprudence, weapons familiarization and marksmanship. Karate training is given special attention, six hours a week — good evidence of the GSG 9 slogan that shooting is a last resort.

Candidates are trained individually as well as in groups. Exercises are aimed at building self-confidence and testing it. Training often takes place "on location" in rural, mountainous or high-altitude country. Fitness training culminates in an intensive historical and psychological look at the roots of terrorism. Special emphasis is placed on developing the ability to anticipate terrorist tactics and moves by analyzing the physical and emotional environment in which the terrorist is operating.

The concluding nine weeks of intensive work go into the more exotic aspects of terrorist confrontation. The men are brought up to date on the latest discoveries in the anti-terrorist market place, new developments in the optics and communication industries, and intelligence reports on terrorist activities. They become acquainted with the sharp-shooter's specialized tools: night vision devices, high-quality observation glasses, etc.

Evasive driving techniques are an important part of the agenda. Learning to manipulate the wheel of a heavy-duty Mercedes at 90 miles an hour is quite an experience. The sedans come equipped with enough electrical gadgets, inside and outside communication systems, two- and four-meter-band radios, to make one feel at home in a 707 cockpit.

Weapons

Intense familiarization with the complexities of GSG 9's weapons makes handling routine. Everyday, standard equipment includes the H&K MP 9mm submachine gun. This weapon is considered the service arm of the German police force. It fires from a closed bolt, but is extremely accurate in single fire up to 100 meters. The MP 5 is recoil-operated with stationary barrel. It lies comfortably in the hand. The roller-actuated bolt gives absolute security when the weapon is handled or shot. Cartridges are fed through a 30-round magazine. It is usually operated with an H&K silencer. In fact, noiseless weapons are used exclusively against terrorists.

For sniper missions, the H&K G3SG 1 is used. It can be equipped with a grenade launcher. The real showpiece of the GSG 9 is the Mauser 66. Small arms consist of the P9S 9mm H&K pistol and the Smith & Wesson .38 Special revolver.

The men learn to handle these weapons, and themselves, on a modern \$9 million underground combat installation. The entire training headquarters is set in St. Augustine in the Rhine valley hills near the federal capital, Bonn. The provincial setting belies GSG 9 fame. More than 50 countries have visited headquarters or had the German experts come to them. Most prominent is Israel's counter-terrorist group, the 269 Headquarters Reconnaissance Regiment.

Mogadishu

GSG 9 existed for five years before its first major test. A Lufthansa 707 was hijacked with almost 100 people on board. Their ransom: the freeing of members of the Baader-Meinhof gang imprisoned in West Germany. After several stops in the Middle East, the plane finally came to rest at the Mogadishu, Somalia, airport on 17 October 1977. The West German Ministry of the Interior, on the alert, sent off members of GSG 9. Only 27 of its 180 men participated in the assault that lasted only six minutes. The Mogadishu success remains a model for anti-terrorist action.

After a go-ahead from Bonn, the men landed in a blackened plane and immediately met for a briefing session with their colleagues, the Somalis, members of Britain's Special Air Services (SAS), and Israelis from the 269.

Somalis surrounded and secured the airport. The British were responsible for



The men and their arms. They are also familiar with terrorist weapons. Training includes close encounters with the well-known AK-47 and esoteric, terrorist-made articles of defense. Photo: German Press Office.

planting eavesdropping equipment and supplying stun-grenades. Israelis assisted in coordination and intelligence work.

It took only two hours for deplaning, unpacking weapons, mounting and adjusting grenade launchers and infrared night-sighting devices, putting on special clothing and armored vests. The operation began with the departure of reconnaissance and sniper teams. Ninety minutes later, the coded signal was given.

The Somali armed forces lit a fire about 100 meters from the hijacked plane as a diversionary tactic. When the terrorists moved into the cockpit to observe,

rubber-coated ladders were placed against the four emergency exits.

“Fireworks!”

Shortly after midnight the codeword, “fireworks,” was given and Commander Wegener and his men penetrated the plane. The stun-grenades exploded in a fury of light, sound and shock waves. About the size of a beer can, these grenades basically disintegrate with no fragmentation, but put out 50,000 watts of candle power. Two terrorists in the cockpit resisted and were shot.

The operation was over: “We have control of the airplane!” From start to finish: six minutes.

Three hours later, the GSG 9 was on its way home to a heroes’ welcome. Many Germans were unaware of the spectacular rescue because everything had happened so fast. The men debarked from the airplane at Cologne in dungarees and sports shirts.

The GSG 9 comment on the smoothness of the operation? A growling, “Well, we trained long enough.” The crucial shootout had lasted less than a minute.

After Mogadishu, plans were developed to increase the GSG 9 from 180 men to over 300. Recruitment proved difficult, however, and the number of men has decreased to 160. Other than the glamor, there are few inticements to join. The men pay their own insurance. Soldiers who want to join the GSG 9 have to become policemen first. An additional frustration has resulted from the unit’s being forced to stand by while local policemen attend to West Germany’s urban guerrillas. Attempts are now being made to allow GSG 9 to be called in by local police and even help trace and track down terrorists.

West Germany, situated between east and west, remains fertile ground for terrorists. Experts know that the “Terrorist Internationale” definitely has access to nuclear weapons. With this fearsome capability in mind, GSG 9 will continue to be an essential part of West Germany’s anti-terrorist force.



Helicopter insertion is a major part of GSG 9 training. One-to-one instruction, here obvious, teaches self-reliance. Photo: German Press Office.



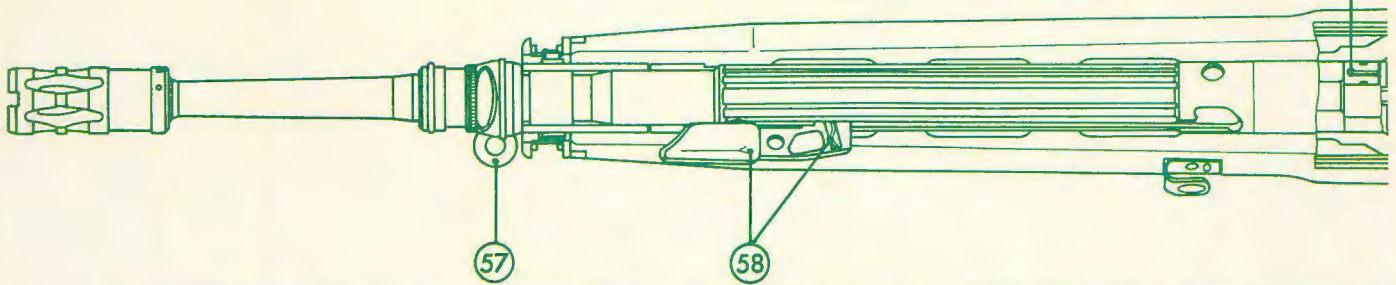

GSG 9's Guns

by Chuck Taylor

THE stunning Mogadishu raid, brilliantly executed by the men of GSG 9, stands as a contemporary milestone. In this age of mediocrity, a truly smashing feat of collective and individual expertise and bravery is rare indeed, and those who participated deserve all our respect. They have the spirit of the old Army Rangers, and the Special Forces men at the beginning, as well as the British Commandos, the SAS, Selous Scouts, and USAF combat control teams. They are honest-to-god men!

Such men are unique and so are their weapons. In the case of GSG 9, the Heckler & Koch "system" is the choice, and a good one it is.

Heckler & Koch hails from Oberndorf, Germany, and still has a large manufacturing facility there. But they also have 13 other plants around the world, including one in Iran, which causes considerable consternation to H&K officials, considering recent events in that embattled country. H&K is what Fabrique Nationale was a decade ago, and it is no surprise, at least to me, to see that the ubiquitous 7.62mm G-3 rifle has replaced the venerable FN-FAL as the most prolific battle rifle in the non-communist world.

The G-3 is only the tip of the iceberg, for, based on the initial G-3 concept, H&K has built the damndest system of weapons I have ever seen. The really interesting — if not astonishing — thing, however, is that the system really does work — and works particularly well.

The idea of a weapons "system" featuring a number of weapons based on a single action is not new. We all remember the infamous Stoner, which was neither reliable, powerful nor particularly useful. We also remember the Colt AR-15 system, with a survival weapon, a "SMG," a heavy-barreled auto-rifle, a standard battle rifle, and even a belt-fed GPMG. It, too, wasn't particularly satisfactory. The



MP5K, H&K's latest version of the MP5 series, is a natural for secret service or executive protection missions. Note lack of stock.

big difference between these and the Heckler & Koch system is that the H&K system works.

The basic idea came, in this case, from the last designs of the Nazi arms industry, circa 1945, with the little-known StG-45 assault rifle in 7.92mm Kurz. The war was in its last days and this weapon was produced only in small quantities and, as a result, saw limited action. But, be this as it may, the adaptation of the Stecke lock (MG-45 GPMG-delayed roller locking, blowback action) worked, and the men who participated in the project realized that the design's possibilities were virtually limitless in application.

The first post-war organization to pick up the pieces and continue work on the evolution of the design was "Centro de Estudios Tecnicos de Materiales Especiales," known as CETME to the rest of the world. Under the CETME banner, both Spanish and German arms engineers, some of whom had worked on the original StG-45 design, continued their research and development, which culminated in the late 1950s with the CETME M-58, the weapon on which the superb H&K G-3 is an improvement.

The concept of the roller-locking system allows the use of virtually all present-day cartridges, from pistol, through intermediate (assault rifle), through full-caliber battle rifle, even up to and including the venerable cal. .50 BMG. As I said before, it really does work. Obviously, such versatility allows any number of weapons to be created, which is precisely what H&K has done.

Of particular interest to me is the fact that an almost mind-boggling amount of thought and experimentation has gone into what we now call the H&K "system." Depending upon which specific weapon we analyze, we find that from 47 to 70 percent of the parts are interchangeable, even between radically different weapons such as rifles and SMGs. The beauty of this is not only that the logistician and military planner, not to mention the poor guy who is pulling out his hair over budgets, is kept happy, but the soldier on the battlefield can use any of the weapons in the system effectively once he has been introduced to the basic functioning concept of only one weapon in the system.

The value of such an idea is so glaringly obvious and attractive that one wonders

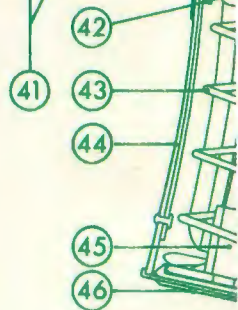
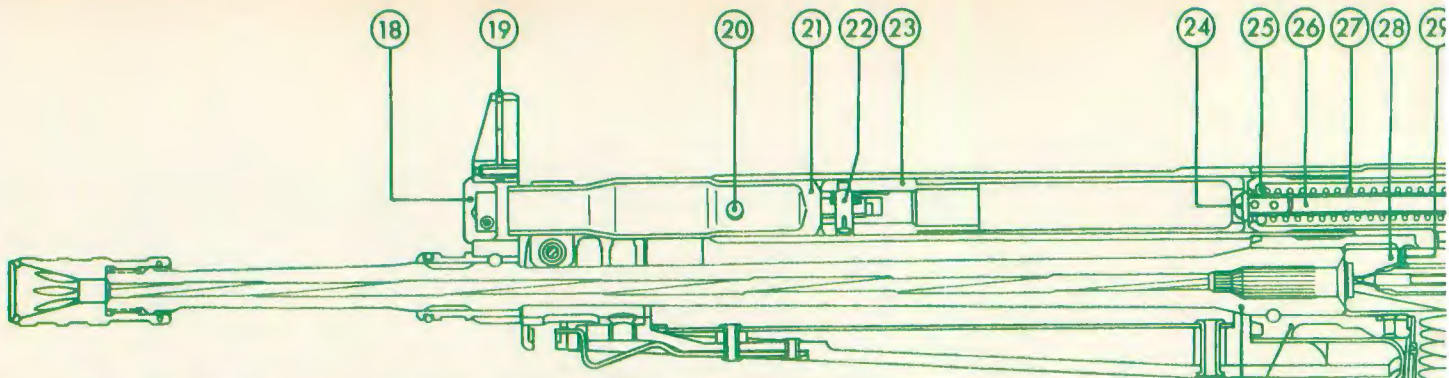

Taylor found MP5K, a chopped and channelled version of the MP5 in 9mm Kurz — .380 caliber, light, small and controllable.

TOP: Dual magazine release — Innotative feature of all H&K shoulder arms. Has both tab and button release magazine, excellent military weapon feature. BOTTOM: Sniper trigger group for G-3 SG-1 and HK-33 SG-1. Tab behind trigger activates set trigger for precision accuracy. When not activated, trigger functions in normal mode.

why in hell no one has been able to make it work before — now H&K has, so they get the credit.

In reality, there are actually a number of H&K “systems” — consisting of “groups” of weapons particularly well-suited for various needs. For example, “Group 1” of the H&K “system” consists of the following:

1. G-3A3 and G-3A4 cal. 7.62x51mm NATO rifle.
2. HK-21A1 cal. 7.62x51mm NATO GPMG.
3. HK11A1 cal. 7.62x51mm NATO LMG.
4. MP5A2 and MP5A3 cal. 9x19mm parabellum SMG.

Here we have the closest thing to an ideal weapon-system for the average NATO country — only two calibers, 7.62x51mm NATO (.308 WCF) and 9mm parabellum (Luger), for minimal logistic headaches as far as ammunition is concerned, and for parts and accessories departments.

Group 2 consists of:

1. HK33A2 and HK33A3 cal. 5.56mm (.223) rifle.
2. HK33A1 automatic carbine cal. 5.56mm.
3. HK53 “SMG” cal. 5.56mm.
4. HK21A1 GPMG cal. 5.56mm.
5. HK13 LMG cal. 5.56mm.

This covers all of the countries that prefer the 5.56mm, and since many are dependent on the U.S.A., which uses the 5.56mm as its standard service cartridge, the number is considerable.

Group 3 is:

1. HK32A2 and HK33A3 cal. 7.62x39mm rifle.
2. HK32A1 automatic carbine cal. 7.62x39mm.
3. HK21A1 CPMG cal. 7.62x39mm.
4. HK12 LMG cal. 7.62x39mm.

Here we have a system for countries with considerable supplies of, or access to, the current Soviet bloc service cartridge. An excellent idea for nations such as Finland or Turkey, not to mention

Zimbabwe-Rhodesia, South Africa and Israel.

Group 4 is a “system” of submachine guns consisting of the entire H&K SMG line:

1. MP5A2 cal. 9x19mm parabellum (Luger).
2. MP5A3 cal. 9mm parabellum (retractable stock).
3. MP5SD1 (no buttstock at all w/ sound-suppressor).
4. MP5SD2 (fixed buttstock w/sound-suppressor).
5. MP5SD2 (retractable buttstock w/ sound-suppressor).
6. MP5K (Kurz: Short) (Mini version of MP5 with no buttstock capable of being carried concealed easily. Nearly perfect for “secret-service” type use).

Group 5 is a “Special Purpose” system:

1. HK69A1, cal. 40mm Grenade Launcher.
2. MP5SD2 and MP5SD3 cal. 9mmP silenced SMG.

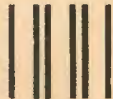

BUSINESS REPLY MAIL

FIRST CLASS PERMIT NO. 1173 BOULDER, COLORADO 80302

POSTAGE WILL BE PAID BY ADDRESSEE

SOLDIER OF FORTUNE
THE JOURNAL OF PROFESSIONAL ADVENTURERS
P.O. BOX 693
BOULDER
COLORADO 80306

NO POSTAGE
NECESSARY
IF MAILED
IN THE
UNITED STATES

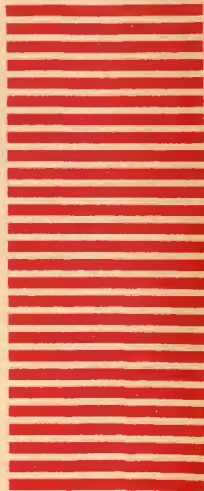

Can't find SOF at a convenient newsstand? Perhaps SOF has sold out. Or your local dealer doesn't have the guts to carry it. You can solve this problem by subscribing now to SOF.

HAVE YOUR OWN COPY OF SOLDIER OF FORTUNE!

Don't depend on someone else to get you the magazine of professional adventurers. Don't wait to receive the latest news on mercenaries, automatic weapons, combat pistolcraft, knives and knife-fighting, self-defense and clandestine operations.

SUBSCRIBE NOW!

YES! I want to join the Professionals and find out where the action is.

ADDED POSTAGE:

\$14.00—Domestic 1st Class

\$24.00 Air—Europe

Latin America

\$ 6.00 Air—Canada, Mexico

\$30.00 Air—Other Countries

Add \$ 5.00—for all Foreign surface mail except Canada & Mexico.

Send me 12 issues (full year) of SOF for the low subscription price of \$20 — I save \$7.00 over newstand. (Newstand price of SOF is now \$2.25 per issue.)

PAYMENT ENCLOSED

BILL ME (Not valid for foreign subscriptions.)

SOF 29

NAME (PRINT)

ADDRESS

CITY

STATE

ZIP

HECKLER & KOCH GMBH

OBERNDORF/NECKAR

33 cal. 5.56 mm x 45 (.223)

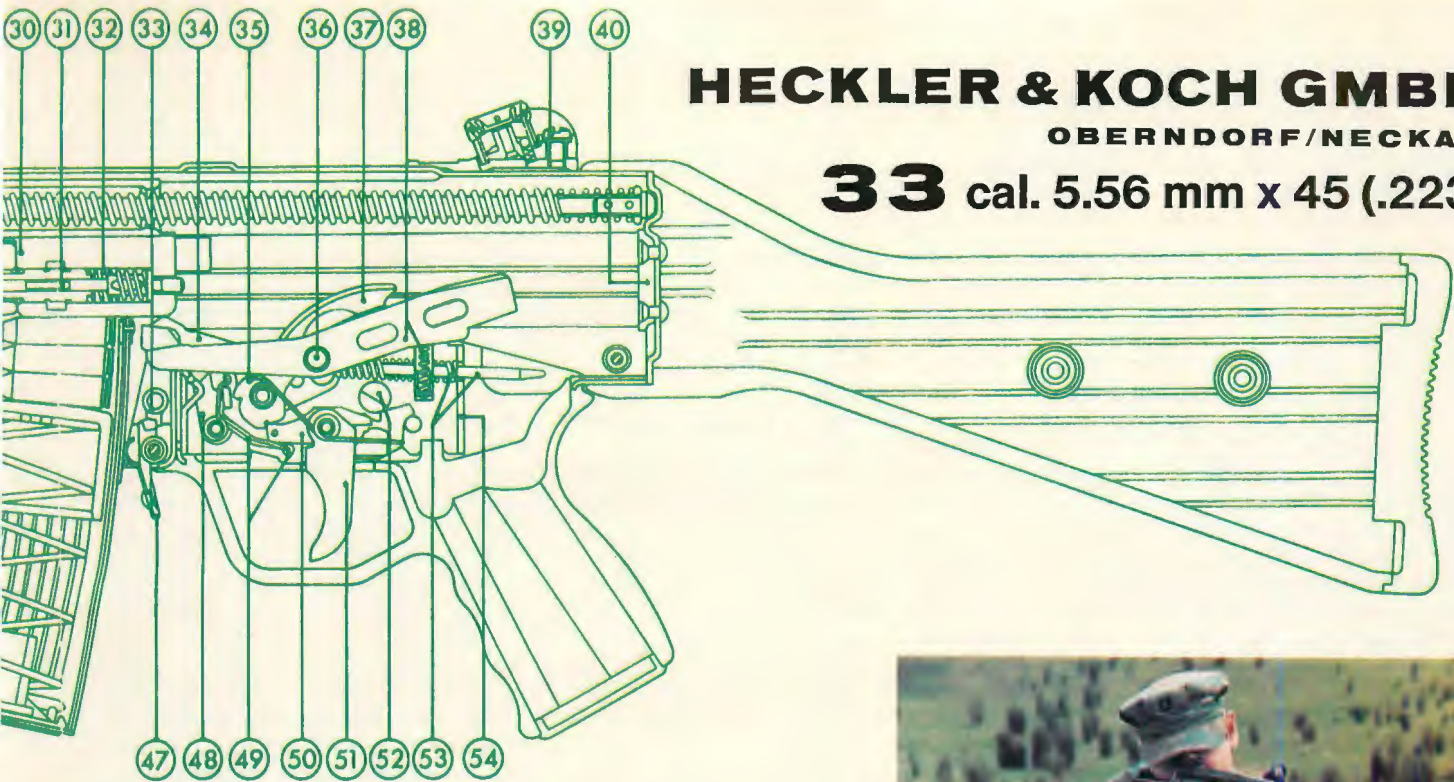

MP5 SD A3 submachine gun features telescoping stock and suppressor. Vent holes bleed off gas right out of chamber which prevents 9mmP bullet from exceeding supersonic velocities, thus eliminating muzzle blast and sonic "crack."



Taylor prepares to fire MP-5 SD A3, his favorite weapon in H&K inventory. Sound compares to that of pellet gun. Weapon is accurate, rugged, reliable. Author's only complaint is it is not offered in .45 ACP.

3. G3 SG/1 cal. 7.62x51mm NATO sniper rifle.

4. HK33 SG/1 cal 5.56x45mm (.223) sniper rifle.

Group 4 (SMGs) is offered to potential commando units, etc., and Group 5 is aimed at SWAT teams, raiding units and other teams with a special-purpose function.

It should be obvious by now that H&K understands how to have "something for everyone," giving ample evidence that they not only have what may well be the best and most viable weapon-system in the entire world, but they also have the most aggressive, well-designed sales and marketing techniques in the world.

To quote from the Heckler & Koch data sheet:

"The basis and prerequisite for the HK weapons system was the bolt and operating principle of the G-3 automatic rifle, a recoil-operated rifle with delayed roller-locked bolt system."

MARCH/80

The data sheet also states the HK weapons system satisfies the requirements of the logistician, military tactician, cost analyst, and production man. It includes all postwar developments introduced in the field of ammunition for infantry small arms match. Each weapon's weight and size are individually matched to the caliber required for its tactical employment.

In the system's development, the planning called for each weapon model to be provided with that receiver corresponding precisely to its caliber, function and proposed tactical employment in order to eliminate the need for connections, attachments or alterations to the respective receiver, which would be necessary with an over- or underdimensioned receiver.

The data sheet continues, "The overall concept of the G-3 rifle, which has been in military use for many years and which still continues to be produced in large quantities, the utilization of all practicable new developments in the field of weapons

technology, improved materials and the employment of the most advanced machine tools and special equipment insure that the soldier has at his disposal a weapon of sophisticated design and technology."

Shooter safety, reliability even under punishing conditions, accuracy, simple handling and easy care maintenance were H&K's goals — goals which they achieved. Advantages of the system for the logistician and tactician include:

1. Economical production — Large scale utilization of sheetmetal stamping, pressing and cold-forming technology.
2. Simple training and handling — Once familiarized with one weapon, the shooter can handle all other weapons.
3. Versatile tactical employment — The most effective weapon for every tactical purpose.
4. System related — Its great advantage

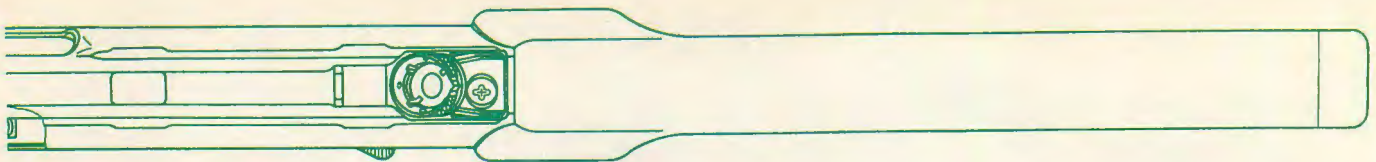

is ability to use that caliber best suited for each situation.

5. Easy care and maintenance.
6. Effortless supply and storage — Extensive interchangeability of parts and assemblies, reducing inventories to a minimum in the depot and among the troops.

The data sheet concludes, "These principle features of the HK weapons system apply — apart from the HK69 — also to the other HK special purpose weapons."

My observation is that H&K is the best organized and operated outfit of its type in the world. Their weapons are most impressive and will do everything they say they will do. As opposed to almost every other organization making grandiose claims, H&K has the capability to, desire to, and, in fact, does, deliver exactly what they promise.

H&K weapons sell themselves. I am known for being a cynic and "axe man" in the field, and most arms companies shiver in horror when they learn I am evaluating their weapon(s). The Heckler & Koch people advised me that they welcomed my evaluations of their products and invited me to their facility to test them.

I was provided a tech man, who introduced me to the full spectrum of weapons and served as my guide and magazine loader (yech!) in the tests. I received no high-pressure sales talk, nor was I provided with hot/cold running ladies to keep my mind occupied on matters other than weapons. What I did get was an intelligent answer to every question I asked, and everything in their inventory at my disposal.

My evaluation? Christ, the stuff is impressive.

I shot a 1.125-inch group at 300 meters with the G-3 out of the box! And with military ball ammunition, not match grade. That computes to .375 MOA, gents, and that's completely off the scale, isn't it? A military rifle that shoots like a benchrest gun, and it's rugged, reliable, powerful, and handy. What more can one ask? Even though I had never picked up one of their weapons before (other than firing the standard G-3 service rifle at Ft. Benning a decade ago), I was able to hit everything I shot at almost every time. H&K weapons' ease of shooting is perhaps their greatest asset, even greater than the system's other advantages.

Within three shots, with the G-3 SG/1, I picked off pebbles at 75 meters, off-hand, every time. With the PSP 9mm pistol, HK-4 in .380, and P9S in .45 and 9mmP I placed hits on targets way out past normal handgun ranges. With the

MP5s I destroyed everything I shot at, even from the hip, at ranges past what should be considered SMG range. Was I impressed? You bet I was! I can well see why GSG 9 chose Heckler & Koch weapons for their men.

It is embarrassing to me that a firm based in a country other than my own produces better general-purpose small arms than my own country. Those who know me will tell you I have always insisted the best weapons in the world have come from the United States. I can no longer make that statement. The G-3 I shot, picked at random from inventory, made my match-grade M14 look like a Brown Bess musket — and it shoots MOA accuracy! That is truly embarrassing to a guy like me.

No, I'm not suggesting everyone trade in their M14s and M1As for G3s or HK91s, but I am saying that the H&K line of arms is now, in my opinion, the best of its type in the world and I would have no qualms whatsoever about going into a fight with any of their weapons. I certainly cannot say this about current U.S. military inventory weaponry.



Heckler & Koch 53

A number of things bothered me about several H&K weapons prior to my visit. The G3/HK91 series, in particular, possesses a very hard, and I mean hard, trigger, at times detrimental to accurate shooting. When I brought this matter up with H&K officials, I was advised that NATO required a rifle capable of being mishandled, dropped, thrown, etc., with a live round in the chamber, the safety off, and not discharging — ever. They say this trigger is the answer to that requirement. The gun I have been testing rather hard for the last three months now has not discharged, despite my efforts, and the trigger can be smoothed up with little problem.

Another complaint was the ejection of empties into "a galaxy far, far way," much to the handloader's chagrin. Admittedly, the G3 series isn't intended primarily for the handloader. H&K's explanation was that NATO policy prefers not to have empties piling up around one's foxhole,

thereby possibly giving away his position.

The fluted chamber does not ruin brass as many — including me — previously thought, and the dent amidst fireforms out the next time the case is fired. Since the dent is in a different place each time, no big deal. And, since primary extraction of the spent case does not involve a "twist" as do most of the rest of the world's fighting rifles, there is no stretching in the cartridge case web, which as we all know, eventually causes head separation and subsequent brass discarding. Like the old Ford commercial said, "I didn't know that."

The rear sight was of particular concern to me, since I couldn't understand it. I now know it is adjustable for elevation as well as windage in spite of its rather sit-there-and-look-at-you appearance. But it requires a special tool. As for the 100-meter "V-notch" I was told that it doubles as a night (poor light) sight.

The handgun bellringer in the H&K line is the new PSP 9mm pistol which features a squeeze-cocking device built into the gripframe of the gun. Normal grip pressure cocks the gun and if the pressure is released, the gun won't fire because it automatically uncocks itself. The test gun's trigger was a dream and the accuracy superb, as was the workmanship. In a big caliber the PSP could be the answer to the U.S. police sidearm problem. Imagine a 40-plus caliber PSP in a police officer's holster to solve the old public relations problem of "cocked-and-locked" .45 autos. And the PSP is a good, solid, reliable service gun, not a double-action, junker-nightmare.

The VP70 machine pistol is a good choice for those who require a defensive weapon in the military sense. Company grade officers, NCOs, machine gunners, grenadiers, and medics could defend themselves easily and effectively with the VP70 — thanks to its three-shot-burst-only feature — even with little training. Because the military does not teach its troops to use pistols, the VP70 may well be the answer to the problem and I look for it to be seen more and more frequently in the future.

The men of GSG 9 are unique in their expertise, esprit de corps, and performance, who deserve the best weaponry available. It is not difficult to see why they chose Heckler & Koch's system as their own. Like the man says, "You can't beat the system."



GSG 9: The Philosophy

by Jeff Cooper

TERRORISM may be defined as the indiscriminate employment of fear, principally against the innocent and uninvolved, in the pursuit of a debatable political point. It is by no means unique to our times, but it has suddenly become a matter of general civil cowardice. Without firearms and explosives it is difficult to carry out, but without submission it is impossible.

Plain banditry is certainly wicked, and is dealt with harshly by sensible people, but it is relieved by a certain straightforward honesty.

"I want what you have, so give it to me or I will kill you!" says the robber. This is evil, but we can meet it fairly.

However, to say, "You must do what I want or I will kill this defenseless other person," is to announce that you have no decency, and that you count upon the decency of others to effect their undoing. This is to pervert and corrupt the very essence of righteousness, and is thus insufferable. In obscene parody it is at once horrible and ridiculous. Unless it is mercilessly stamped out, just as piracy on the high seas was mercilessly stamped out, civilization will become both unworkable and dishonorable.

GSG 9: fully prepared, tested.

Queer as it may seem, there are those who actually try to justify terrorism. They claim that it is the weapon of the weak against the strong, and maintain that it is a legitimate act of war. This is ideological solecism, and to give it a moment's credence is a sin in itself. If one has a grievance his target is its author. To strike at a third party in order to coerce your adversary is worse than criminal — it is foul. The terrorist thus places himself outside of any considerations of respect or pity. He is worthy of all the mercy we afford the rabies virus.

In general, we wring our hands and whimper. But not, however, *all* of us. Good men, worldwide, are growing angry. And with the anger may come the will. The hard line is indeed unfashionable at this time — at least in the Western World. But the case is still not hopeless. Certain groups are now organized to take suitable action against this hideous social chance.

Pre-eminent among these is GSG 9 (*Grenzschutzgruppe 9*), the special commando of the German border patrol, conceived at the Munich Olympic Games disaster of 1972, and consecrated at Mogadishu in 1977. This unit is now fully



SOF columnist Jeff Cooper (left) with Ulrich Wegener, Commander of GSG 9 since its inception in 1972.

prepared and fully tested in action — a bright, sharp, and finely tempered sword ready for use wherever the Federal Republic of Germany may send it.

I first met GSG 9 and its distinguished commander, Col. Ulrich Wegener, in 1974 when it was just begun. The matter of pistol training was discussed, and my opinion was that such an organization probably had little use for handguns since its missions would always be tactically offensive and thus pose scant need for personal defensive armament. In this I was wrong, for counter-terror tactics can include what might be termed the "Orange-attack" calling for such violent and athletic movements (down ropes, through windows, roof-to-roof, etc.) as almost to prohibit the carrying of a proper weapon of offense. Four members of the commando did attend one of my overseas sessions, but much water has run under the bridge since then and there is now a good deal of new shooting theory to sort out.

Shooting is not the primary business of GSG 9, but its people must be able to shoot better than most if the occasion arises, as it has in the past and will again.

Currently staffed with under 200 men, GSG 9 is a small unit. It must be, for its targets are pin-points and it is very, very elite. One of its officers told me in '74 that he did not think the Table of Organization would ever be filled because he didn't think there were 180 men around who could measure up. Start with an advanced academic degree, medal-out in the Olympic trials, qualify in several languages, check out in flying, mountaineering, power swimming, hand-to-hand, and driving, and you may be considered — assuming your attitude and general appearance are superior. This is a veritable troop leader's dream!

Col. Wegener — ideal leader.

Counter-terror is a very modern discipline, and its doctrine is still formulative. In Col. Wegener GSG 9 has an ideal leader, for he is a quick-minded, inquisitive, scholarly man — brilliantly

pioneering in his new field. On this last occasion I set out to interview him about his spectacular success at Mogadishu, and he wound up interviewing me about combat shooting. There were certain technical failures at Mogadishu, and Wegener is not a man to let such matters drop.

Astonishing as it may appear, the men of GSG 9 carry the pistol of their choice. This policy is less likely all the time now in the U.S. and practically unthinkable in Europe.

But the colonel said, "Confidence in one's weapon is the big thing." (Where have I heard *that* before?) and the golden boys are given a free hand.

Entebbe and Mogadishu.

Naturally this is not the perfect answer in every case. At Mogadishu the first man to confront the head goblin in the cockpit doorway was carrying a .38 cal. Chief. Although he neatly placed all five rounds in the man's mid-section, nothing happened. (Hardly to *my* surprise). The grenade that was thrown in response by the terrorist was a Russian flash bomb, and the fact that it killed no one was due to its own inferior quality rather than expert defensive weaponry. Col. Wegener pointed out that he was following a ministerial directive stipulating Geneva Convention ammunition. (Will politicians *never* learn to leave tactical matters to tacticians!) He has had that directive rescinded, but several people who were in that airplane are very lucky to be alive. There are things you can load into a Chief that will probably do much better, but a Chief is still not the right tool for that job.

What is? That's a good question, and we considered it. If *you* had to dive through a smoking, two-foot hole into the dark, expecting to confront several heavily-armed maniacs in a crowd of terrified non-combatants, what would *you* pick? The impact ballistics of small arms are something of a specialty with me but I certainly do not have all the answers. The lads I met later on the range were sporting

a variety of frangible projectile ammunition for their sidearms, but you can only get so much out of a given combination of mass and velocity, and in the case of small-caliber pistol cartridges this does not seem to be enough.

Pistolcraft aside, I was especially interested in certain details of the two big strikes — Entebbe and Mogadishu. It is not widely known that Wegener was invited by the Israelis to observe at Entebbe, but he was indeed there. He also was slightly wounded by — of all things — a bayonet. (I guess it was lucky that he was not bitten by a snake, everything considered.)

I had assumed that Col. Netanyahu, the Israeli battalion commander who was killed, was hit by a 9mm Uzi bullet — because of his gradual response. As it happened he was killed by a Ugandan G-3 (308) that took him from behind and just clipped through the side of the neck, cutting his cephalic blood vessels on the right. Such a wound would deliver no shock, causing death by quick bleeding.

The Ugandans, such as they were, were using 308s, the pirates 30 R.S. (Kalashnikov), and the Israelis 9mm Parabellum. Of the five non-combatants who were killed, two were hit with Uzis and three with AKs. This is a remarkably low tally considering the vast amount of handheld automatic fire that was flying around.

Present at both actions and in command of one, Ulrich Wegener is now the senior counter-terror expert in the world. Even so he is still only an instrument of policy, and unless that policy is the right one no amount of technical and tactical brilliance will suffice to root out the evil once and for all. That the policy must be international is a very serious obstacle in a fragmented world, but it would seem to be a matter about which a fairly large consensus may be obtained.

Counter-Terrorism Principles

Much as a local fiddler might ask Sarasati about violin techniques, I asked Col. Wegener for his opinion about a set of principles I had drawn up to guide counter-terror activity. To my considerable delight we agreed on every point, thus:

A. Terrorism must be stopped. It is generally successful at present so it is up to us to change that. The terrorist seeks to gain his point, to achieve notoriety, and — usually — to escape alive. We must deny these objectives.

B. Therefore, we must *never* grant his demands, under any circumstances, at any price, though we may frequently *pretend* to acquiesce.

C. Therefore, we must insure that no terrorist ever leaves the scene of his crime, unless dead or in custody.

D. Therefore, we must insure that no terrorist is ever identified or publicized,

neither personally nor by group or cause.

E. Therefore, we must insure that, if taken alive, the terrorist is quickly punished by due process in proportion to his offense. This may call for “star chamber” courts repugnant to free societies, but we must choose the lesser of two evils.

F. Therefore, we must seek maximum speed in responding to terrorist acts. They must be terminated before they can be advertised.

Col. Wegener was pleased to relate an example of the last point. He was recently alerted to a possible terror hit inside Ger-

many. (GSG 9 is directed to respond within one hour. In fact it is usually “wheels-up” in 15 minutes during working hours, and in 40 minutes when off duty.) A minister who was party to the alert came to the scene with all possible speed to observe the commando in action. Wegener met him as he arrived, to inform him that there was nothing to see since the episode was already over. You never heard about that one, did you? That is obviously the way to go!

Tactical Objectives

In deriving tactical objectives from the

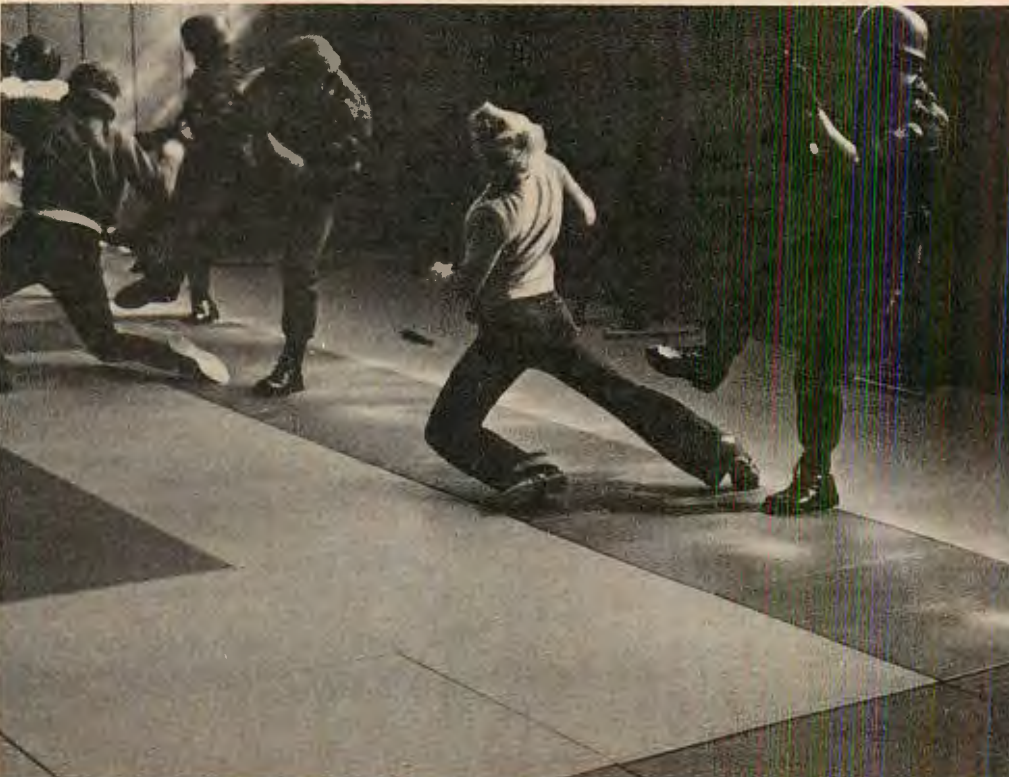

foregoing principles we may note the following:

1. Make sure that a terrorist action is really in operation.
2. Act *quickly*.
3. Prevent escape. (Live prisoners are not necessary.)
4. Agree to anything. (What *color* helicopter?)
5. Open an apparent exit. (Avoid the "cornered-rat" syndrome.)

6. Use whatever weapons are suitable. (Bio-chemical agents offer much promise.)

7. Protect the innocent, if possible.

In a free society one cannot shut down publicity, but it is very desirable to conclude action before the press people show up. Anyone personally interested in any hostage must be excluded. The fate of the hostage must be held secondary to the fate of the perpetrator. This sounds callous, but terrorists who get away will strike

again, and more people will die. We must bite the bullet.

The highly sophisticated GSG 9 does not publicize its tactics, for to do so would be to the advantage of the criminal, but its general skill level is most impressive. Every man is trained to do everything, and the atmosphere of dedication, comradeship, and pride is very apparent at the base. Wegener himself is a classic "up front" leader, and if he is not necessarily point man in every action, he is rarely more than a few steps behind. He tries every new technique himself, first, and at the age of 49 he is a spectacular athlete.

I have certain ideas about the improvement of the commando's small-arms techniques which need not be dwelt upon here. Col. Wegener will certainly acknowledge that nothing is so good that it cannot be improved. In this his viewpoint is both refreshing and inspiring, for the common police attitude is one of resistance to innovation. Counter-terror tactics frequently demand very careful marksmanship, combining extreme precision with decisive power. We have much to learn, and we are all hard at work.

Pride of service.

If there is one thing about GSG 9 that provokes criticism — at least in Germany — it is cockiness. Young men belonging to a unit of this sort naturally think well of themselves — with good cause. This may annoy some people, but it seems to me to be irrelevant. Pride may be viewed askance by Judeo-Christian theologians, but it is essential to the personality of a good soldier. The requisites of the fighting man are skill-at-arms, discipline, hardihood, valor, and pride. The absence of any single one of these components is fatal. Pride may be a sin to those who lack it, but it cannot be thought of negatively where force and violence are involved. It is amusing to hear a Nelson, a Custer, or a MacArthur derided as a "glory hunter." The pursuit of glory would certainly seem more respectable than the pursuit of votes, safety, or money. It is only when a man thinks that his title is enough — that it suffices to be a Marine, a legionnaire, or a Guardsman — and forgets that it is up to him to live up to and aggrandize that appellation, that pride becomes a weakness. There seems to be little danger of that in GSG 9. Its men think they are good because they *are* good, and it would seem that as long as Ulrich Wegener remains in command they will not be allowed to rest on their laurels.

Terrorism, like smallpox, must be eliminated — tossed into the garbage can of history along with the Inquisition, piracy, and the Black Death. It can be so eliminated if we so will, and the agencies of our will may be organizations like GSG 9, and men like Col. Wegener.



LEFT: Hand-to-hand combat with and without weapons. ABOVE: This is it. The standard equipment of every GSG 9 officer weighs 120 kilos and includes everything from machine guns to running shoes. BELOW: The weapons are there, but the name of the game is to do it without shooting. Photos: Globus Press.



They Can Run, They Can Hide: But Will They Fight?

Ft. Benning Noncoms Think The New Volunteer Army Won't

Feature & Photos by Marv Wolf

SHEETS of rain wash the high roof of Theater No. 3 at Ft. Benning's Sand Hill. Outside the air is thick and oppressively hot. Inside, the floor is slick with water tracked in by the boots of some 800 soon-to-be infantrymen. They doze in their seats in air-conditioned comfort, while a handful of their wives, sweethearts, parents and siblings crane their necks from the back rows for a glimpse of their boy.

The lights are dimmed and the program begins with an epic poem, *I Am The Infantry*, presented amid a three-screen pastiche of old war photos and patriotic music. It is narrated by a boyish tenor voice on tape.

The lights come on and the band strikes up an abbreviated version of *Ruffles and Flourishes*. The soldiers surge efficiently to their feet, while their families, confused, struggle halfheartedly out of their seats. A trio of officers strides briskly down the center aisle to the stage. The chaplain delivers a brief invocation, then tells everyone to sit. Hardly have they found their seats when the unmistakable first notes of the National Anthem sound. Everyone gets up again. The house lights go off and a spotlight plays on an American flag, waving in the breeze

created by an off-stage fan. It is all pure Wizard of Oz, pseudo-patriotic humbug, and it fires up the families as it always does.

A young staff officer moves to the microphone and delivers an embarrassingly long introduction of Brig. Gen. John E. Rogers, assistant commandant of the Infantry School. It is a list of his past assignments, education, awards, decorations and achievements.

Rogers tells the 70-odd civilians that they are about to witness an important rite of passage, usually conducted outdoors, as the trainees from four companies become full-fledged infantrymen. He tells them that he is aware that many of the fathers and older brothers present had once been soldiers, had long ago perhaps gone through the same sort of training these men had just completed, and that they, the parents, could be justifiably proud of these new infantrymen, this new breed that now becomes part of the fighting edge of the nation's defense.

Before I ever got to Ft. Benning I'd heard plenty about these new soldiers. From the USO receptionist at the Atlanta airport, who shook her curls in disgust. "They don't know how to take care of themselves," she says. "They come in

here with their uniforms all messed up, and they've just given all their money to the Hare Krishna and the Moonies, and they want someone to make it all okay for them — they're not sure what to do next."

And I'd heard about them from my seatmate on the Atlanta-Columbus flight, a McDonnell-Douglas engineer who has spent the last 30 years working with the Army, in recent years on the Dragon missile. "It's a very complex weapon and a very expensive one. The new soldiers we get now seem to have a lot of trouble making it work properly — they don't seem to get enough training. We're working with the Army now to try ways of simplifying or improving it so these new kids can make it work the way it's supposed to," he says.

And I've heard about the new breed from the fiftyish lady at the car rental window, who has seen soldiers come and go through the Columbus airport for at least 20 years. "They sure ain't what they used to be," she says. "They can't even tie their own shoelaces. They have no respect, no pride. They couldn't find a job on the outside, or they're one jump ahead of the law, so they joined up. They're scum. Nothing but scum."

THIS PAGE: Infantryman presents his camouflage attempt for inspection.



RIGHT: Trainee rushes toward the objective during assault training.

Oh yes, scum. Some things don't change. Twenty years ago at Ft. Ord, Calif., I was allowed my first Cinderella pass. I chose to spend it strolling aimlessly along the streets of Oceanside in my ill-fitting Class As. I was only 17 and broke, but after seven weeks of basic, a chance to leave the post, even for a few hours, was irresistible. After an hour I was ready to go back. "Scum, they're all just scum," said the druggist's wife to her pimply, biscuit-shaped daughter as I browsed the candy counter. She said it loud enough for me to hear.

I came to Ft. Benning in search of a myth; the basic training I went through in 1959 was tougher than what the current crop of recruits faces. I remember my own drill sergeant's derision as our platoon of hopelessly inept, out-of-shape mama's boys was introduced to the mysteries of right and left face, the M1 rifle and the Spirit of the Bayonet. "This ain't nothin' — nothin' at all," he spat. "Why when I took basic there was a war on. It was tough. Nobody gave us an inch. None of ya would have lasted two weeks."

Thinking about it later, I was sure *his* drill sergeant delivered a similar lecture. As did the drill sergeant of his drill sergeant, as far back as there were such men, even back unto Caesar's legions. I think there have always been veterans sneering at their new recruits, telling them how tough things used to be, how lucky they were to be going through now, whenever that was.

"It's a psychedelic Army."

But this time, I'm afraid, it's true. And it's only partly the Army's fault. Only partly, because the Army has to answer to Congress, and because the Army has to take its new recruits from the nation as a whole, and the nation's youth plainly does not arrive at the Army reception station with much respect for discipline.

One West Point lieutenant colonel, a man with 24 years service, until recently an infantry battalion commander, spelled it out for me. "I'm a stern disciplinarian, but I can't even control my kids. My 13-year-old, sometimes. But not my 16-year-old daughter. I tell her to be home at a certain time, she tells me to stick it. I tell her she must, she says she'll move out and live as she pleases. With that kind of situation in so many homes, how can we expect the young soldiers we're taking into the Army to automatically accept discipline? They won't. So if that's how society in America wants it, that's how they get it. We used to talk about the brown-shoe Army and then the black-shoe Army. Now it is a psychedelic Army. Everyone goes his own way. They learn, pretty quick, that we can't force them to do anything anymore."

Another colonel, and another point of view. Col. Hal Van Meter commands the First Training Brigade at Benning. Tall,





slim, boyishly handsome, he might have been Central Casting's choice for the role he plays. Certainly his appearance must be tremendously reassuring to the parents of all his soldiers-in-training, many of whom trick to Benning from as far away as Oregon to see their sons graduate as infantrymen. Van Meter is a local boy, a Columbus native from the right side of the tracks, high-school classmate of the city's influentials, by his own accounts a Vietnam hero, a romantic, a revolutionary who works within the system for change. Van Meter likes to talk about himself in the third person, punctuating his accounts with brisk, vivid gestures. He's his own best public relations officer.

But Van Meter, for all his theatrics, his political

savvy, his undisguised ambition, is very much a soldier. Returning from a company change-of-command ceremony, he came across a woebegone private waiting for a ride somewhere. The recruit was hatless, none too clean, shirt unbuttoned, fly half open, nasty sores festering on a couple of fingers, his breath the ripe odor of a sewer. He was disciplined enough to rise at the colonel's approach, but not to salute, slow of speech, forgetful of his "sirs." Col. Van Meter was gentle but firm in setting him on a course back to the orderly room for a hat. He inquired in detail after the state of his health. The private was told what to do, and how to do it. The colonel maintained his composure. He made it plain he cares mightily for the welfare of his men.





We had a few like this hatless, woebegone bumpkin in my platoon, 20 years ago.

No one spoke softly to us when we made a mistake. We were told what was expected of us, not cajoled. No one in my platoon ever met a colonel face-to-face, either. We dearly hoped not to. The sergeants were our mentors, and they made it plain enough that the only reason one of us would ever speak to an officer would be to answer for something for which the officer would likely send us to barbed-wire city, as the stockade was known. A soldier as unkempt and out of uniform as the one Van Meter came across would have felt the full wrath of a drill instructor's fury. He would surely have been made the bad example, marched in front of the platoon, his sins listed in ex-

cruciating detail, his punishment swift and sure. I don't remember anyone in my platoon that a flint-eyed sergeant would have allowed to become so obviously unhealthy.

But today's officers are much less remote. They explain to their troops why things are necessary. They sell policies and programs. They go with their men on the grueling road marches. They talk, even joke with them. They are no longer demigods. And they are no longer feared: on the range, where after 40 hours of instruction the best TOW and DRAGON gunners in each company are allowed to fire for the first time, one of the \$3,000 live rounds, the DRAGON gunner scored a glancing hit on an immobile APC chassis about 1,000 meters downrange. His fellow recruits cheered and applauded extravagantly.





ABOVE:
Trainee
loads M-60
machine
gun on the
firing range.



BELOW:
While some
trainees lis-
ten to
lecture,
others
(upper right)
snatch a
few quick
winks.



The range officer casually asked the gunner his company commander's name. Even with three tries, this was a target beyond the range of the gunner. The company commander strolled over to inform the recruit that he was his company commander. The recruit nodded in agreement, evidently relieved that the puzzle was solved. Then the commander told his recruit to drop and do 10 pushups to help him remember the commander's name.

The recruit wasn't impressed. "What for? What did I do?" he demanded. A sergeant dropped the gunner for the required pushups while the officer stalked off in embarrassment.

Colonel Van Meter is aware that the products of his training are lacking in discipline. He doesn't apologize for it. He says that the privates he sends on to line infantry units are "motivated, highly physically fit, technically and tactically proficient in 40 basic infantry skills, and are relatively disciplined."

"The men won't fight. They'll listen but we can't force them."

The drill instructors and NCOs who serve on the instructional committees describe the new infantrymen differently: "I would not want to go into combat with these men," says M.Sgt. Campbell, non-com in charge of a squad tactics training range. Campbell was with the Second of the Fifth Cavalry in the Ia Drang, in 1965. An NVA bullet got him out of that valley of death.

"I'm gonna finish my 20 and get out," he says sadly, noting that day is less than two years distant. "Nowadays it's all politics. Make things look good on paper, get good numbers to report, cover your ass, and everything's okay. But, there's no discipline. They won't fight, if it comes down to it. There's nobody to make 'em do it. They'll listen if they want to, but we can't force them."

Campbell's confession startled me. I did not think an NCO would be so frank. I remembered how it used to be: there was them — the civilians — and us, the soldiers. You took care of Army problems within the system. You didn't wash your dirty linen in public. You told the truth, mostly, when asked, but you didn't volunteer. You didn't elaborate. But that was then. Now the noncoms are caught between conflicting obligations, torn between their traditional role as the backbone of the Army and the new constraints of a rocking chair force. They understand the importance of their jobs in molding the new soldiers, but they feel their officers have let them down. When they try to get tough with their charges, the lieutenants and captains, few of whom have seen combat, chastise them for taking "ego trips."

At the DRAGON range a couple of noncoms almost belligerently availed



ABOVE: Recruits in 2nd Platoon, E Company, 1st Training Battalion, show off their new and still scabby tattoos.

RIGHT: Calling home is still important for recruits.

BELOW: Old WWII barracks still house two of seven Ft. Benning training battalions.



themselves of my ear. Their anguish and frustration came boiling out, practically nonstop, and soon more noncoms crowded into our circle, each with his own particular complaint.

"I don't care what the statistics say, lots of these guys can't read or write. They may be high school graduates but they don't know anything," said one 22-year veteran.

"These guys ain't gonna fight," said a staff sergeant. "First time one of those targets shoots back, they're gonna get their hats," he added.

Another NCO said he was afraid, "When the lieutenant comes back from the CP with an order to go up that hill over yonder, these guys are gonna call a vote."

Many expressed their concern for the future of the noncommissioned officers

Continued on page 75

MARCH/80



In Memoriam JOHN BERKE: A TRUE PROFESSIONAL 1935-1979

by N.E. MacDougald

TWELVE of us sat at the table, but none could eat. Berke was at it again. Skydiving incidents, war stories, bordello tales, and examples of imprudent judicial proceedings kept us from dinner. And all these meanderings had one thing in common: they were funny. Berke was one of those existentially funny guys.

Berke's energy rivaled his humor. It's difficult to remember him at rest. He was always moving or talking. Usually both.

He's dead now. Died with his boots on. The 2,707th jump was not a lucky one.

The late John Anton Berke, Jr., was Commander of the Confederate Air Force Airborne, Rebel Field, Harlingen, TX 78550. (see SOF, March '79).

Former Special Forces Vietnam Veteran, CAF Airborne Deputy Commander, jumpmaster, master rigger, and close friend, Gus Ditchman reconstructs Berke's premature demise as follows: "He exited with his sons Jack and James and two friends at approximately 7,500 feet and pulled at about 3,000 feet. His canopy opened normally but one of the steering lines broke and tangled around the slider. This happens fairly often when you're jumping a square. John compensated for the broken line by pulling a back riser, the usual remedy in that situation. He flew completely under control for about three minutes.

When he reached about 1,000 feet, gusts started buffeting him. He turned into the wind to begin his approach and again tried to free the slider. The canopy then turned again and he went into a flat spin (horizontal to the ground). John did everything he could. At 300 feet off the deck, Berke cut away from the square and deployed his reserve chute. But it was too late..." Ditchman estimates his friend was a couple of seconds away from life.

Yet Ditchman refused to shed a tear for Berke. He explained: "John wouldn't have liked his friends running around with long faces. He was funny in life and he was even funny in death. Before the funeral, I attended the



reading of John's will. John had written his will the way he talked. It was short and it was funny. Very funny.

"We talked about the future of the CAF Airborne and decided that to honor John, there would be no more Commanders, only Deputy Commanders. We consider Berke on permanent leave of absence to the Master Rigger.

"After the funeral I realized that of the 15 of us that began the Airborne, only two of us are alive, excluding John's two sons."

Publisher Brown attended Berke's simple funeral and noted that at its conclusion the second stanza of the "Star Spangled Banner" was read. (Berke wore CAF Airborne cammies and black beret.) Afterward, Brown attended a wake at Berke's home. About 50 people attended and the drink of choice was Jack Daniels.

Brown had been negotiating with Berke to use the CAF Airborne's new operations area near Houston as a permanent staging area for Parachute Medical Rescue Service, a nonprofit rescue organization of which the publisher is president. Plans included a C-46 to support any rescue missions in Latin America. From Brown's conversations with Ditchman and other Airborne members, it appears that some such agreement may be forthcoming.

Berke lived a full life. A Texan by birth, he graduated from the University of S. Mississippi in 1955. He then was a defensive back for the Pittsburgh Steelers and later joined the Marines. He graduated from Southern Methodist University's law school in 1962. The Navy reactivated Berke in 1968 and sent him to Vietnam. On 10 March of the following year, the Crusader fighter he piloted was shot down north of Hainphong. Berke bailed out and landed in the Tonkin Gulf where he spent 20 long minutes waiting to be rescued. In all, he flew 237 missions, 180 over North Vietnam.

Berke's parachute career is equally impressive. He first sport jumped with the CAF in 1968 and became increasingly enamored of it. On 22 April 1977, Berke made 90 jumps in 13 hours, demolishing the old daylight-to-dark record of 55 jumps. In August 1978, he received the diamond free-fall badge for spending a total of 24 hours in free-fall. He shares this distinction with only 50 other stalwarts.

Berke headed his own law firm in Houston, when he died at 43.

On Saturday, 1 December 1979, Berke made his 2908th jump, when his ashes were scattered at 12,500 feet. As the stanza of the "Star Spangled Banner," read at his funeral, puts it:

*On the shore, dimly seen thro' the mists
of the deep,
Where the foe's haughty host in dread
silence reposes,
What is that which the breeze, o'er the
towering steep,
As it fitfully blows, half conceals, half
discloses?
Now it catches the gleam of the morn-
ing's first beam,
In full glory reflected now shines on the
stream;
Tis The Star Spangled Banner O long
may it wave
O'er the land of the free and the home of
the brave!*

SOF salutes John Berke, patriot, adventurer and good friend.



EDITORIAL

NEXT TIME: DON'T FURTHER ENEMY AIMS

by George F. Will

FILE the following under "Notes for Next Time," for this is not the last time America will be held hostage.

Next time, the U.S. government should refrain from issuing statements of relief that Americans held hostage are not being "harmed." Americans deprived of freedom, strapped to chairs, and spoon-fed are being aggressively harmed. U.S. government assertions that such hostages are not being "harmed" are symptomatic of the confusion of a nation that is not half irritable enough about various forms of harm.

NEXT time, let it be drummed into embassy personnel that an occupation of an embassy is an act of war, and, as in all war, nothing should be done that furthers the enemy's aims. In such situations, standards of behavior for embassy personnel should be as strict as for an infantry corporal. As part of this policy, there must be no cooperation with a captor's tactic of selective releases.

Next time, the U.S. government should tell blacks and women to refuse to allow themselves to be used cynically by an enemy of their nation, to refuse to be used by being singled out for special treatment. Such treatment has the aim of embarrassing the United States, and works to the detriment of American citizens who remain hostages.

But, of course, women and blacks are two of the government-approved groups now accorded special rights back home because of their sex and race, in the name of "affirmative action." Such a nation cannot expect embassy personnel to show instinctive unity in the face of "affirmative action, Khomeini-style."

The first three hostages released included two of the many hostages who signed the petition asking the president to surrender to their captors' demands for the return of the shah. The third said he agreed with the petition. Washington's response to the petition was: What can you expect from people under pressure? But that is an affront to those who refused to sign, and ignores the fact that low expectations breed low behavior.

One of the three, a Marine, said: "I think the revolution is good." A second, another Marine, said that his captives gave him new understanding of "American imperialism." Such Vichyite behavior by embassy personnel is not the result of

two weeks of captivity in Iran, but of years of absorbing the spirit of a liberal culture. There is too much of the France of 1940 in the United States of 1979.

NEXT time, the United States should not allow the enemy (why don't we call enemies enemies, instead of "adversaries"?) to think U.S. responses to provocations will be predictable and gently modulated. Sometimes, of course, the United States must follow Lord Curzon's rules: Know your own mind and make sure the other fellow knows it, too. But sometimes the United States should make an effort to seem unpredictable, even volatile. Specifically:

Next time, the United States should not rule out military measures, including measures of eventual punishment when immediate rescue of hostages is not militarily feasible. Perhaps the U.S. government's first response should have been to send to Iran's Washington embassy a map of Iran with 100 military targets — dams, power stations, etc. — circled in red, and with plans for sealing off all Iranian oil exports.

Next time, the United States must not assert, with the matter-of-factness of a self-evident truth, that the safety of the hostages is its overriding imperative. Such an assertion should not be made because it should not be true. Vital national interests sometimes require lives to be risked, in battle and elsewhere. This nation has a vital interest in being respected, and in its self-respect. In some cases, these interests may be incompatible with the behavior necessary for guaranteeing the safety of or minimizing the risk to hostages.

Charles DeGaulle was a great statesman because he took the long view of policies' consequences, and faced the hard facts that must be in the foreground of life. One such fact he put this way: "The state is a cold monster." Not always, of course, but at times it must be.

WITH that in mind, and with next time in mind, this question must be faced: What could ever be worse than putting scores of hostages at risk? One answer is: the loss of millions of Americans in a war made more likely by the world's slide into anarchy, a slide accelerated by demonstrations of American impotence.

Copyright 1979, The Washington Post Company. Reprinted with permission.



TOP: The mainstay of ZR air mobile forces, aging French Alouette helicopter, lifts out a KIA, from deep inside Mozambique. ZR casualties, as per usual, were light. **ABOVE:** RLI trooper fires an RPG-7 which is used extensively by ZR security forces as they have not been able to purchase other anti-armor systems due to the hypocritical U.N. embargo.

TARGET: GAZA

Zimbabwe-Rhodesia's Biggest Raid Yet on Mozambique's Heartland

by Al J. Venter



From left to right, ZR troopies carry RPK-LMG with 40-round mag and bipod; FN with bipod and British Trilux L2A1 sight. RPD with bipod removed and AK-47. Soviet RPG-7 rocket launcher leans against tire.

In August, 1976, the Selous Scouts conducted the first sizable pre-emptive strike of the Rhodesian security forces against terrorist bases in Mozambique. Since then, numerous strikes have been conducted against Terr bases in Zambia as well as Mozambique. The Rhodesian government, now called Zimbabwe-Rhodesia, has always been closed-mouthed about the details of these raids, most of which have achieved phenomenal success. In an exclusive, SOF Africa editor, Al J. Venter, provides an inside look at two of the largest and most successful of these raids.

THE engineers had been busy for some time when the little man in the gray Mozambique Roads Department Land-rover arrived. He was surprised at what he found.

Scattered across the narrow approaches to the bridge at Barragem on the lower Limpopo River — almost exactly halfway between Kruger National Park and Xai-Xai, once a favorite South African holiday haunt on the coast — were dozens of crates, many of them unmarked.

These weren't ordinary packing cases; some were painted military tan; others had red stickers stuck on them which in-

dicated that their contents were P4 and PE9 plastic explosives used in demolition work. Across the way, a squad of Zimbabwe-Rhodesian troops in their distinctive jungle-green cammy uniforms lay behind a heavy machine gun which dominated the only road leading to the giant bridge.

Nearby were several mortar pits, manned by fresh-faced youngsters from across the Rhodesian border. All anticipated action; it was only a question of time. Others, guns slung casually over their shoulders were lowering some of the crates down the tall supports of Barragem Bridge where fuses and detonators were fitted.

An unmarked Zimbabwe-Rhodesia Air Force helicopter — painted in camouflage colors — had approached the bridge from upstream a little earlier; it hovered a while before settling down in a cloud of dust near a man who was directing much of the activity. Like the others, he wore camouflage, but no insignia of rank.

For a while, work on the bridge went on unhindered. Earlier in the morning this labor had been punctuated by the sharp staccato of automatic weapons fire which had died down as Rhodesian "troopies" mopped up pockets of resistance. In any event, most of them ignored it; they had heard too much of it when they had taken

the town closest to Barragem. Right now they were preoccupied with the task ahead, the incredible heat and legions of flies that stuck to their eyes and mouths and were not intimidated by the wave of a hand.

Now that Frelimo resistance had been broken they worked fast, for the bridge must be blown before dark. None of the 50-odd soldiers present at Barragem that quiet September afternoon doubted it would be.

Suddenly, one of the lookouts on the outer defense perimeter radioed in. Something was happening. He addressed himself to the officer in charge of the demolition group.

"Bravo Charlie, sir. Report coming in."

The officer raised his eyebrows momentarily and turned toward the young corporal monitoring a nearby radio.

"Let's have it then, corporal."

"Vehicle approaching, sir. Unarmed. Apparently a civvy in a Landrover. No escort that he can see either."

"Anything suspicious?"

"Nothing, sir. Bravo Charlie reckons the man is white."

There was a pause. The officer spoke again, this time in clipped military terms that reflected something distinctly British about his manner. "Right, corporal, let him through." Then he turned toward another man.

"Sergeant, take three men and cover the vehicle as it arrives. I don't want trouble."

"Roger, sir." The sergeant spat out the words in a way which indicated that he had been doing it for years. He rattled off three names and the "stick" moved off toward a slight rise in the embankment 20 meters away.

The Bulgarian halted his Landrover by the bridge.

The little man in the Landrover could best be described as a typically nondescript East European. His clothes, obviously designed for tropical work by someone who had never been to the tropics, were ill-fitting and unkempt. Hair tousled and fingers stained by nicotine, he was the sort of official one sees a hundred times over each day in any Central European capital.

Only later did the Zimbabwe-Rhodesians determine that he was a Bulgarian and that his designated task in Mozambique was to supervise road construction and maintenance in that part of Gaza Province in southern Mozambique where the soldiers were busy. What he did not know was that even as he pulled to a halt on the verge of the bridge alongside a group of soldiers who had formed a human chain moving some of the crates, his presence was already being reported to Salisbury.

**ZR troops
prep terrorist
positions with
British-made
81mm LIAI
mortar
mounted on
ZR-developed
mortar carrier.
Note MAG-
LMG mounted
on front of
vehicle.**

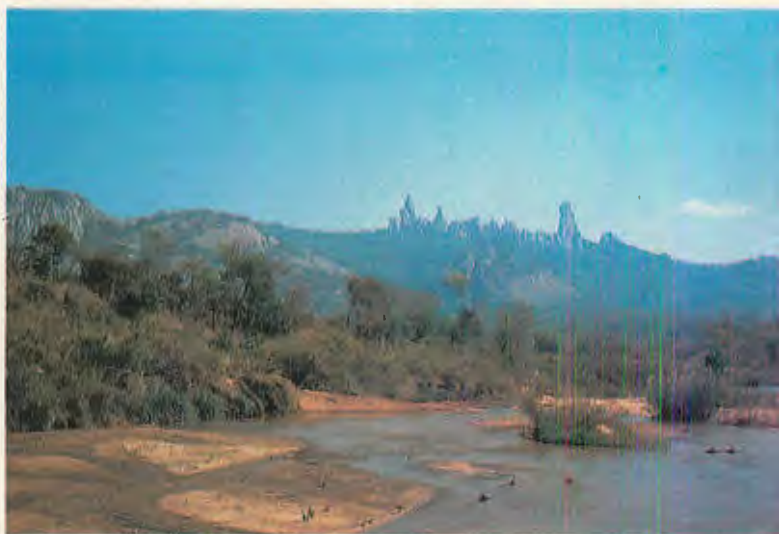

ABOVE: Example of rugged terrain encountered during ZR raid deep into Mozambique. RIGHT: Another addition to the ZR armory — a 12.7mm Degtyarev 1938/46 Heavy Machine Gun on tripod.



TOP: Thousands of miscellaneous small arms were captured and transported back to ZR. Pictured here are PPSH submachine guns, Sten gun, SKS carbines. **MIDDLE:** More raid booty. **BOTTOM:** Wide and weird variety of arms surface during ZR terrorist war; for example, this 20mm triple-barrel Oerlikon Type 665 anti-aircraft gun.

The Bulgarian sat motionless in his cab for a few moments before getting out. His mien was one of astonishment as the officer in charge approached. The two men greeted each other, but their initial reaction was perfunctory.

No one knows exactly what was said during that first minute or two and Salisbury is not commenting. What was clear to everyone nearby who managed to catch a few snatches of conversation was that the Bulgarian was not at all happy with what was going on. No one had told him that there would be "people working on my bridge today." There had been nothing from Maputo about a "repair team" and a squad of soldiers to guard them.

In good English he remonstrated. Why were these people there? Where was the authority? It was all so strange, even the uniforms. He was a good 200 miles from the Rhodesian border and the possibility that these men were the enemy probably never crossed his mind.

The Rhodesian shrugged and smiled. "It'll all be over in a couple of hours, perhaps sooner," he said. "Nothing to worry about."

The Bulgarian shrugged his shoulders. It had happened before, he intimated. The left hand did not know what the right hand was doing in Maputo, he rasped angrily. "Bureaucracy gone mad," he was heard to mutter by one of the soldiers.

Then his face changed. Suddenly, he had seen something he liked. He gestured toward the helicopter parked nearby.

"You are well organized," he said to the officer. "You even have your own helicopter ... French too — an Alouette?" he remarked almost rhetorically. The officer nodded. He paused a moment, then turned to the Bulgarian again:

"Would you like a ride in it?"

The East European beamed with delight at this unexpected bonus. He gestured eagerly in the affirmative. A little after dark the same evening the lights of Salisbury welcomed an unexpected — and thoroughly bewildered — guest. Zimbabwe-Rhodesia had taken its first Bulgarian hostage.

There is no word from Combined Operations Headquarters in Salisbury of what has happened to the little East European official except that shortly after arrival he was allowed to phone his wife in Maputo. He had just mentioned the fact that he was in Salisbury when the line went dead.

On 1 September, Zimbabwe-Rhodesia invaded.

It is ironic that the biggest strike ever launched by the forces of Zimbabwe-Rhodesia against a neighboring territory coincided with the 40th anniversary of Hitler's invasion of Poland on 1 September 1939. Until then, the efforts of the Salisbury government had been directed largely

against the forces of the two terrorist movements ranked against it; Robert Mugabe's Zimbabwe African National Liberation Army (ZANLA) which operates out of Mozambique, and ZIPRA — Zimbabwe People's Revolutionary Army — the brainchild of Joshua Nkomo, which is headquartered in Lusaka, Zambia.

In seven years of ongoing guerrilla warfare, Salisbury had studiously avoided harassment of the Mozambique government, its citizens or its property. The war was with the terrorists who came from this East African territory on the fringe of the Indian Ocean and this basic tenet was strictly adhered to even though retaliatory strikes across the ragged frontier were regular and intense.

The same went for the Frelimo Army — the FPLM or Popular Forces for the Liberation of Mozambique — though Samora Machel's soldiers were given short shrift if they intervened or were caught in a cross-fire.

Then, on 1 September, came what most observers agreed amounted to an open declaration of war. A large Zimbabwe-Rhodesian strike force spearheaded by jet fighter-bombers and ground support struck deep at the soft underbelly of the Maputo regime. It was a strike which made history, for part of it took place less than 100 miles from the capital.

Initially, a forward administration base to coordinate all aspects of the raid was established deep inside Mozambique territory more than 150 miles from the border at Malvernia. This coordination was so effective it will take Mozambique at least six months to recover.

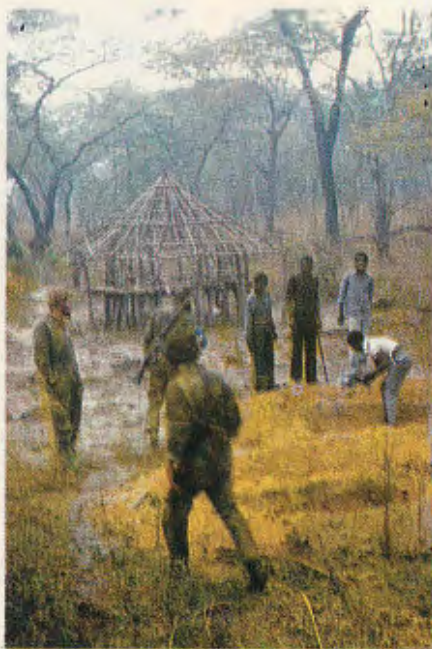

ZR troops search terr camp in Mozambique. Tremendous amounts of booty were returned to ZR to assist their war effort.

Ostensibly, the raid came because of an incursion into Zimbabwe-Rhodesia by 100 Frelimo regular soldiers who infiltrated the Plumtree area of the southwest in a bid to sabotage the main Rhodesian railway life-line leading to South Africa. In fact, the onslaught has much wider ramifications.

Altogether, five large bridges across the Limpopo River were destroyed. One of them was the huge multi-spanned structure at Barragem. Others were at Chicacate, Folgares, Canicado and Meginchopes. Roads were mined and various routes made impassable.

In simple terms, the target was Mozambique's huge southern Gaza Province which adjoins much of South Africa and Zimbabwe-Rhodesia's eastern border. It's estimated that about 50 percent of all terrorists who infiltrate across the border from Mozambique come from this region. Twice the size of Switzerland, Gaza has direct rail and road access to Maputo, which is still the largest terrorist supply port, a Russian-backed "Haiphong" in Africa.

It was these communications which Combined Operations Headquarters in Salisbury set out to destroy. And they did a thorough job, killing about 1,000 Frelimo and terrorist troops for the loss of 15 of their own men, 13 killed in a single helicopter crash early in the raid.

On to "The Russian Front."

The raid into Mozambique was divided into sectors. Apart from detachments who would "take out" the bridges, a large contingent headed for what is locally known as "The Russian Front," a stretch of road between Malvernia on the border and the garrison town of Mapai, which is the brigade headquarters of all terrorist activity in Gaza Province.

Although this stretch of road is only 35 miles long, it has seen some of the war's most vicious combat. It is known there are more than 3,000 ZANLA terrorists garrisoned at Mapai; among them, 150 Russian advisors do not conceal their presence.

1. Mapai.

Initially, Zimbabwe-Rhodesian jets dropped more than 20 tons of bombs on the kilometer-square installation. Ground forces met massive resistance from row upon row of slit trenches, which surrounded the installation. There were enough anti-aircraft guns to protect a city 200 times the size of Mapai.

From captives taken during the raid, it was disclosed that much of Mapai is a concrete underground complex with enough bunkers to house many times the number of troops it contained. Even a concerted mortar barrage which lasted

several days made no impact on the defenders.

But while Mapai's inhabitants remained intact, Rhodesian demolition teams were not inactive.

Together with air support, they were able to destroy about 100 T-34 and T-54 Russian-supplied tanks, permanently billeted at Mapai, together with their workshops. Also knocked out were the Mapai arsenal and most of the ammunition magazine in the fortress vicinity. When the main magazine exploded the blast could be seen for 50 miles.

Throughout the attack, anti-aircraft fire was heavy and concentrated. One pilot reported it was the heaviest flow of AA flak yet seen in the Southern African theater of military activity; much of it was directed by Russian and East German military personnel permanently stationed at the fortress town.

Mapai was left to fight another day. When it was obvious that taking the garrison town would cost more lives than it was worth, attention turned elsewhere.

2. The Troppo Scanner.

Again, through a hail of anti-aircraft fire, Zimbabwe-Rhodesian aircraft attacked another prime target, the Troppo Scanner, positioned along the "Russian Front" at Malvernia, which monitored every aircraft movement for several hundred miles. This huge electronic radar installation was another Russian contribution to the war; it was totally destroyed in the first wave.

Rhodesian pilots who talked about their exploits at Mapai and at the Troppo Scanner afterwards say it was like something out of a World War II movie. Thousands of air-burst shells were hurled at them and very few aircraft taking part in the raid escaped without holes in the wings and fuselage.

3. Malvernia, Massangena and Maxaila.

Other principle targets scheduled for Zimbabwe-Rhodesian forces were the FPLM Battalion Headquarters at Malvernia, Massangena and Maxaila further to the east. All three centers were obliterated, as were several other Frelimo military establishments in various corners of Gaza Province, including the towns of Mabalani, Mpuzi, Chicualacuala and others. That Salisbury meant business, no one in Mozambique was left in doubt.

While this work went on, scores of Zimbabwe-Rhodesian mine-laying teams — mostly Selous Scouts — were active throughout the territory.

Every access and approach road into the region was mined and any means of resupport from the south was sabotaged or knocked out. Dozens of Frelimo troop



TOP: Panhard armored car carrying 90mm gun is mainstay of ZR Armor Corps. Recently, ZR forces captured and returned to ZR an unspecified number of Russian T-54 tanks from Mozambique. **BOTTOM:** Rhodesian "home grown" armored scout vehicle, carries twin Browning light MG's in front and MAG light MG on side. For more information on twin Brownings and Rhodesian-developed armor, see January 1979, SOF.

carriers, armored cars and tanks — most of them T-34 and T-54s — were destroyed. It is estimated that, apart from the number of FPLM and terrorist forces killed, four times that number were wounded, many of them seriously.

Several anecdotes emerged from this onslaught, some of them humorous.

In one town taken by Zimbabwe-Rhodesian soldiers, they were approached by an old black man who wished to go back to his home in Salisbury. He told a curious tale.

Apparently his two sons were abducted by terrorists several years before. One, he found out later, had returned to the country of his birth to become a seasoned insurgent fighter. Concerned about their activity, he followed them and eventually settled near one of the large ZANLA bases at Malvernia. He was bitterly disappointed at the standard of life in Mozambique; he admitted that he found it difficult to find enough food to survive. He deplored doctrinaire Marxism such as was being espoused by Frelimo cadres.

After discussing the matter with his aged wife, it was decided he would ask permission to return. He was taken back to Salisbury as a guest of the Zimbabwe-Rhodesian Air Force.

There were also a few incredibly lucky escapes. Once a Bell Iroquois helicopter was hit by an air-burst RPG-7 rocket. The chopper exploded on impact with the ground and Senior Aircraftsman A.J.C. Wesson was killed instantly. Yet the pilot, who was thrown clear, walked out of this inferno. He suffered only minor fractures and lacerations.

There was also the additional bonus when a curious FPLM patrol attacked the Forward Admin Base, believing it had stumbled onto an enemy mine-laying team. They were greeted by fire from several hundred enthusiastic young Rhodesian Light Infantry troopers, who killed 23 FPLM soldiers and captured one. The Rhodesians suffered one man wounded.

Or the mine-laying team caught exposed on the ground when its chopper did not arrive to pick them up at dawn. Eventually it was obliged to set the bush alight to keep a 100-man FPLM company at bay and was hauled to safety in a "Hot Extraction" operation by an aircrew using the fire to get its bearings. Close.

This team was on the ground long enough to hear three of its landmines blow up vehicles being used to head it off.

"Pull out!"

Then, almost exactly as it had begun three days before, word came from Combined Operations Headquarters in Salisbury to pull out. Massive damage had been done to the enemy. Left behind was a wake of destroyed brigade and battalion headquarters, company bases, towns and villages where Frelimo's army had enjoyed a presence — and the five damaged bridges.

It was acknowledged that most of the survivors were now wandering about the Mozambique bush baseless and leaderless. Subsequent intelligence reports showed that only a week later food was already a problem. Gaza was effectively cut off from the outside world. Summer rains which started while the raid was in progress will make any effort at normalizing the situation extremely difficult, at least until late this year.

Strike on Chimoio.

Three weeks after the raid into Gaza Province, Zimbabwe-Rhodesian security forces turned their attention to an area to the north of that region. It lay directly east of the port of Beira and because of good rail and road links has also played a prominent role in the war. In this area was situated a major terrorist camp and stag-

ing post known as Chimoio. For a long time Chimoio has been named as the Supreme Headquarters of the ZANLA offensive into Rhodesia; it housed offices of the ZANLA chief of staff, the head of the ZANLA army and a small Russian contingent.

The strike on Chimoio took place early in October, 1979, and lasted six days although it was scheduled to be a short operation. It turned into the biggest fire fight of the seven-year war.

For a long time Chimoio's position had not been pinpointed. During 1978, an earlier Chimoio had been knocked out, but Salisbury was aware that it had been relocated and rebuilt — this time with Soviet and East German assistance. All that was known was the new Chimoio was a considerable advancement on the old one. Not only were the trenches deeper but there were reinforced concrete bunkers housing anti-aircraft positions cut into the side of a dominating mountain which was christened "Casino."

For months the Rhodesians searched for the new Chimoio. Then two Special Air Services troops on their way back from a recon suddenly came under extremely heavy fire as they crossed a crest of hills about 40 miles northeast of Umtali. Obviously they had accidentally stumbled onto something. Both men were wounded but they managed to haul themselves to safety and report the contact.

Salisbury sent in a squadron of spotter planes and gradually a pattern emerged. Ground recon provided even more dope; Chimoio had been found again. What emerged in initial intelligence reports was a huge bush complex, perhaps five miles across, dominated by an 800-foot mountain.

The Rhodesians called their attack on the new Chimoio "Operation Miracle." The results are very nearly miraculous for it was originally estimated that there were about 2,000 terrorists in the camp when the onslaught began. In fact there were closer to 7,000. The entire Rhodesian attacking force numbered about 200; when it was all over, six days later, five of them were killed against more than a thousand enemy killed and twice that number wounded, many seriously.

The operation started five days before scheduled. The entire strike force was called into Inkomo Barracks in Salisbury to prepare for what was anticipated would be a short, sharp little engagement. Vehicles were painted Frelimo colors to allay fears of the locals on the way in.

There were a few logistical problems. An entirely new road had to be cut by Rhodesian engineers to join with the main north-south highway near the old Portuguese town of Vila Pery. Even so, conditions were so bad on that first day before reaching Chimoio that it took the strike column nine hours to cover the first 35 miles.

A more serious problem resulted from heavy ZANLA mortar fire encountered by Rhodesian Light Infantry stop groups which earlier parachuted into position near Chimoio and spent the entire day waiting for the strike force to arrive.

Target: Cruzamento.

The first target inside Mozambique reached by the ZR column was the town of Cruzamento, a Frelimo battalion HQ. Earlier it had been hit by ZR Hunter jet bombers and then obliterated from the map by ground forces.

Chimoio's first line of trenches was reached that afternoon about two hours before dark and the onslaught began in earnest. Within an hour, two ZR soldiers were killed and eight wounded, several of them in an armored car that fired at a position at point blank range; its crew was caught in the back-flash.

ZR column on the move into Mozambique. ZR-built Crocodile armored vehicles pull 12 pounders.

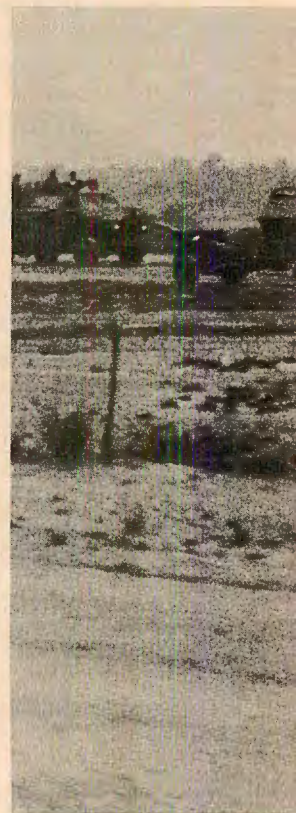

Fighting went on from one line of trenches to another; much of the actual conflict was hand-to-hand and involved use of small arms and handguns when positions became too tight. It was then that the commander of the strike force became aware that earlier bombing raids by ZR jets had made little impact; most of the positions they had been pounding had been dummy ones, built alongside the real targets which were dug into the side of the mountain.

Many of the big guns that did the most damage were set on rails and the ZANLA troops were able to roll them into safety if they needed to. Casino Mountain had been penetrated by dozens of these caves

and was completely surrounded by AA positions and mortar pits.

Part of the solution to the problem came that night when one of the Rhodesians was able to scale an adjacent hill and spot the enemy flashes. His findings were radioed back to Salisbury and when the ZR planes came in at dawn they were able to cause real damage for the first time. The ZANLA forces now started taking heavy casualties as the Rhodesians moved forward.

During this phase, ZANLA mortar fire was found to be extremely accurate for no apparent reason: most of the mortar pits used by the terrors were out of line of sight. Then it was discovered that machine-gun positions on different parts of the mountain would home into a strike position and raise the arc of fire into the air until they crossed; tracer bullets would then provide the mortar crews with a bearing.

cause of bad weather; now they were into their second day of actual ops — four days altogether. And they had been supplied with enough food, smokes and ammo for only 48 hours.

When the signal for back-up came through, emergency supplies were rushed to the invaders. At that stage, admitted a few of the original group, cigarettes were probably the biggest personal need.

Saturday, the third day, arrived with a big breakthrough in ZANLA lines. Spear-headed by armored cars, the main camp was overrun and its inhabitants forced to flee. More than 150 tons of food were found cached there: all of it marked — “Gifts of the Swedish Government.” There were also 25 tons of United Nations UNICEF medical supplies; much of it was airlifted back to Rhodesia, because it was of such high quality.

Rhodesian territory by the same road taken on the way in. Only when men were well away from Chimoio were they told that another group of Frelimo tanks — many of them T-55s — was approaching from the south — there were 26 of them, backed by more 1,000 regular Frelimo troops as well as a squad of East German paratroopers. This latter contingent was showing its face actively in Mozambique for the first time and made contact with ZR units the following week, killing one RLI troopie in a 10-minute fire fight. It was the first time that East Europeans had taken a direct part in the war.

The Chimoio story was not quite over. The Salisbury government gave the terrorists 24 hours to regroup at Chimoio before sending in a flash RLI strike dropped by air. They managed to kill several hundred more enemy before they were pulled out by chopper an hour later.

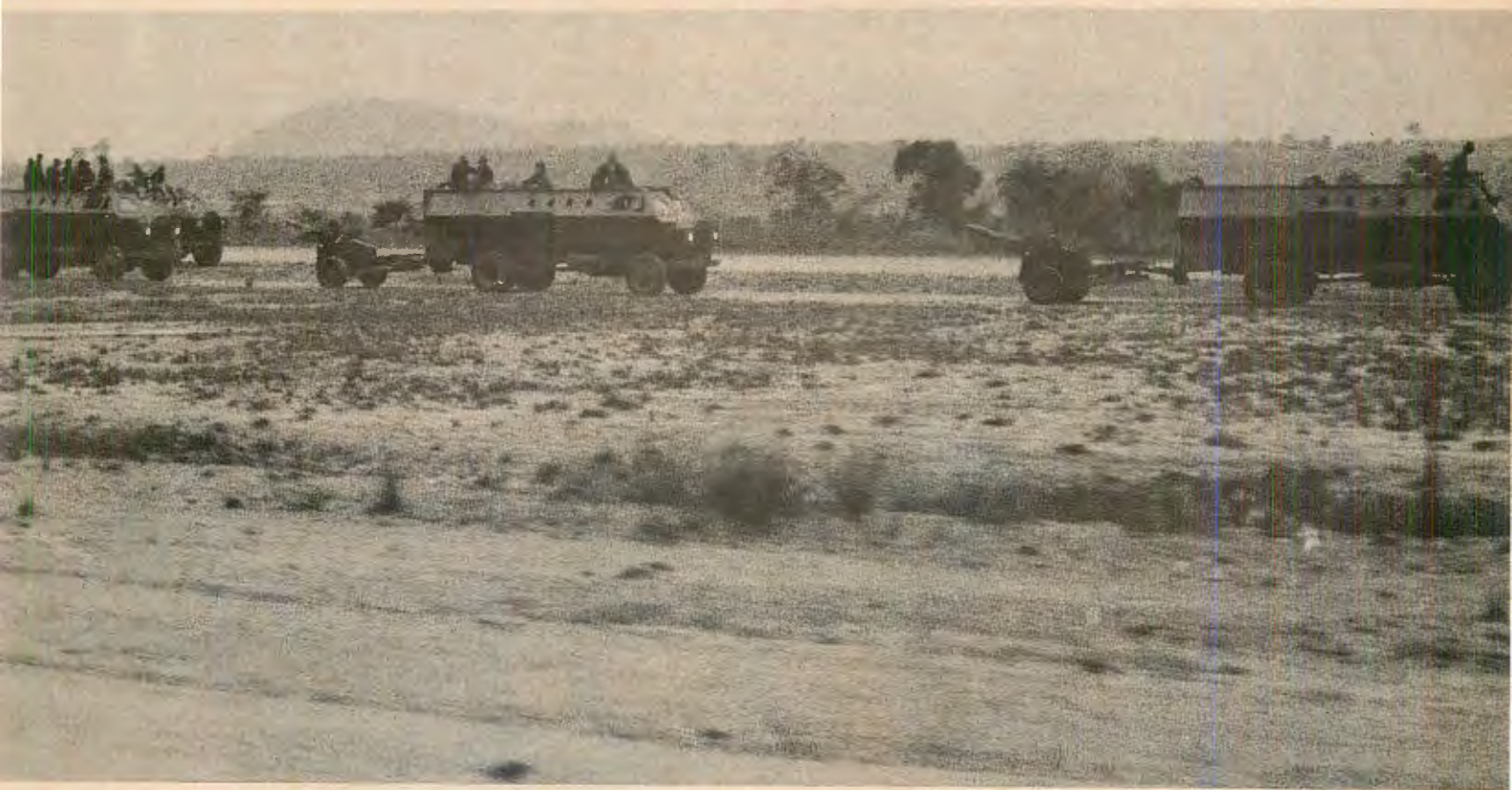

Perhaps the most fortunate capture of this strike came on the first night. One of the men taken prisoner was a ZANLA engineer responsible for liaison with Russian technicians building the new Chimoio. With persuasion he was able to provide the Rhodesians with a detailed plan of the camp and its defense positions.

It was then found there were five camps and not one as originally believed. The prisoner also clarified the number of enemy.

Meanwhile, food and ammunition among the attackers was running short. The strike force had been delayed for two days prior to entering Mozambique be-

The same evening five T-34 tanks flying Frelimo colors approached Chimoio from the south. A small RLI stop group left to guard and mine that road was able to put one of the tanks out of action before calling in artillery positioned at a small open piece of ground west of Chimoio named “Madison Square.”

The artillery managed to knock out another tank and score a glancing hit on one more before the survivors pulled back.

Sunday brought more ground attacks and mopping-up operations. By lunch time the entire position had been secured and the force ordered to pull back into

With major ZANLA bases in Mozambique knocked out, Zimbabwe-Rhodesian forces turned their attention to Zambia, striking at a complex of ZIPRA insurgent camps northeast of Livingstone in southern Zambia. Again several hundred of Joshua Nkomo's forces were killed for the loss of one RZ troopie killed and several wounded.



SELOUS SCOUTS VINDICATED

Missionary Murders Attributed to ZANLA

37 missionaries or members of missionary families have been murdered in Rhodesia in the last six years. One of the most atrocious incidents was at the Elim Mission in the Rhodesian eastern highlands on the night of 23 June 1978 when terrorists hacked to death eight British missionaries and four young children, including a three-week-old baby.

It is alleged by terrorist leaders that these murders were the acts of a Rhodesian military unit known as the Selous Scouts. No responsible observer of the Rhodesian scene takes these allegations seriously and it would, of course, be absurd for the Rhodesian government — which seeks to promote a feeling of security in outlying areas—to countenance any such action on the part of its Security Forces.

Ian Smiley, editor of the British journal, *Africa Confidential*, who spent some time in Rhodesia as a correspondent for *Time*, the BBC and the *London Observer*, in an article in the *National Catholic Reporter*, 4 November 1977, writes: "Black Nationalists have claimed that all missionary killings have been perpetrated by the Selous Scouts, the Rhodesian Army's mixed-race trooper elite, who occa-

sionally masquerade as guerrillas in order to test black villagers' loyalty.

"But after assiduous digging, I have failed to exhume any evidence to support that theory. With the possible exception of one case, where a black doctor employed at a Swedish mission station was mysteriously killed after being warned by the authorities for giving medical aid to guerrillas."

Writing for the *New York Times* on 28 June 1978, Michael Kauffman says, "Commanders of the Mozambique-based guerrillas have charged from Manhooto that many of the mission attacks — including the latest in the Buma Mountain region, in which three children and a three-week-old baby died — had actually been carried out by black Rhodesian troops intent on discrediting the Nationalist cause.

"This is dismissed as nonsense not only by Rhodesian government officials but also by church representatives who in the past have shown a tolerance for the guerrillas and have on occasion charged the government countenances torture by its armed forces."

Writing in the *New York Times* on 11 February 1979, Richard West, a cor-

respondent for the English publication, *The Spectator*, says, "Although some mystery attaches to one of the first killings of priests [the suspect escaped from his cell at Victoria Falls], almost nobody I have met in Rhodesia, black or white, believes that the Elim and other massacres were carried out by the Selous Scouts or other troops. One could not get away with such things on the continent of the 'bush telegraph'."

In an article in the *Toronto Star* of 2 July 1978, Peter Youngusband describes the Elim massacre as the action of Robert Mugabe's forces: "A significant pointer to Mugabe's intentions was given me by the Rev. Gary Strong, a respected Rhodesian churchman and liberal. He told me, 'I personally saw a statement by Mugabe while I was in Geneva during the Rhodesian conference there, stating that his forces would continue acts of brutality and killings against innocent men, women and children to force a psychological fear in the people of Rhodesia. He did admit that he did not like this tactic but he felt this was the only way to effect his policy'."



POLYGON BARREL DESIGN INCREASES ACCURACY AND STOPPING POWER!

H&K's P9S .45 cal ACP

A Law Enforcement Must

- Light Weight—Less than two pounds (31 oz.)
- Eight power packed .45 cal ACP rounds (7 in magazine—1 in bore)
- Delayed roller-locked slide system retards recoil forces
- Shoots faster; ½ lb. lighter; 1" shorter than U.S. Govt. Mod. 1911 .45 ACP
- 3½ pound trigger pull—3 shots in under an inch
- Barrel/slide assembly lift off
- 4% increase in M/V



H&K

HECKLER & KOCH, INC.

933 N. KENMORE ST., SUITE 218
ARLINGTON, VIRGINIA 22201 • (703) 525-3182

Inquiries are invited for our complete line of fully automatic weapons and counter-sniper systems.

Vol. 10, No. 1

THE NEW PALADIN PRESS CATALOG



NEW ACTION TITLES FOR THE 1980S:

- *FBI Handbook of Forensic Science
- *Ninja Combat Method
- *Modern Self-Defense
- *Scouting and Patrolling
- *Survival Poaching
- *Getting Even; The Complete Book of Dirty Tricks



NEW TITLES

Terrorist Explosives Handbook Volume I:

THE IRISH REPUBLICAN ARMY

The decade of terrorism since 1969 in Northern Ireland has resulted in nearly 2000 deaths. Bombs and other explosive devices basic to the IRA arsenal have played a gruesome role in this carnage. Impersonal, horribly efficient, and totally merciless, the bomb respects neither age, nor sex, nor politics. Volume I of the **Terrorist Explosives Handbook** is a concise, up-to-date intelligence report of the current IRA bomb campaign throughout Great Britain. The weapons range from crude, hand-thrown nail bombs to the dreaded SA-7 heat-seeking missile. British countermeasures are examined, such as mechanical bomb sniffers and the "Wheelbarrow" robot bomb handler. Learn the behind-the-scenes story of these savagely effective devices used by the world's most durable urban guerrilla movement. 5½ x 8½, softcover, photos and drawings, 31 pp. **N.D. \$4.95**

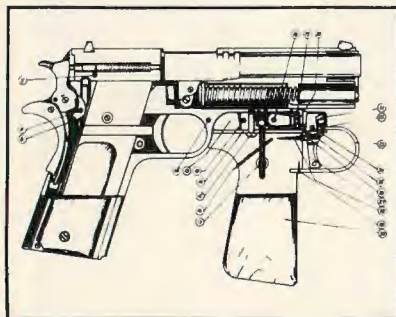

AUTOMATIC & CONCEALABLE FIREARMS DESIGN BOOK, VOL. II

Offers ten new firearm designs for the home gunsmith or machinist. Three of the designs cover the **selective fire** modification of the Colt .45 1911A1, the Heckler & Koch 91-93, and the Winchester Model 64 .22. The other designs present unusual improvised weapons, with the home armorer in mind. These include the Revolver Knife, .22 Knuckle Gun, .12 Gauge Shotgun Pistol, Mini .22 Magnum, Front Bolt Action Shotgun, .22 Short Mini Machine Pistol, and two more. The high quality drawings are each accompanied by text explaining construction and operating details. 8½ x 11, softcover, photos and diagrams, 64 pp., ISBN 0-87364-177-9. **\$12.00**

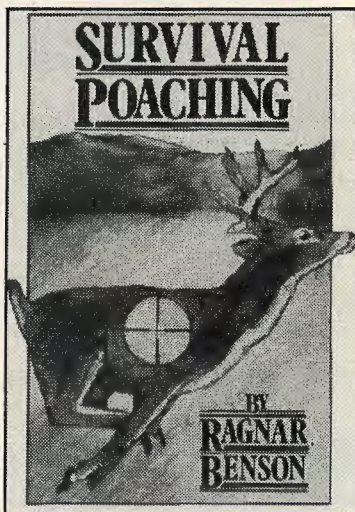

SURVIVAL POACHING by Ragnar Benson

Here is Paladin's most unusual yet purely useful book of the new year. Gives practical information on collecting large or small numbers of wild game under virtually any circumstances. The methods and traps described by Benson are known only to one Indian tribe and a few oldtimers. Benson's uncle and teacher was a member of this tribe; Benson is an oldtimer now with 40 years of poaching experience behind him. He tells you how to get a deer any time you go hunting for one; how to live off the land, whether in the city or country; gives plans for dozens of ingenious, effective traps, snares, and deadfalls; also plans for permanent concealed traps for small game and fish; lessons on woodcraft and scouting; covers equipment, firearm selection, ammo choices, and more. Presents specific collecting procedures in separate chapters for deer, elk, bear, moose, beaver, mink, muskrat, rabbits, squirrels, geese, ducks, salmon, trout, and many others. Most important, the author explains in detail the principles of entrance, evasion, and exit. Over 30 line drawings clearly show the techniques and devices discussed. **Survival Poaching** gives you the answer to the Washington bureaucrats, desk-bound ecologists, and greedy land-posters who are closing down more and more land to public hunting; but especially useful for survival in times of disaster. 5½ x 8½, hardcover, illus., 250 pp., ISBN 0-87364-183-3.

Available February 15, 1980 **\$12.95**

"... I will continue to choose your company first as I accumulate my survival library."

B.W., Panama

Black Medicine II: WEAPONS AT HAND by N. Mashiro, Ph.D.

Self-defense specialists take note: here is the sequel to N. Mashiro's infamous **Black Medicine: The Dark Art Of Death**. That book revealed the 140 parts of the human body most vulnerable in hand-to-hand combat. **Weapons At Hand** takes the opposite approach. It presents 112 parts of the body that are natural weapons, largely because they are very injury-resistant. Following this is a section radically different from conventional self-defense theory, that lists for you more than 180 deadly makeshift weapons that can save your life in a crisis. The weapons are all improvised from common items. And 50 action photos show the reader exactly how to use the "black medicine" techniques discussed in **Weapons At Hand**. Especially suited to the needs of bodyguards, security personnel, and martial artists. 5½ x 8½, softcover, illus., 88 pp., ISBN 0-87364-168-x. **\$8.00**

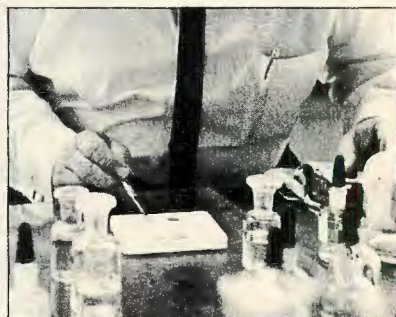

FBI HANDBOOK OF FORENSIC SCIENCE

Hundreds of hardened criminals are released from jail each year because of botched evidence processing. This authoritative FBI manual gives you the information you need to properly gather, preserve, and submit evidence. The **FBI Handbook Of Forensic Science** is an indispensable guide for the police officer, private investigator, or student of criminology. Covers: latent fingerprints, serology, microscopic analysis, toolmark identification, bomb scene searches, law enforcement photography, metallurgy, glass fractures, and much more. Contains a 10-page chart to be used in submitting evidence to FBI laboratories. This handbook provides the investigative-edge that can mean the difference between a successful conviction and an unnecessary acquittal. A definite career booster. 8 x 10, 133 pp., softcover. **\$10.00**

**GETTING EVEN:
THE COMPLETE BOOK
OF DIRTY TRICKS**
by "George Hayduke"

The latest word in do-it-yourself "justice" for everyman makes the other harassment books look like a Sunday school picnic. **The Complete Book of Dirty Tricks** teaches you how to get even whether wronged by an enemy, victimized by a credit card company, or just ripped off by any number of obnoxious individuals and menacing organizations. The methods range from simple pranks to sophisticated techniques of devastation. "George Hayduke" is a master of revenge whose wisdom will help put you on top of any situation where you formerly felt helpless. The book is brimming with anecdotes describing ingenious tactics that have been successfully employed by veteran tricksters. For entertainment purposes only! 5½ x 8½, hardcover, 190 pp. **\$9.95**

Available February 15, 1980

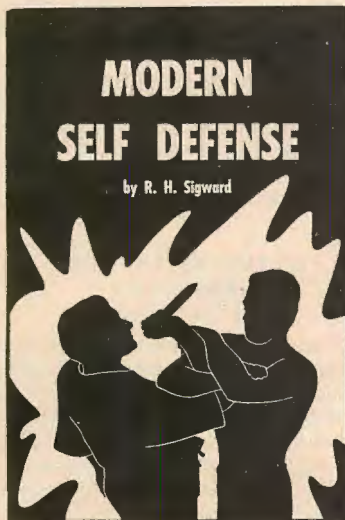

MODERN SELF-DEFENSE
by R. H. Sigward

After a bit of detective work, Paladin was able to locate a limited number of these excellent self-defense texts. Originally published by **Law And Order Magazine**, this book helped train hundreds of law enforcement agents the world over in the art of unarmed self defense/offense. It is based on the teachings of Prof. Jirgaro Kano, known as the father of modern judo/jiu-jitsu. **Modern Self Defense** is illustrated with hundreds of photos showing every block, fall, hold, trip, choke, and disarming technique imaginable. Many similar books have been published since Sigward's text first appeared two decades ago. But none covers this life-or-death topic any more clearly or completely than does this rare find, available only from Paladin! Softcover, 5½ x 8½, 225 pp., illus. **\$8.00**

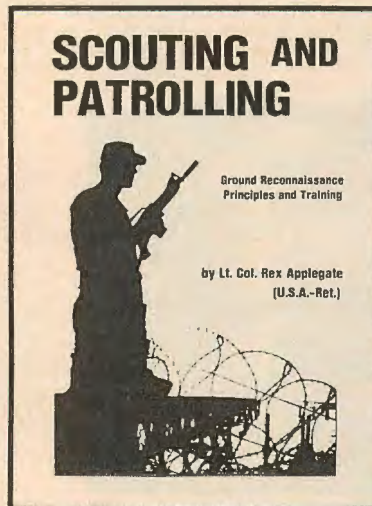

SCOUTING AND PATROLLING
by Col. Rex Applegate

Written by the renowned Col. Applegate, one of the world's acknowledged authorities on police/military tactics and equipment. Originally created and compiled during WW II, **Scouting And Patrolling** was used to train elite Allied troops at Camp Ritchie, Md. Covers scout selection and training; ground observation and appreciation; range estimation and communications principles; siting and operating observation posts; selection and training of patrol members; ambush and recon patrol formations and procedures; lectures on fieldcraft, equipment, jungle patrolling, and Rodgers' Rangers; and a complete training program for the novice scout or patrol member. Also analyzes the scouting and patrolling techniques of the WW II British, German, Italian, and Japanese armies. Training officers and military historians should particularly welcome the addition of this new volume to their libraries. 8½ x 11, hardcover, 135 pp., 80 illus., ISBN 0-87364-184-1. **\$12.95**
Available February 1, 1980

**TAKE MY GUN -
IF YOU DARE**
by Morgan Norval

Suggests an entirely new approach for dealing with the volatile gun control issue. Avoids the typical Second Amendment stand, and gives you new ammunition to fight the gun control fanatics with. As the author says, "The action suggested by this book may strike some readers as radical... (but) the action suggested may become the only course left to enable a free society to keep its firearms." Discusses origins and legal aspects of weapons use for self-defense, the registration threat, the BATF conspiracy, and more. Concerned firearm owners should read this book immediately; *tomorrow may be too late!* 5½ x 8½, 104 pp., hardcover. **\$8.95**

NINJA COMBAT METHOD

Ninjutsu, "the art of stealth," is an 800-year-old system of fighting techniques, information gathering, and psychological controls. Made famous by the feared *Ninja* spies and commandoes of feudal Japan, ninjutsu is one of the most all-encompassing arts of self-protection in the world. **Ninja Combat Method** includes taijutsu (unarmed fighting), tsuki and keru (punching and kicking), ken po (blade method), kusari (chain), kuji-kiri (psychic control), and much more. Japanese warlords of old relied on a few black-garbed Ninja to do what would have taken hundreds of armored soldiers to accomplish. This book will broaden your martial arts knowledge, no matter what your fighting art may be. 8½ x 11, 40 pp., illustrated. **N.D. \$6.00**

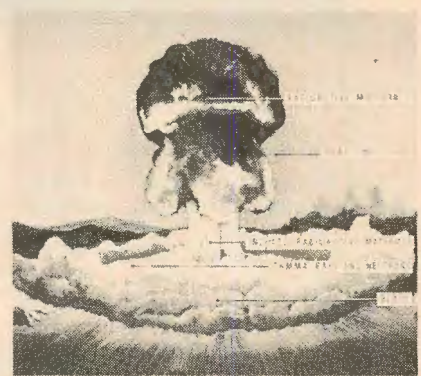

LIFE AFTER DOOMSDAY
by Dr. Bruce Clayton

Who will survive the nuclear war that many experts predict is coming? **Life After Doomsday** tells you how to survive through such a nuclear nightmare. It is an exhaustive investigation of the strategies needed to survive an atomic war, and of the problems that will face those who do live through it. Suggests a step-by-step procedure for creating individual survival plans, including previously uncollected information about shelters, food storage, home medical techniques, and the psychology of survival. The difficult problem of shelter defense is also closely examined. Tells you the prime nuclear target areas in the U.S., as well as those areas least likely to be attacked. Dr. Clayton offers a practical discussion of both the short and long term effects of nuclear weapons' use, and ensuing medical consequences. Explains how to measure fallout radiation, and build an expedient fallout shelter on short notice. One of the most comprehensive and up-to-date works ever compiled on modern survivalism, **Life After Doomsday** is also an excellent reference on surviving through any major disaster. An invaluable addition to your survival library. Includes dozens of useful charts, drawings, and photos. 8½ x 11, hardcover, illus., 200 pp., ISBN 0-87364-175-2. **\$19.95**



Silencers For Hand Firearms
by Siegfried F. Huebner

The first book in English by one of the world's foremost experts. Siegfried Huebner has published numerous books and articles in his native Germany, and to write this book he has drawn from extensive research at the Mauser works, Heckler and Koch, and the German Army Proving Ground to bring to you a complete and authoritative text on silencers. The text covers silencer principles, silencers in World War II, clandestine weapons, and five other vital and intriguing chapters. Over seventy fullsize album pages are devoted to nearly two hundred exciting photos and drawings. Konrad Schreier has technically edited the book to insure its complete accuracy. 8 x 10. 100 pp., 200 illustrations, softcover, ISBN 0-87364-055-1 **\$9.95**

AUTOMATIC & CONCEALABLE FIREARMS DESIGN BOOK, VOL. I

An astonishing collection of automatic and concealable firearms designs. Ten weapons are presented, seven of which are totally improvised. The others involve the modification of common semi-auto rifles (the AR-7 Explorer) to function on full automatic. All drawings are done to scale, and will provide hobbyist gunsmiths and machinists with a wealth of insights into the improvisation and modification of similar firearms. Designs include: AR-7 conversion; Squires-Bingham .22 conversion; .22 Silenced Weapon System; Stinger; Mini-Shotgun Pistol; and five others. 8½ x 11, softcover, diagrams; 40 pp., ISBN 0-87354-165-5. **\$12.00**

LIMITED WAR SNIPING
by PETE SENICH

Paladin is pleased to present the most complete pictorial history of modern war sniping ever compiled. **Limited War Sniping** is an extensive study of the development of .50 caliber sniper rifles, sights, silencers, and ammunition dating from the first designs in WW I to the top-of-the-line XM-21 in Vietnam. This book stresses the years of testing, the effects of training, and the vital role that sniping has played in the wars of this century. Well researched, this book is packed with rare military photos that every war history buff will not want to put down. 8½x11, 150 pp., over 140 photos, hardcover **\$15.95**

KILL OR GET KILLED
by Col. Rex Applegate

A classic text detailing methods of self-defense, offensive close combat, combat shooting and techniques of controlling crowds in riot situations. "The desperately serious business of hand to hand fighting, which conforms to no rules of conduct, is set forth in this book." *Police Chiefs News*. "Kill or Get Killed is about as complete a manual on assorted mayhem as you could ask for." *Combat Forces Journal*. Col. Applegate is widely regarded as the father of modern close combat and combat shooting, and **Kill or Get Killed** is considered the basic reference by which all other books on the subject are judged. The book is a must for every serious student and is a perfect addition to the other combat classics offered by Paladin: **Cold Steel, Do or Die, Get Tough and The Complete Book of Knife Fighting**. 5½ x 8½, cloth, 400 pp., illus. ISBN 0-87364-084-5 **\$15.95**

U.S. ARMY SNIPER TRAINING MANUAL

With the help of this "sniper's bible," the famed U.S. Army snipers in Vietnam killed 1187 VC in one five month period alone. Only 1.37 rounds were expended per kill, at an average range of 450 meters! "An excellent source of information for not only target and sniping work, but also helpful to the hunter as it covers camouflage, shooting techniques and positions, correct lead, map and compass reading, and necessary equipment for survival in the field." **GUNS**. 8 x 10, over 100 illustrations, 196 pp., ISBN 0-87364-121 **\$12.95**

SPECIAL FORCES COMBAT FIRING TECHNIQUES
by Sgt. Frank A. Moyer and Robert J. Scroggle

This one-of-a-kind work, compiled by two Army ordinance experts, eliminates the mysteries, misconceptions and myths surrounding the effective use of small arms in combat. This invaluable information was distilled from extensive tests at the home of the Green Berets at Ft. Bragg, N.C., where over 120 weapons were evaluated by some of the most knowledgeable firearms experts in the world! 8 x 11, clothbound, 120 pp., 130 photos, ISBN 0-87364-010-1. **\$12.95**

SILENCERS, SNIPERS & ASSASSINS
by J. David Truby

"Silencers, Snipers & Assassins vividly portrays how silencers, including Sionics units have been effectively used by CIA agents, Special Forces and U.S. Army snipers, Marine snipers, V.C. assassins, Mafia "contract killers" the West German Gehlen Intelligence Bureau and U.S. law enforcement agencies who employ them in a counter-sniper role..."—R.A. Steindler, Firearms Expert. "A fully documented history of the invention, development and use of silencers..."—*Army Magazine*. 214 pp., 200 photos, 8½x11, cloth bound **\$15.95**



THE INTERNATIONAL MAN
by Douglas R. Casey

Are you looking for a new frontier? One without high taxes, unfair laws, and not under the control of big business and government? If so, then **The International Man** is the book you need. This unique reference is a compilation of information pertinent to those interested in finding a "land of the free". The author has researched 159 countries and selected the 48 which offer the most advantages for financial opportunities, adventure, personal freedom, and pleasure. So don't give up hope; order **The International Man**, and begin making plans for a new life. 8½ x 11, clothbound, 133 pp. N.D. \$14.95

HOW TO OPEN LOCKS
(Without Keys or Picks)

This handy manual is the perfect companion to the lock picking books. Covered are the "jimmy," and how to use it; techniques on opening dead-locked latches, automatic deadlocks, square or dead bolts; spreading door jams; and opening file cabinets, desks, letter boxes, and windows. Also included are chain door fasteners and automobile doors and ignitions. \$4.00

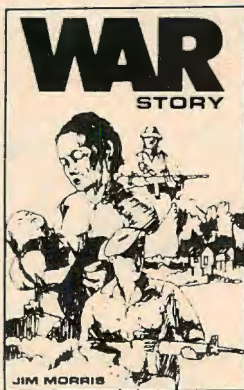

WAR STORY
by Jim Morris

At last, the story of the Vietnam War is told by a former Green Beret as it actually happened, not as reported by the media. The death and devastation, sweltering sun and torrential rains, body counts and atrocities, are all part of **War Story**. Jim Morris loved South Vietnam and its people, and sometimes killed for them. But he also writes about the camaraderie and bravery of his men and Montagnards, and the gentle, verdant landscapes of a country no longer free. **War Story** unfolds dramatically, with the truth and conviction borne of personal involvement with Vietnam and its doomed struggle for freedom. 6 x 9, clothbound, ISBN 0-87364-147-7. \$12.95



RANGER HANDBOOK

Rangers: the name has struck fear in the hearts of America's foes for centuries. From Rodger's Rangers in the Revolutionary War, to the heroic cliff-scaling Rangers at Normandy, through the magnificent long range patrols behind the lines in Korea, the Ranger tradition of bravery and endurance is unmatched. Compiled by the Ranger Department, Ft. Benning, Georgia, this handbook draws from bloody lessons learned from 200 years of special operations combat. Crammed with information on demolitions first aid, boobytraps, rappelling, communications, and over 20 other crucial topics. 4½ x 6, softcover, illustrated, 213 pp., ISBN 0-87364-044-6. \$6.00



TOTAL RESISTANCE
by Major H. von Dach, Swiss Army

"Much of the information given is of considerable tactical interest to the military student, particularly some new slants on booby trapping and the planning and conduct of raids."—**GLOBE & LAUREL — JOURNAL OF THE ROYAL MARINES**. "... highly readable while at the same time being thorough. The illustrations are plentiful, explicit, placed in context and more comprehensive than those found in the U.S. field manuals. The section on demolition and sabotage is unparalleled." —**AIRBORNE QUARTERLY** "... received widespread attention throughout Europe as the most up-to-date manual of guerrilla, resistance and underground operations. Well worth the money." — **MARINE CORPS GAZETTE**. 125 illustrations and photographs, 173 pp., hard cover, ISBN 0-87364-021-7 \$12.95

DETECTIVE'S PRIVATE INVESTIGATION TRAINING MANUAL

by William Patterson

Thousands of detectives were trained by this complete home study text, which was originally published for a well known detective academy. Now you can undertake the same training course for a fraction of its original cost. A fascinating and useful selection, it offers all the inside information and techniques used by the professionals. Covered are such topics as bodyguarding, skip tracing, missing persons, surveillance, disguises, clue gathering, bad check artists, and much more. With the aid of this manual, and four comprehensive tests (also provided), you can quickly qualify to work as a private detective. 8½ x 11, softcover, illus., 160 pp., ISBN 0-87364-161-2. \$12.95

"I have received **what** I ordered, **when** I ordered it, for a **fair** price. I have this terrible feeling that the world is coming to an end... Prompt, correct service? **Egad — frightening!**"

W.B., California

BROWN'S ALCOHOL MOTOR FUEL COOKBOOK
by Michael Brown

Tells you step-by-step how to produce your own alcohol for use in any gas-powered engine. Never be dependent on the foreign oil suppliers again! The author first explains how to build a basic still capable of producing hundreds of gallons of cheap alcohol a day. He then presents simple modification procedures which will adapt your car's engine to burn the alcohol you distill at home. And the author's car gets 100 miles per gallon of alcohol... a very real answer to a very questionable energy shortage. The procedures are adaptable to any gasoline powered engine. 5½ x 8½, softcover, many photos and diagrams, 144 pp. \$9.95

INCENDIARIES, TM 31-201-1

One of the most important areas of unconventional warfare is now covered for the first time in this Army manual. Topics covered in this highly informative book include: Initiators, Igniters, Incendiary Materials, Delay Mechanisms, Spontaneous Combustion, and many more. This book is a must for all firemen, law enforcement officials, insurance investigators and students of pyrotechnics. Supplies are limited. ORDER NOW. 150 pp., over 40 illus., 5x8, soft cover N.D. **\$6.00**

USMC DESTRUCTION BY DEMOLITION, INCENDIARIES AND SABOTAGE

Finally declassified with DOD directive 5200.9, this manual is now made available exclusively by Paladin. This is an exact and complete reproduction of the original terrifying handbook for havoc. No demo library can be complete without this volume. It is a perfect complement to OSS Sabotage and Demolition Manual. 270 pp., 5½x8½, diagrams, photos, soft cover, ISBN 0-87364-004-7, **\$12.95.**

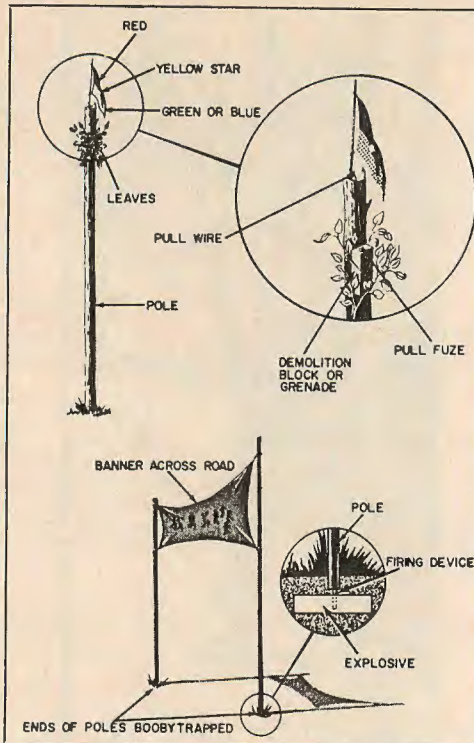

DEAL THE FIRST DEADLY BLOW

Newest available edition! An encyclopedia of unarmed and hand-to-hand combat — not just a complete handbook, but a total training course for the deadly arena where second place is last. This is not a treatise on the gentlemanly art of self-defense. It is a how-to training course for the GI, peace officer or individual who may find himself in a kill or get killed situation, a complete study in how to kill an armed opponent whether you are "armed" with weapons or not. A virtual encyclopedia of gut fighting. The most complete training course in toe-to-toe combat ever put between two covers. 156 pp., 8½x11, soft cover, ISBN 0-87364-126-4. **\$12.95**

SPECIAL FORCES OPERATIONAL TECHNIQUES FM 31-20

In every respect, except for the weatherproof cover and handy pocket size, this is an exact reprint of the famous Army Field Manual 31-20. All illustrations and every one of the 535 pages of vital information are included. Chapters include: intelligence, psych ops, raids and ambushes, communications, demolition, survival, improvised weaponry, and much much more! 4 x 5, softcover, illustrated, 535 pp., ISBN 0-87364-047-0. **\$12.95**

IMPROVED MUNITIONS/BLACK BOOKS, Vol. 1 & 2

These books were originally developed by The Frankford Arsenal for the CIA and Special Forces. They are the most detailed and comprehensive works ever done on the subject of improvised weapons. For years they have been the most sought after and secretive books ever published by the American Military. Only after lengthy and extensive research have we been able to acquire these complete original books and are now making them available to you. Anyone who can foresee the troubled times ahead should not be without the knowledge contained in these books. The originals were small and loose leaf bound because of the limited quantity printed. In republishing we have camera enlarged to 5½ x 8½ in. for ease of reading and perfect bound in a soft black cover. Note: these **Black Books** were known formerly as the **Improved Munitions Handbook**.

Vol. 1, 147 pgs.....**\$9.95**
Vol. 2, 141 pgs.....**\$9.95**

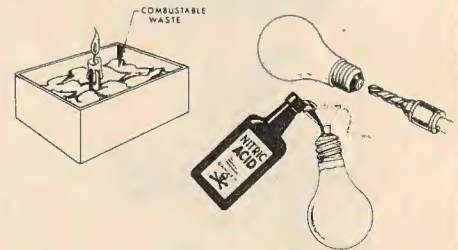

SPECIAL FORCES DEMOLITION TECHNIQUES

Extracted originally for Field Manual 31-20, this pocket-size, fact-crammed book was produced for those interested in the demolition methods used by the elite Special Forces. Just some of the topics covered are: saddle charges, counter-force charges, ribbon charges, and platter charges. A useful addition to any demolition bookshelf. 4¼ x 6¼, illustrated, 67 pp., ISBN 0-87364-082-9. **\$5.00**



UNDERWATER DEMOLITION TEAM MANUAL

Once again available, this formerly restricted Department of the Navy document is the *bible* for the famous Frogmen and SEALs. Profusely illustrated, this text clearly and completely covers the history of UDT, Diving, Demolitions, Survival, Decompression Tables and Weapons. Enjoy page after fact-filled page of vital information with detailed diagrams and drawings for a true understanding of UDT. 225 pp., 8½x11, soft cover, ISBN 0-87364-019-5. **\$9.95**

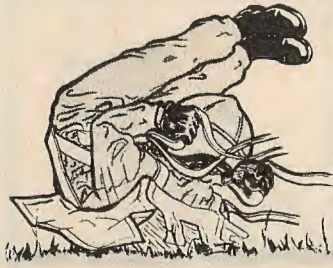

"Your fine selection of books have helped me a great deal as a Marine in training. I'll be ordering more books in the near future. Again, I salute you."
C.H., — California

"I would like to commend you for your instant reply to my last order. Other firms have taken months. I have included with this letter an order and cheque for seven more books."
W.T., Australia

TECHNIQUES OF HARASSMENT
How The Underdog Gets Justice
 by Victor Santoro

Have you, like millions of other citizens, been cheated by the government or big business, only to find yourself legally helpless to do anything about it? If so, this is the book for you. No longer will the large "grey area" of official justice in society trouble you, since it will be easy to take the matter into your own hands. The author describes a virtual encyclopedia of dirty tricks the underdog can use to get even with just about everybody. One might call it guerrilla warfare reduced to the lowest common denominator; where one man can become an army, striking from the shadows, to torment his target without mercy until the score is evened. No legal or moral judgments are made by the author, and readers are warned that **Techniques of Harassment** is for entertainment purposes only. 5½ x 8½, softcover, illus., 80 pp. **\$5.95**

THE COMPLETE BOOK OF KNIFE FIGHTING
 by William L. Cassidy

An exciting book by one of the world's foremost edged weapons experts, William L. Cassidy — executive editor of *Knife Digest*, and former editor of *American Blade Magazine*. Every facet of knife fighting is covered — techniques, tools, and tactics. Also included is a complete review of techniques developed by experts like Fairbairn, Biddle, Applegate and Styers and other never-before published rare information on Oriental techniques. 6 x 9, cloth bound, 130 pp., 90 photographs. ISBN 0-87364-029-2.

\$10.95

PATROLLING AND TRACKING

Published originally by Australian Military Forces. A compact, knowledge-crammed manual developed by the famed "Aussies" from their combat experiences in Korea, Malaysia, and Vietnam! 104 pp., 4x6, soft cover **\$4.00**

QUICK OR DEAD
 By William L. Cassidy

The most important book on combat handgunning of the decade! William Cassidy, well known as the editor of *Knife Digest* and *The Complete Book of Knife Fighting*, presents in **Quick or Dead** the proven techniques employed by gunfighters throughout history. Emphasized are the secrets of effective close-quarters shooting as perfected by such modern masters of the handgun as Fairbairn, Applegate, Cooper, Askin, Jordan, and Fitzgerald. **Quick or Dead** is the one book vital to the needs of serious handgunners everywhere. 6 x 9, hardcover, 160 pp., illustrated, ISBN 0-87364-148-5. **\$10.95**



DEADLY ENCOUNTER BETWEEN TURKOMAN BANDITS.

COLD STEEL
 by John Styers
 text by Karl Schuon

A classic, originally published by *Leatherneck Magazine*. Paladin has obtained exclusive reprint rights to this book, which was the Marine Bible of unarmed combat. Emphasizing the practical aspect of bayonet, knife and stick fighting, **COLD STEEL** also provides short courses in unarmed combat and knife throwing. This rare volume is a must addition to any personal defense, knife fighter's or collector's library. 5½ x 8½, hardbound, 180 pp., profusely illustrated. **\$12.95**

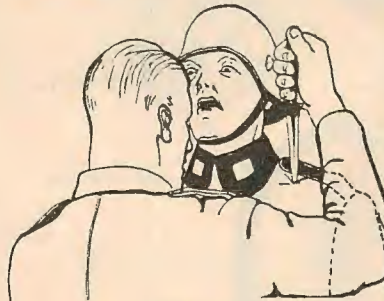

GET TOUGH
 by Captain W.E. Fairbairn

Another Paladin first! This long-out-of print book was used to teach the famed British commandos how to destroy the enemy with bare hands. Fairbairn, who also invented the famous Fairbairn Commando Knife, organized and led the feared Shanghai Riot Squad which suppressed the Shanghai thugs and terrorists who had earned the gory reputation of being the most ruthless assassins on the globe. Covers all types of unarmed combat including use of the Fairbairn Commando Knife. It is both a collectors item and a fact-crammed manual that could save your life! 8½x5½, 120 pp., 140 illus., hard bound. ISBN 0-87364-002-0 **\$9.95**

SELECTED EXAMPLES OF POSSIBLE APPROACHES TO ELECTRONIC COMMUNICATIONS INTERCEPTION OPERATIONS

Because of the explicit nature of this government report, the Executive Office of the President wanted it destroyed. Its original purpose was to determine the capability required to target a specific person's or corporation's telephone communications, and intercept such communications. Contents include: "Interception of a Suburban Residential Telephone," "Interception of a Business's Data Communication to a Computer Service," and "Interception of Conversations over the Direct Distance Dialing Network between Two Specific Individuals in Different Cities." 8½ x 11, softcover, 40 pp., ISBN 0-87364-114-0. **\$10.00**

BLACK MEDICINE I
 by N. Mashiro, Ph.D.

This book presents the most thorough and intriguing discussion of the human body's vital points ever to appear in a single volume. Through strikingly realistic photographs and detailed line drawings, Mashiro illustrates over 150 parts of the human body where a minimum amount of force will produce a maximum impact on a person's ability to fight. The study of these final points is integral to all branches of the martial arts, to the military combat specialist, and to everyone concerned with self-defense in a life or death encounter. Buy now, so you will have the knowledge when you need it! ISBN 0-87364-101-9, **\$8.00**

"I'm presently using *Black Medicine* as the standard text in my martial arts studio. . . . The best discussion of the human vital points I've ever seen."
 Dr. K., California

**HOME WORKSHOP GUNS FOR
DEFENSE AND RESISTANCE
VOL. I, THE SUBMACHINE GUN**
by Bill Holmes

First in a series of technically written books that will enable the average man to easily and simply build his own weapon with a minimum of tools, equipment and materials. through building the receiver, breech block, barrel, trigger assembly, stock and pistol grip, sights and magazine manufacture. Heat treatment and finishing are also covered. This vital knowledge is a must for every concerned citizen. 5 1/2 x 8 1/2, soft cover, photos, machine drawings. ISBN 0-87364-085-3 **\$6.00**

**PRINCIPLES OF
PERSONAL DEFENSE**
by Jeff Cooper

In separate chapters, one of the world's leading experts in the deadly art of combat pistol shooting, explains how Alertness, Decisiveness, Ruthlessness, Speed, Aggressiveness, Coolness, Precision and Surprise can save your life when you are faced with a violent confrontation. Your family needs this information as much as you do! 30 pp., 5 1/2 x 8 1/2, soft cover, ISBN 0-87364-001-2, **\$4.00**

**HOME WORKSHOP GUNS FOR
DEFENSE AND RESISTANCE
VOL. II, THE HANDGUN**
by Bill Holmes

The complete home workshop guide to making your own handgun. Offered are two complete firearms designs, one for a semi or full automatic pistol, the other for a single shot, falling block handgun. As with the first volume in this series, the author has written in a clear, simple style. In addition to explaining how each part and section of the guns are made, the subjects of heat treatment and bluing are discussed thoroughly. Holmes emphasizes the use of improvised materials and suggests many alternative workshop gunsmithing tips. 5 1/2 x 8 1/2, softcover, photos and diagrams, 144 pp., ISBN 0-87364-154-x. **\$6.00**

- TM 9-1005-211-12
Pistol, Caliber .45, Automatic **\$3.00**
- TM 9-1005-223-35
Rifle, 7.62-MM: M14, W/E **\$3.00**
Rifle, 7.62-MM: M14A1, W/E **\$3.00**
- TM 9-1005-210-12
Carbine, Caliber .30:M1, W/E **\$3.00**
Carbine, Caliber .30:M2, W/E **\$3.00**
- TM 9-1005-205-12
Rifle, Caliber .30, M1903A4 **\$3.00**
Sniper's, W/E **\$3.00**

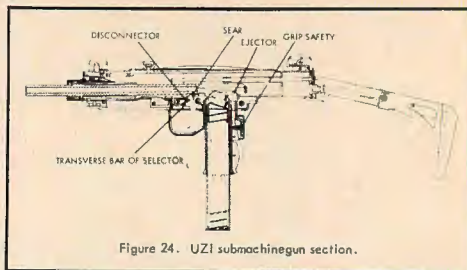

Figure 24. UZI submachinegun section.

**SMALL ARMS AMMUNITION
IDENTIFICATION GUIDE**

Identifies all types of international small arms ammunition up to 14.5 mm on the basis of shape, size, and markings. A useful reference for cartridge collectors, law enforcement personnel and weapons buffs. This is the latest available edition of this manual, and was produced by the U.S. Army Foreign Science & Technology Center. Contains over 100 pages more than previous editions. 5 1/2 x 8 1/2, softcover, illus., 250 pp., ISBN 0-87364-04504. **\$8.00**

THE S.W.A.T. TEAM MANUAL
by Capt. Robert Cappel

Another Paladin first! Captain Cappel's book is the first SWAT team manual ever published. It is the same manual written by the author for use in teaching SWAT methods to various police forces. Formerly restricted to official police use only, it covers the theories, tactics, and training techniques as practiced by a first-rate SWAT team. Tells all about: choosing team members; organizing 4, 6, and 8 man teams; equipment selection; training regimens; principles of counter-guerrilla ops; counter-sniping ops; ambush and counter-ambush techniques; hostage negotiations, and much more. Over 100 illustrations and diagrams outlining SWAT team tactics are also provided. 8 1/2 x 11, softcover, illus., 150 pp., ISBN 0-87364-169-8. **\$10.00**

**POLICE TACTICS IN
ARMED OPERATIONS**
by Supt. Colin Greenwood

To give police and legally armed citizens a definite advantage in armed conflicts, Supt. Colin Greenwood has written this life-saving manual. The author is known as one of Britain's finest police superintendents. He draws from years of experience, and explains specific tactics used to subdue armed criminals in diverse life-and-death situations. Loaded with no-nonsense advice, this book is suited both to the needs of police and private armed citizens as well. Covers weapons and equipment, training, team theory and organization, etc. 8 1/2 x 11, hardcover, many photos and diagrams, 320 pp., ISBN 0-87364-166-3. **\$19.95**

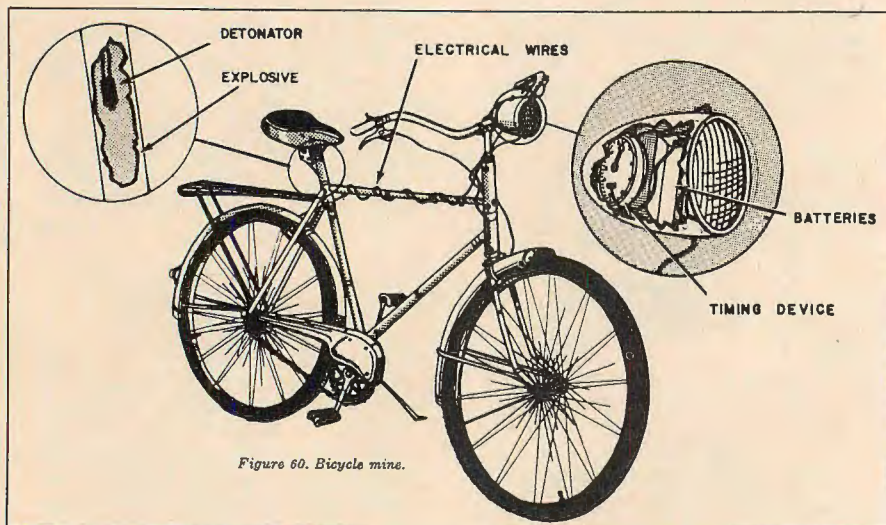

Figure 60. Bicycle mine.

HOW TERRORISTS KILL
by J. David Truby

Police forces and security agencies around the world have ordered this book for their own libraries. It is known as one of the most complete studies of terrorist-employed weaponry yet compiled. Drawing from international sources, the author documents a large variety of weapons currently used by terrorists. Over 80 rare photos accompany the text. Vital reading for students of modern terrorism. 5 1/2 x 8 1/2, softcover, illus., 88 pp., ISBN 0-87364-124-8. **\$6.00**

NEVER SAY DIE

Never Say Die is a detailed study of what to do if... Techniques on how to survive in almost any terrain from desert to the frozen tundra are presented. But unlike other survival manuals, these techniques include valuable information on how to combat fear, pain and PANIC — and win in the struggle against nature. This manual covers everything you need to know in an emergency: finding pure water, medical instructions, photographs of edible natural foods, improvised shelters, tools and equipment, and more. **\$8.00**

HOW TO KILL
by John Minnery

Probably the most terrifying and gruesome book ever printed. Written by a man who KNOWS what he's writing about, the book makes no moral judgments. It merely describes what has been known for years by the professionals who are part of the shadowy world of international intrigue and espionage. As the author states in his preface, "My only premise is that there are times when one must attack with complete ruthlessness and fight with lethal fury. This fury and ruthlessness must be harnessed and directed to do the gravest possible damage—to kill." 5½ x 8½, soft cover, 92 pp., diagrams, photographs. ISBN 0-87364003-9.

\$5.00

HOW TO KILL
Volume Two
by John Minnery

How To Kill, Vol. II, is a fascinating addition to Minnery's controversial first volume explaining the vicious and ingenious methods that assassins have employed through history. Like the first volume, this edition does not advocate killing; rather, it reveals those methods that known, and infamous, assassins have experimented with. The material may shock you, but only because it is true. 5½x8½, illustrated, soft-cover

\$5.00

Note: No volume in the **How To Kill Series** (Volumes I, II, III, & IV) is available in **Canada**, due to legislation by the Canadian Solicitor General.

HOW TO KILL
Vol. III
By John Minnery

Just published, this third **all new** volume in John Minnery's infamous **How To Kill** series is as shockingly informative as its two companion volumes were. Besides documenting ten new "lessons" that professional assassins have employed, the author includes photos and explanations of death-dealing devices developed by the O.S.S., S.O.E., and C.I.A. Such lethal exotica as the Bio-Inoculator, concealed belt firing rig, the killer mike, and the Diefenbaker bomb are presented, many for the first time. Learn the true story behind the recent Bulgarian defector assassinations in London. 5½ x 8½, softcover, 92 pp., ISBN 0-87364-156-6.

\$5.00

HOW TO KILL IV
by John Minnery

Continues from the point where volume three stopped . . . an all new addition to the series called "the most controversial books ever written." Gives little known information on the assassination techniques employed by the K.G.B., C.I.A., O.S.E., etc. Minnery's fourth volume also presents ten new "lessons" outlining novel termination methods inspired by the author's long experience in the security field. Some of the many weapons discussed are the Galitski Projector, the silent shotgun, tranquilizer dart, venom insertion ring, full auto firearm conversions, Soviet Squid pistol, Cannibal throwing knives, etc. Includes dozens of rare photos and diagrams. 5½ x 8½, softcover, illus., 88 pp., ISBN 0-87364-176-0.

\$5.00

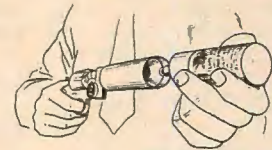

BLACK BAG OWNER'S MANUAL
PART ONE:
"SPOOKCENTRE"

Published for the first time, the *real* inside story of the deadly business of international espionage! **Spookcentre** is part one of a five part series comprising the **Black Bag Owner's Manual**. Written by an anonymous secret agent, this shocking manual exposes the logistical and operational functions of a typical espionage agency. Part one, **Spookcentre**, explains the establishment of one such model organization, and how to make it work for you. 8½ x 11, softcover, 90 pp., ISBN 0-87364-149-3

\$6.00

BLACK BAG OWNER'S MANUAL
PART TWO:
"THE HIT PARADE"

Written by an anonymous secret agent, **The Hit Parade** is a detailed and explicit study of the assassination methodology utilized by secret police and intelligence agencies the world over. The author has separated this deadly business into two categories: overt and covert. Modes of termination covered include projectile weapons, chemicals, edged weapons, germ inoculation, blunt instruments, to name just a few. Also analyzed are agent training responsibilities, infiltration and exfiltration. 8½ x 11, softcover, 100 pp., ISBN 0-87364-157-4.

\$6.00

BLACK BAG OWNER'S MANUAL III:
"FALSE FACE"

Do you need a new identity? One that will withstand close official scrutiny, and enable you to start a new life? If so, **False Face** is the book for the "new" you. Your ID change may entail assuming the identity of some long dead citizen, fabricating an entirely new identity through official channels, or producing "Genuine" identity papers of your own. The author, an anonymous secret agent, offers several alternative ways to approach each aspect of this problem. Packed with practical tips. 8½x11, softcover, 48 pp., ISBN 0-87364-164-7.

\$6.00

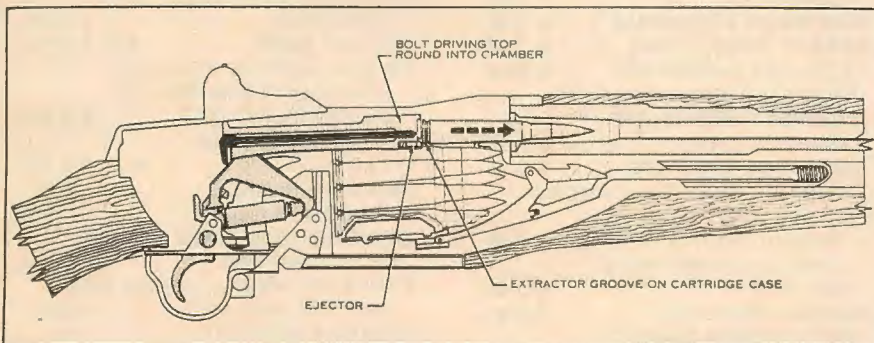

SPECIAL FORCES
HANDBOOK

Paladin Press once again presents the long out-of-print **Special Forces Handbook**. This classic contains chapters on tactics, demolitions, air operations, weapons, communications, first aid, and survival. There are also techniques on unconventional warfare, guerrilla forces' missions, and composition of operational detachments. 4¼x5½, over 200 pp., illustrated, soft-cover.

\$6.00

150 QUESTIONS FOR A GUERRILLA
by General Alberto Bayo

Written by the man who trained Che and Castro in guerilla warfare. "A primer for revolution." **MARINE CORPS GAZETTE**. "A blueprint for mayhem by a professional." **GUNS**. "There can be no doubt that Bayo is an expert in his field of harassing tactics." **GUN WORLD**. Soft cover, 86 pp., illustrated, ISBN 0-87364-022-5.

\$5.00

"The three-part **Black Bag** series . . . written by an anonymous secret agent . . . forms a complete guide to the business of international espionage. Volume One, **Spookcentre**, explains in bold as well as finicky detail exactly how to establish a model spy organization . . . Volume Two, a handbook of political assassination, is punningly titled **The Hit Parade** . . . Volume Three, **False Face**, is a practical guide to forging identity papers, passports — you name it."

Genesis Magazine

SHOTGUNS AND SHOOTING
 HARDCOVER \$ 6.50
 SOFTCOVER \$ 4.00
EXOTIC WEAPONS: AN ACCESS BOOK \$ 6.95
U.S. AND SOVIET TANK KILLERS \$ 5.00
TYPICAL FOREIGN UNCONVENTIONAL WARFARE WEAPONS, FSTC 381-5012 \$ 4.00
SECRET WEAPONS OF THE THIRD REICH \$ 8.95
TM 9-1005-222-35P CALIBER .30 US RIFLES M1, M1C \$ 3.00
TM 9-1005-249-12 TM 05538A-12 RIFLE, 5.56-MM, M16 (USAF) RIFLE, 5.56-MM, M16A1, W/E \$ 3.00
AUTOMATIC RIFLE MARKSMANSHIP \$ 3.50
CLAYMORE \$ 3.00
PRINCIPLES OF SMALL ARMS \$ 4.00
SHOOTOUT—MODERN GUNFIGHTING \$ 5.95
THOMPSON SUBMACHINE GUNS \$ 7.95
U.S. MARINE CORPS HAND TO HAND COMBAT \$ 2.00
HOW TO OPEN HANDCUFFS WITHOUT KEYS \$ 4.95
GUIDE TO GERM WARFARE, TM 3-216 (AFM 355-6) \$ 6.95
HOMEMADE SALUTES \$ 3.95
LAW ENFORCEMENT GUIDE TO FIREARMS SILENCERS \$ 2.95
M1 CARBINE—DESIGN, DEVELOPMENT & PRODUCTION \$24.95
NEW WAYS OF WAR \$ 4.95
NUCLEAR SURVIVAL \$ 5.95
THE M14 RIFLE \$ 4.95
GRENADES AND PYROTECHNICS \$ 5.95
SAFE & VAULT MANUAL \$14.95
FITTING KEYS BY READING LOCKS \$ 4.95
CIA IMPROVISED SABOTAGE DEVICES \$ 8.95
CIA ROCKET ASSISTED GRENADES \$ 4.95
MILITARY SCIENCE FOR REVOLUTIONARIES \$ 4.95
COMBINATION LOCK PRINCIPLES \$ 4.95
TECHNIQUE OF SAFE AND VAULT MANIPULATION ... \$ 9.95
KEYS TO UNDERSTANDING TUBULAR LOCKS \$ 4.95
MASTER KEY LOCKSMITHING VOL. I \$ 4.95
MASTER KEY LOCKSMITHING VOL. II \$ 4.95
HANDCUFFS, U.S. VOL. I ... \$ 4.95
REISING SUBMACHINE GUNS \$ 2.50
AR-15, M-16 AND M-16E1 5.56MM RIFLES \$ 6.95
BROWNING HI-POWER PISTOL \$ 3.95
THE COLT .45 AUTO PISTOL \$ 4.95

DO OR DIE \$ 8.95
SAVE YOUR LIFE DEFENSE HANDBOOK N.D. \$ 5.95
CHINESE PRAYING MANTIS BOXING \$ 4.95
THE QUIET KILLERS: SILENCERS—MYTHS, MYSTIQUES & TRUTH \$ 6.00
THE QUIET KILLERS II: SILENCER UPDATE \$ 6.00
U.S. SILENCER PATENTS 1888-1972 \$29.95
FIREARMS SILENCERS \$ 7.95
NAZI SILENCER PATENTS .. \$ 5.00
PREVENTION OF TERRORISTIC CRIMES \$ 4.00
POLITICAL KIDNAPPING ... \$ 6.00
SNIPING—U.S. MARINE CORPS MANUAL FMFM 1-3B \$10.95

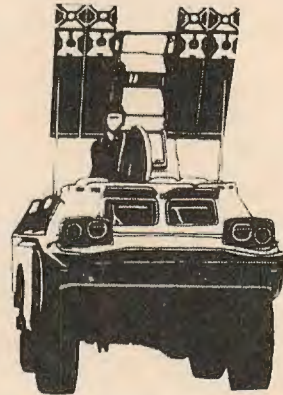

EVASION & ESCAPE \$ 3.95
HAND TO HAND COMBAT .. \$ 3.95
BAYONET FIGHTING \$ 2.00
CAMOUFLAGE \$ 5.95
JUI JITSU DEFENSE AGAINST VIOLENT ASSAULT \$ 2.00
FIRST AID FOR SOLDIERS & SPORTSMEN \$ 4.95
RIOT & DISASTER CONTROL \$ 3.95
SUN, SAND & SURVIVAL ... \$ 2.95
DESERT OPERATIONS \$ 3.95
LECTURES ON SNIPING ... \$ 2.00
UNDERGROUND MANUAL TO COMBAT USE OF THE RIFLE \$ 4.95
LAND MINE WARFARE \$ 3.95
THE BASIC TRAINING HANDBOOK OF THE AMERICAN UNDERGROUND \$ 8.95
GUERRILLA WARFARE: A METHOD \$ 2.95
RANGER TRAINING \$ 3.95
OPERATIONS AGAINST IRREGULAR FORCES \$ 2.95
DEPARTMENT OF THE ARMY TECHNICAL BULLETINS .. \$ 4.00
INTELLIGENCE INTERROGATION HANDBOOK \$ 5.95
HANDBOOK OF BOMB THREAT & SEARCH PROCEDURE .. \$ 4.95
HANDBOOK OF CIA AUTHORITY \$ 2.95
SIX OLD SILENCER CATALOGS \$ 2.95
TRAINING MANUAL TO ADVANCED UNDERGROUND RESISTANCE WARFARE \$ 5.95

.30 CARBINES M1, M1A1, M2 & M3 \$ 6.95
THE AK-47 ASSAULT RIFLE \$ 5.95
GUIDE TO U.S. MACHINEGUNS \$ 5.95
BROWNING AUTOMATIC RIFLE \$ 3.95
WALTHER P-38 PISTOL \$ 4.95
WALTHER MP SUBMACHINE GUN \$ 2.00
PICTORIAL HISTORY OF FIREARMS TO 1905 (U.S. CARTRIDGE CO. COLLECTION) \$ 4.00
SUBMACHINE GUNS .45, M3 & M3A1 \$ 4.95
66MM H.E.A.T. ROCKET \$ 2.00
SWEDISH "K" SUBMACHINE GUN \$ 2.00
EVOLUTION OF MILITARY RIFLES \$ 2.00
SAFN MODEL 49 FN AUKTOMATIC RIFLES \$ 3.50
UZI SUBMACHINE GUN \$ 2.95
GATLING GUN \$ 2.00
COLT AUTOMATIC MACHINE GUN \$ 2.00
BENET-MERCIE MACHINE RIFLE \$ 2.50
BROWNING WATER-COOLED MACHINE GUN \$ 3.00
RIFLE MUSKET, MODEL 1863 \$ 2.00
MAXIM AUTOMATIC MACHINE GUN \$ 2.00
VICKERS MACHINE GUN ... \$ 2.00
INSTRUCTOR'S SPEICAL FORCES DEMOLITIONS TRAINING HANDBOOK \$ 8.95
BRITISH TEXTBOOK OF EXPLOSIVES \$ 2.00
DEMOLITION MATERIALS ... \$ 4.95
INTRODUCTORY GUIDE TO EXPLOSIVES, HANDLING AND DEVICES \$ 3.00
THE BASIC MANUAL OF KNIFE FIGHTING \$ 4.00
BLOODY IRON N.D. \$12.95
AN EVALUATION OF POLICE HANDGUN AMMUNITION: SUMMARY REPORT \$ 4.00
POLICE DEFENSIVE TACTICS N.D. \$ 6.95
BASIC CRIMINAL INVESTIGATION \$ 4.00
DEVIL DOGS; ATTACK & GUARD DOG TRAINING \$ 4.95
STREETFIGHTING: AMERICA'S MARTIAL ART \$12.95
COMBAT WITHOUT WEAPONS \$ 3.00
BELOW THE BELT \$12.95
PERSONAL DEFENSE ... N.D. \$ 8.95
AMERICAN ENGINEER EXPLOSIVES IN WORLD WAR I \$ 2.95
MILITARY EXPLOSIVES \$ 6.95
GUIDE TO VIET CONG BOOBYTRAPS & EXPLOSIVE DEVICES \$ 3.95
ROYAL ENGINEER'S DEMOLITIONS HANDBOOK \$ 3.95
EXPLOSIVES AND DEMOLITIONS \$ 2.50

EXPLOSIVES AND DEMOLITIONS,
FM-5-25, MAY 1967 \$ 8.00

CIA FIELD EXPEDIENT
PREPARATION OF BLACK
POWDERS \$ 4.95

CIA AMMUNITION AND EXPLOSIVE
SUPPLY CATALOG \$ 7.95

COMBAT FLAME OPERATIONS,
FM-20-33 \$ 3.50

PHYSICAL SECURITY,
FM 19-30 \$10.00

THE PYROTECHNIST'S TREASURY;
THE COMPLETE ART OF
FIREWORK MAKING \$ 9.95

OSS SABOTAGE & DEMOLITION
MANUAL \$12.95

BOOBYTRAPS, FM 5-13 \$ 5.00

HI-LOW BOOM N.D. \$ 5.00

THE CHEMISTRY OF POWDER
& EXPLOSIVES N.D. \$10.00

CIA EXPLOSIVES FOR
SABOTAGE \$ 5.95

UNCONVENTIONAL WARFARE
DEVICES AND TECHNIQUES,
TM 31-200-1 N.D. \$10.00

IMPROVISED MUNITIONS
SYSTEMS \$ 5.00

ELEMENTS OF EXPLOSIVES
PRODUCTION \$ 4.00

CIA METHODS FOR EXPLOSIVES
PREPARATION \$ 4.95

MANUAL OF EXPLOSIVES,
MILITARY PYROTECHNICS,
AND CHEMICAL
WARFARE AGENTS \$ 7.00

EXPLOSIVE TRAINS \$ 8.00

THE SURVIVOR I, II, III, & IV
EACH VOLUME \$10.00
FOUR VOLUME SET \$40.00

SURVIVAL GUNS N.D. \$ 8.95

MANTRACKING N.D. \$ 8.95

MEDICAL ADVISOR'S
HANDBOOK \$ 6.00

BASIC COLD WEATHER
MANUAL \$ 8.00

AFOOT IN THE DESERT \$ 4.00

SURVIVAL! \$ 6.00

ALIVE IN THE DESERT: THE
COMPLETE GUIDE FOR
DESERT RECREATION AND
SURVIVAL \$ 7.00

FINANCIAL AND PHYSICAL
SURVIVAL (IN TIMES OF
INFLATION, DEPRESSION,
AND OTHER CRISES) \$12.95

HANDBOOK FOR THE IRISH
REPUBLICAN ARMY \$ 3.00

MINI-MANUAL FOR THE URBAN
GUERRILLA \$ 3.00

COMMUNIST INTERROGATION,
INDOCTRINATION AND
EXPLOITATION OF PRISONERS
OF WAR \$ 4.00

FIELD CRAFT, SNIPING, &
INTELLIGENCE \$ 8.00

INSURGENCY AS A STRATEGIC
PROBLEM \$ 4.00

ADVISOR HANDBOOK FOR
COUNTERINSURGENCY,
FM 31-73 \$ 5.00

U.S. ARMY GUERRILLA WARFARE,
FM 31-21 N.D. \$ 7.50

COUNTERGUERRILLA
OPERATIONS, FM 31-6 \$ 8.00

HANDBOOK ON ANTI-MAU MAU
OPERATIONS \$ 8.00

GUERRILLA WARFARE \$ 5.00

HOW TO BE A GOOD
COMMUNIST \$ 4.00

WE SHALL FIGHT IN THE
STREET \$ 5.00

AMBUSH AND COUNTER
AMBUSH \$ 4.00

999 SURVIVED \$ 2.95



COMBAT IN FORTIFIED AND
BUILT-UP AREAS,
FM 31-50 \$ 4.00

JUNGLE OPERATIONS,
FM 31-35 \$ 8.00

MAP READING, FM 21-26 \$ 6.00

WAR DOGS, FM 10-396 \$ 6.00

BORDER SECURITY,
FM 31-55 \$ 7.00

COMBAT IN RUSSIAN FORESTS
AND SWAMPS \$ 3.00

HITS COUNT! \$ 5.00

WOMEN AT WAR: A DEADLY
SPECIES \$ 4.00

COMBAT TRAINING OF THE
INDIVIDUAL SOLDIER AND
PATROLLING \$ 8.00

THE SCOUT \$ 5.00

ENEMY PRISONERS OF WAR
AND CIVILIAN INTERNEES,
FM 19-40 \$ 4.00

REVOLUTIONARY WARFARE IN
THE MIDEAST: THE ISRAELIS
VS. THE FEYADEEN \$ 6.00

KNIFE DIGEST 2ND EDITION
COLLECTOR'S HARDCOVER
EDITION \$15.00
SOFTCOVER \$ 7.95

SHOOTING TO LIVE \$ 5.95

SNIPING \$ 4.00

BRITISH ARMY SNIPER
MANUAL \$ 6.00

COUNTER SNIPER GUIDE... \$ 4.00

SNIPING IN FRANCE \$ 6.00

PRINCIPLES OF QUICK
KILL \$ 6.00

BEHAVIOR
MODIFICATION \$ 8.00

CIA SPECIAL WEAPONS
SUPPLY CATALOG \$ 5.95

OSS SPECIAL WEAPONS
CATALOG \$ 7.95

POLICE GUIDE TO LOCK PICKING
AND IMPROVISED LOCK
PICKS \$ 4.95

ASSASSINATION: THEORY AND
PRACTICE \$ 8.00

LOCKOUT \$ 6.95

THE PLUMBER'S KITCHEN: THE
SECRET STORY OF AMERICAN
SPY WEAPONS \$14.95

SILENCERS! REPORT 1896
HARDCOVER \$13.95
SOFTCOVER \$12.95

SILENCERS: PATTERNS AND
PRINCIPLES VOL. II \$ 9.95

SILENCER PATENTS VOL. III:
EUROPEAN PATENTS
1901-1978 \$15.00

AGENT'S HANDBOOK OF BLACK
BAG OPERATIONS \$ 5.95

INTELLIGENCE INTERROGATIONS,
FM 30-15 \$ 5.00

CIA FLAPS AND SEALS
MANUAL \$ 5.95

HOW TO AVOID ELECTRONIC
EAVESDROPPING AND
PRIVACY INVASION... N.D. \$ 7.95

OSS CIA LOCKS, PICKS AND
CLICKS \$ 5.95

THE POOR MAN'S JAMES
BOND \$10.00

BRAIN WASHING: A SYNTHESIS
OF THE RUSSIAN TEXTBOOK
ON PSYCHOPOLITICS \$ 4.00

HOW TO FIT KEYS BY
IMPRESSIONING \$ 4.95

LOCK PICKING
SIMPLIFIED N.D. \$ 4.95

THE LOCK PICK DESIGN
MANUAL \$ 5.00

PAPER TRIP I N.D. \$12.95

PAPER TRIP II N.D. \$14.95

INVOLUNTARY REPOSSESSION
OR IN THE STEAL OF THE
NIGHT N.D. \$10.95

MEN IN SPACE \$19.95

SAVE YOUR LICENSE \$ 8.95

INDIAN JEWELRY FACT AND
FANTASY \$ 6.95

IDEAS IN CONFLICT, LIBERTY
AND COMMUNISM \$ 5.00

TO KEEP AND BEAR ARMS .. \$10.95

IMPROVISED MODIFIED FIREARMS
(TWO VOLUME SET) \$17.95

IMPROVISED WEAPONS OF
THE AMERICAN
UNDERGROUND N.D. \$ 6.95

THE POOR MAN'S
ARMORER \$14.95

THE FIREARMS
DICTIONARY \$ 6.95

ORDERING INFORMATION

UNITED STATES ORDERS

1. Use order form and business reply envelope as provided to facilitate prompt delivery.
2. Minimum order is \$10.00.
3. Postage and handling charge of \$2.00 must accompany each order of books.
4. Enclose payment in full with each order. PLEASE DO NOT SEND CASH! If you do, it is at your own risk. No COD's or open accounts.
5. Shipment dispatched usually within 48 hours of receipt of order; mailed SPECIAL BOOK RATE 4TH CLASS, unless other shipping arrangements are made.

ALL ORDERS OUTSIDE U.S.A.

1. Please pay us with an Air Mail International Postal Money Order (which your post office sends directly to us) and send the completed order form to us with your Money Order serial number noted on it. We also accept bank checks drawn on U.S. banks in U.S. dollars.
2. Minimum order is \$15.00.
3. Postage and handling charge of \$3.00 must accompany each foreign order.
4. Shipments are by parcel post book rates, surface mail, unless other shipping arrangements are made.
5. All wholesale orders must be accompanied with full payment including postage and handling charge.

ORDER FORM

Vol. 10, No. 1

SF3

Use separate envelope, and mail to: PALADIN PRESS, PO BOX 1307, BOULDER, CO., 80306.

Phone (303) 443-7250.

Enclosed is payment of \$_____ in check or money order; or charge to my VISA/BankAmericard,
 Mastercharge, Credit Card No. _____ Date Card Expires _____

Signature _____

N.D. = No discounts on wholesale orders

PLEASE SHIP THE FOLLOWING BOOKS:

Minimum order \$10.00 No COD's.
 Colorado residents add 3% sales tax.
 Note: All prices subject to change without notice.

Title	Price

Title	Price

Attention Readers: Paladin Press welcomes original manuscripts concerning the subjects covered in this catalog. We are also interested in purchasing government field and technical manuals for reprint.

	Sub-total	
	Postage & Handling	
	Total	

Name (please print) _____

Telephone _____

Street _____

City _____

State _____

Zip Code _____

Attention Military Personnel: Please include Home of Record Address.

Sign here if you do not want to receive advertising by mail from companies not affiliated with Paladin Enterprises _____

COMPLETE SATISFACTION GUARANTEED

Paladin Press guarantees - UNCONDITIONALLY - that all books, publications, and items listed in our catalog have been faithfully represented. We stand firmly behind every purchase made! We further guarantee your complete satisfaction regardless of reason! If you are not completely satisfied with your purchase, return it within 10 days and we will refund your money!

WILL THEY FIGHT?

Continued from page 51

corps. "Some of these guys are going to stay in. Why not? In peacetime they've got it made. And the Army is going to promote them, and a few years from now they'll be squad leaders. Come the war, will they tell a man in their squad to get his ass up the trail? They won't be able to."

Another sergeant spoke up: "Discipline needs to be taught in the first few weeks or it can't work. We're an Army full of men who have never been taught discipline."

There was seemingly no end to it. Once the first noncom opened up they all began to speak their minds. Afterward, several asked me not to quote them by name. "We've got enough troubles," said one. When I agreed, their dreadful litany continued: "These recruits don't respect us," said a DI. "They don't fear us, and they don't believe in us. How can we take them into combat?"

In an effort to save money on PCS transfers, and to eliminate most of the needless interruptions that accompany a change of station between BCT and AIT, the Army is experimenting with one-station training. For infantrymen this means 12 straight weeks of instruction in the same unit. There are some obvious advantages to this system, in addition to the money saved. It means the recruit does not have to re-acclimate himself to a new geographic region, acquaint himself with the facilities of a new post or get used to the personality of a new drill instructor. The end-of-basic leave is postponed until after the 12-week course.

There is another side to this as well. Soldiers no longer scream out the Spirit of the Bayonet as they charge across the sawdust in pugil gear. In fact, the bayonet is no longer taught at all. Where once all infantrymen learned the simple mechanics of the 3.5-inch rocket launcher, and fired a few rounds, only a select few in each company learn how to operate the DRAGON, and others the TOW. These gunners do not spend time learning about the M60 machine gun; they need all the time available to learn how to make the sophisticated anti-tank systems work.

But, the hardest part of the compressed 12-week cycle falls upon the drill instructor. Now the trainees get to enjoy KP only once — civilian contractors handle this chore after the first few weeks of the cycle. The NCOs bear the full burden of all the traditional extra duties in addition to their platoon responsibilities. Put that into a training cycle half-again as long as it used to be, and you come up with NCOs that have more than their share of family problems. Divorces are common. Most of the DIs I spoke to admitted that they have a tough time convincing their wives that being a drill instructor is worthwhile.

Today is the day for...
the **JAKAL**

DESCRIPTIVE DATA:

Blade: 5" x 1"; Double Edged, Hand Ground
440c Stainless Steel; Spear Point, Satin Finish

Handle: Black Injection Molded Compound

Sheath: Black Leather w/Nickle Hardware;
Velcro Quickdraw Closure

Adaptability: Classic Clip for Boot/Belt Wear.

Optional Shoulder Rig available.

Weight: 5 oz.

Uses: Optional . . .

Jakal Knife & Sheath . . . \$54.95

Optional Shoulder Rig . . . \$8.50

— Dealer Inquiries Are Invited —



**ARMAMENT SYSTEMS
PRODUCTS, UNLIMITED**

P.O. Box 18595 - SOF
Atlanta, Georgia 30326

COMMANDO™ WATCHBAND

Indestructible Nylon Band with Exclusive
Crystal Cover Strap!



Protects your Watch

Conceals Nighttime Glow

Heavy-Duty, Resin Treated Type 8 Mil-Spec Web, 1-23/32". Sewn with nylon thread. Nearly indestructible and will not rot. Hook-n-Loop closures secure the cover and our unique double-locking wrist band. Will not come off even under stress. Washable. Measure wrist to nearest 1/4" and specify color. Olive, Black, Sage Green, Navy.

Order now, only \$5.50, postpaid.

BRIGADE'S KNIFE POUCH

A fitting accessory for most pocket knives. Made of the same material as our Commando Watchband. Regular size fits most pocket knives and all width belts. Hook-n-Loop protective flap keeps knife safe and ready when you need it. Same color choices.

PCH-ST, only \$3.95

PCH-XL, Extra Large size for Buck size knives and Champion. Specify type. Olive, Black or Tan. Just \$4.95



NYLON PARAPACK COMMANDO WALLET

Made to our specifications. Rugged Parapack or Cordura Nylon Cloth. Durable, Water repellent finish. Rugged, 5 pocket wallet, stows I.D., Credit Cards and Money. Velcro® strip keeps wallet securely closed. Rot resistant, floatable, washable, form fitting and mighty comfortable. Now available in Olive, Black, Red, Brown, Blue and Camouflage. Now \$8.25 postpaid



Order these action products by sending your check or money order to:

Brigade Quartermasters, Ltd.

Box 108-L, Powder Springs, Ga. 30073

Phone Orders: (404) 943-9336

**MONEY BACK
GUARANTEE**

"... THE POWER
TO CLOUD MEN'S
MINDS..."

... or at least make an attacker change his mind!!! Stronger than mace; more effective than tear gas; instantly and completely incapacitates one or a number of attackers. Easily carried, this non-lethal weapon will send a stream of protection into an attacker's face, causing unbearable agony. He will have difficulty breathing, double up, and be wholly incapacitated. You can escape unharmed.



To Order
Send \$9.95 + \$1.00 Postage to:

SHADOW SYSTEMS
P.O. BOX 28222 - SOF
ATLANTA, GA. 30328



Historic Speeches Marches & Battle Songs

Dear Clients and Friends:
Your many inquiries and requests for taped presentations have encouraged us to add a tape cassette section to our list of available items. We now offer 3 categories of taped presentation:

(1) German choir, folk and marching songs and music of the Third Reich era, long acknowledged by experts as an exciting high-point in modern European musical development—inspiring and nourishing food for the Aryan soul.

(2) German-language programs from the World War II era; unique and invaluable documents in living sound. Hear the actual voices of Hitler, Goebbels, Göring and other great men of history as they speak to Germany and to the entire world on such crucial matters as the Versailles Treaty, the unification of Germany and Austria, the Nürnberg Party Rallies, the Polish crisis, the outbreak of World War II and the Battle of Stalingrad. Hear these men of history as they were making history, and hear them without the annoying comments of Allied propagandists. Originally restricted by government agencies to a small group of specially-authorized listeners, Samisdat now makes these vital moments of history available to you.

The originals of these recordings are from 40 to 50 years old and their quality is sometimes reduced by the sound reproduction equipment of the time or by shortwave interference. For this reason we have indicated the quality of each recording with asterisks: ***** = very good; **** = good; *** = satisfactory.

(3) Famous lectures in English and German by the noted author, artist and social commentator, Christof Friedrich, recorded from live interviews, talks and debates broadcast over international radio and TV networks. Mr. Friedrich is noted for his insightful and hard-hitting statements on subjects as apparently diverse as flying saucers, modern art, race, politics and international affairs. Hear him put it all together and listen to his opponents as they lose their composure and begin to rave and rant. An audio treat for knowledgeable thinkers.

All orders must be prepaid by International Money Order in U.S. dollars or in cash. Cash should be sent by registered or certified mail to avoid losses. Please write your order and address clearly and enclose sufficient payment to cover postage. Our cassettes are of three types:

- C-60 (one full hour) U.S. \$6.00 or DM 13.00 + Postage
- C-90 (1-1/2 hours) U.S. \$10.00 or DM 18.00 + Postage
- C-120 (2 full hours) U.S. \$15.00 or DM 28.00 + Postage

Please include U.S. \$1.00 or DM 2.00 per tape cassette for overseas airmail postage

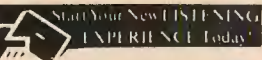

1. MUSIC OF THE THIRD REICH No. 1. (C60***). Horst Wessel Lied. In Dem Kampf um die Heimat. Aus Tiefster Deutscher Not Heraus. Blaue Jungens Marsch. Präsentiermarsch der Kriegsmarine. Luftschutz Lied. Fliegerkameraden. Deutsches Freiheitslied. Junkers 88 Marschlied. Wir Halten Treu Zu Dir. Junkers-Marsch. Hermann Göring Marsch. Heil Hitler Dir. Hakenkreuzfahnen. Die Alte Goldne Abendsonne. Deutschland Lied. Als Fahne Hoch.

2. MUSIC OF THE THIRD REICH No. 2. (C60***). Marsch der Deutschland in Polen. Wir Fahren Gegen England. Marsch der 80,000,000 Wir Kommen Wieder. Gegen Briten und Franzosen. Das Frankreich Lied. Bomben auf England. Ade, Polenland. U.Boot 47. Wir Fliegen Gegen England. Heut' Stechen wir ins Blaue Meer. Ich bin ein Deutscher Matrose. Unser Rommel. Das Deutsche Korps in Afrika. Heil Klingt ein Lied. Vorwärts nach Osten. Der Treu Feldsoldat. So Kämpft nur Unsere Infanterie. Bomben Flieger der Legion Condor. Parade Marsch der Legion Condor.

3. MUSIC OF THE THIRD REICH No. 3. (C60***). Düppeler Schanzens-Sturmarsch. Woihsat Kameraden. Deffiller Marsch. Schwebzbrun auf die Haselnuß. Bayerische Deffillermarsch. Auf der Lunenburger Heide. Regiments-Marsch 55 Das Lieben Bringt Gross Freud. Präsentiermarsch Pappenheimer Marsch. Prinz Eugen. Regimental Marsch. Vom Barreite Schwankt die Feder (Panzer Korps) Deutschland Ruhm. Westwall-Marschlied. Parade-Marsch. Regimental Nummer. Marsch aus der Zeit Friedrichs des Grossen Ein Heiler und ein Batzen Unsere Garde. Die Gedanken Sind Frei. Badenweiler Marsch (Hitlers Favorite)Regimental Nummer. Als die Goldne Abendsonne. In Treue Fest Wir Sind des Geyers Schwarze Haufen. Muss I' Denn Siegler Marsch

GERMAN MUSIC

4. SONGS AND MARCHES OF THE KRIEGSMARINE (C60***) Heut' Geht es an Bord Frisch Voran. Auf Wiedersehen. Mars. Madien. Flaggan auf Vollmast. Ritter der Nordsee. Uns te Marine Winde Wehn. Marine Polka. Print Eugne Marsch. Der Seewind Pfeift. Der Kadettensmarsch. Werte Mein Madel. Ich Denk an Dich. Mein Deutsches Madel. Freundschäftsflage. Lass! Wehen die Fahnen. Scharnhorst Marsch. Heut' Stechen wir ins Blaue Meer. Gneisenau Marsch. Kameraden auf See. Falkland Marsch. Blaue Jung's

5. MARCHES AND SONGS OF THE LUFTWAFFE (C60***) Luftwaffen Parade. Junkers 99 Lied. Aufwärts Zur Sonne. Bomben auf England. Luftpost Voran. Rot Scheint die Sonne. Deutscher Fliegermarsch. Der Bombenfliegermarsch. Graf Zepplin Marsch. Lied der Junkers Flug und Motorenwerke. Prinz Max Brigade. Flieger Empor. Hermann Göring Marsch. Flieger Sind Sieger. Deutscher Adler. Stuka Lied. Pilotenmarsch. Es Blitzen die Stahlernen Schwinger. Flieger Fanfare.

6. WERMARTH (C60***) Victory Fanfare. Weichsel und Warthe. Rosemarie. Gegen Briten und Franzosen. Der Tod in Flandern. Lied der Panzergranadiere. Allen Vorn. Pariser Einzugsmarsch. Sieg Heil. Viktoria Unser Kommal. Wir Stürmen den Sieges engel Von Flandern bis zum Schwarzen Meer. Lied der Panzergruppe Kleist. Der Treu Feldsoldat. So Kämpft nur unsere Infanterie. Deutschland Lied. Lisa-Lisa. Lore-Lore.

7. BATTLE SONGS AND MARCHES OF THE THIRD REICH (C60***) Marsch der Deutschland in Polen. Wir Fahren Gegen England. Bomben auf England. Ade, Polenland. U.Boot 47. Heut' Stechen wir ins blaue Meer. Ich bin ein Deutscher Matrose. Von Finnland bis zum Schwarzen Meer. Der Treu Feldsoldat. Bombenflieger Legion Condor. Heut' Geht es an Bord. Marie Helen Marsch der Leibstandarte Adolph Hitler. Lied der Panzergranadiere. Es Ist so schön Soldat zu sein. Torpedo los! Erika Marsch. Tschingts Bumintara. Gattill di malne grüne Tracht. Mein Schießerland

8. THE REICHSTAG DECLARATION OF WAR (C60***) On September the 1st, 1939, Adolf Hitler gave the world's most famous speech addressed the hurriedly-convened Reichstag and declared war on Poland, giving his reasons for doing so. This speech that plunged the world into the bloodbath of the 2nd World War is translated throughout its entirety by English-speaking commentators of the time without detracting from the Führer's speech, the roars of approval of the Reichstag deputies or the impromptu singing of The Horst Wessel Song.

9. GERMANY CALLING (C60****). William Joyce — Lord Haw-Haw. Traitor or man of vision? Draw your own conclusions after listening to this recording of two speeches made to the British people, one of which is his last speech and draws the attention of the British people that their war against Germany will result in Britain's eventual defeat by Bolshevism. On side two, a song of the period broadcast made by an American who defected to the German side and other German songs of the period.

10. TRIUMPH OF THE WILL (C90***) This is the original soundtrack of the greatest propaganda film of ALL time. It is the most sought after recording that exists and, when you listen to it, you will know why. It records the 6th Party Congress held at Nuremberg. Listen to the enthusiasm of nearly ONE MILLION participants in the 1935 Political Leaders, 88,000 S.A. men, 12,000 S.S. men, 52,000 Labour Service men, 200,000 Hitler Youth/B.D.M., 120,000 Party rank and file, 9,000 additional police for crowd and traffic control... and 350,000 German citizens. Two hours of unbridled enthusiasm, marches, fanfares and speeches by Rudolf Hess, Adolf Wagner, Alfred Rosenberg, Otto Dietrich, Fritz Todt, Fritz Reinhardt, Julius Streicher, Robert Ley, Hans Frank, Joseph Goebbels and of course, Adolf Hitler.

11. STUKA PILOT (C120***). Hans Rudel was Nazi Germany's most decorated air ace of the 2nd World War. In 2,530 operational flights, he destroyed 500 Russian tanks and one Russian battleship. His aircraft (a Stuka) was shot down near Leningrad and it resulted in one of the world's most hair-raising escapes and throughout this 2 hour tape, the listener is held spell-bound by himself and with background music and sound effects added.

12. ADOLF HITLER SPEAKS 1 (C120****). On the 26th of September, 1938, Adolf Hitler spoke to one of the world's biggest rallies at the Berlin Sportsplatz. Speech by Hitler on the Czech crisis. Rally opened by Dr. Joseph Goebbels. Side 2. Conclusion. Singing. marches, etc. PLUS 'Deutschland Erwache', extract from radio broadcast of the ceremony in the Potsdam Garrison Church, 21st March, 1933. Das Horst Wessel Lied.

13. ADOLF HITLER SPEAKS 2 (C120****). Side 1. Adolf Hitler Speech in the German Reichstag, 20th February, 1938. Side 2. Adolf Hitler Part of speech in the Berlin Sportsplatz, 30th January, 1941. (2) Adolf Hitler Complete last broadcast from Uhler Hauptquartier, 30th January, 1945. (3) Songs of the S.A. Der Führer Ruff. S.A. Voran. Erbsen Mit Speck. Flamme Empor. Hymne der Arbeit. Ein Mann — Ein Vort. E. Geht ums Vaterland. Was Uns're Väter Schufen. Kraft Durch Freude. S.A. Sieg Heil.

14. ADOLF HITLER SPEAKS 3 (C120****). A real gem of a recording for content. Side 1: Adolf Hitler addresses a mass rally at the Berlin Sportsplatz on the 10th February, 1933. Side 2: Hitler's speech to the German Reichstag, 23rd March, 1933. (Note: Hitler's speech is preceded by a speech by the leader of the Social Democratic Party (2) Full recording of the ceremony at the funeral of President Von Hindenburg (3) An excellent selection of Nazi songs and marches

15. THE TRUTH ABOUT GERMANY (C120****). Jack Briggs, a young Londoner first visited Germany as part of the forces of occupation in 1919. After demob, he became a frequent visitor to Germany and travelled between the two countries, Britain and Germany, throughout the period of Hitler's rise to power and noted its effects on Germany. Immediately after World War 2 ended, he visited Germany again and for two extremely interesting hours, he gives his impressions of the REAL GERMANY that the Brits Schoon. He has never been told about. Here is an unprejudiced account that will do more than explode a myth or two — for the listener with an open mind.

16. DAS DEUTSCHE VOLKSKONZERT (C60****). Original recordings of popular German Wartime concerts given over the German radio for the German Armed Forces and their families. All the top of the period including the legendary Lale Anderson. A must for the collector of historical material.

17. SONGS OF THE BROWNSHIRTS 1 (C60****). Deutschland, Heiliges Deutschland. Der Führer Ruff. S.A. Voran. Die Welt Gehört den Führenden. Soldaten sind Immer Soldaten. Der Steigermarsch. Erika. Durch Grossberlin Marschieren Wir. Das Hitler-Adler Bataillon. Erbsen mit Speck. Flamme Empor! Die Braunen und Schwarzen Husaren. Hymne der Arbeit. Ein Mann — Ein Vort. E. Geht ums Vaterland. Wenn die S.S. und die S.A. Aufmarschieren. Was Uns're Väter Schufen. Kraft Durch Freude. Hakenkreuzfahnen. S.A. Sieg Heil.

18. SONGS OF THE BROWNSHIRTS 2 (C60****). Deutsche Erliche. Horst Wessel Lied. Flieg. Deutsche Fahne Flieg. S.A. Marschieren. Wir Kämpfen für Ehre und Zillern die Morschen Knochen. Die Deutsche Arbeitsfront Marschieren. Es Pfeift von Allen Dachern Bruder in Zechen und Gruben. Deutschland Voran. Ich Halt' Einen Kameraden. Das Regiment von Hitler. Volk ans Gewehr. Lisa-Lisa. Annemarie wo geht die Reise hin? Die Braune Kompanie. Lore-Lore. Markische Heide. Deutschland Lied.

19. EIN REICH, EIN VOLK, EIN FUHRER (C60****). The Third Reich in sound, films and (extracts from films made during the Third Reich. 20. BLACKSHIRT AND BROWNSHIRT STORM-TROOPER SONGS AND MARCHES. (C90***). A brilliant reproduction of the marches and songs of the Blackshirt and Brownshirt legions of the Third Reich. These include Signal Trumpeter Marsch, Brownshirt Regimental Band Sturm Horst Wessel, Marching in Greater Berlin, Swastika Flag, The Führer calls his Stormtroopers. Esstika in der Heimat of Steet... Band of the Erhardt Brigade who chose Belonging to Hitler — Bodyguard band of Adolf Hitler, Brothers in Factories, Iarme and mines, Hitler Youth Songs. Hall Germany — The Brownshirt Band. The Horst Wessel Song sung by Hitler's bodyguard Leibstandarte. In the East we are now Marching. Gold and Silver. In the Fight for Germany. We Are The Fighters from the N.S.D.A.P. The Golden Evening Sun, plus many others making up a total of one and a half hours of history brought alive with full reproduction brilliance. One of the most popular tapes.

21. REICHARBEITSDIENST. (C120****). Here is a comprehensive recording of ceremonies, songs and speeches surrounding the National Socialist Labor Service. Also included is a very rare excerpt from the 1935 Party Day Rally at Nuremberg. Battle marches include Blinkende Spaten — Heiliges Feuer, Grusset die Fahnen, Gott Segne die Arbeit, Wir Tragen das Vaterland, Es Zillern die Morschen Knochen and many more. PLUS a rare recording of actual combat made aboard a German U-boat as it engages a British armed merchant ship.

22. DIE HITLER JUGEND (C60****). Major speeches and ovals of the Hitler Youth Rallies, songs and speeches by Hitler, Baldur von Schirach, etc. A thoroughly interesting recording that shouldn't be missed.

23. DER ZWEITE WELTKRIEG. Documentary recording of original Hitler war speeches, films, songs, Ribbentrop, Goebbels, radio, etc (C60****).

24. DAS DRITTE REICH (THE THIRD REICH) (C60****). Major speeches, Hitler, Goebbels, etc, events, broadcasts, rallies during the 3rd Reich 25. JOSEPH GOEBBELS/HERMANN GÖRING. (C60****). Their major speeches during the 3rd Reich era. Side 1. Dr Goebbels Side 2. Hermann Göring

26. PER ITALIA — PER IL DUCE (C60****). Songs and Marches of Fascist Italy. Inno di Garibaldi. Il Testamento. Dove sei Steto. La Campone de S. Giusto. Giovanni Fascisti. Ratanpan Della Vittoria. La Rittirata. Camerata Richard. Battaglioni M. Lilli Marlen. Fiori Alpini. Inno a Roma. Fiacchi il Saeco. Fighi Della Lupu. La Leggenda del Pieve. O Dio del Cielo. La Penna Nera. Ti Saluto vado in Abissinia. Canto della Vittoria. Reggimento San Marco. Ciso Blondina. Giovinetta.

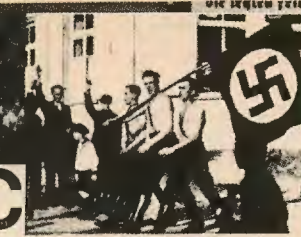

28. BEAUTIFUL NAZI MARCHES AND SONGS No. 1 (C90****). Side 1. Badenweiler Marsch. Musikkorps S.S. Standarte 42. Flensburg. Deutschland Erwache. S.A. Standarte XII. Sturm Horst Wessel 67/5 with choir in dem Kampfe um die Heimat. S.A. Standarte XII. Sturm Horst Wessel 67/5 with choir. Durch Gross Berlin. Marschieren wir S.S. Sturmabn XII Untergruppe Ost Berlin. Märkische Heide. Wir Sind das Heer vom Hakenkreuz. S.A. Standarte 1. Maikowsky

29. EXCEPTIONAL NAZI SONGS AND MARCHES. (C90****). Side 1. Vom Barreite Schwank die Feder. Wir Sind des Geyers. Jungvolkmusikzug u. choir. Kleine. Monika. Rosemarie. Reichsmusikzug des RAD. Argonnewald. Musikkorps 3. Batt. 9. Infanterie Regt. With choir. Lig. Berdien Lied einer Kriegesberichter Kompanie:

30. DR. GOEBBELS AND THE THIRD REICH (C90****). Side 1. Wir Tragen den Silbernen Adler am Rock. 2. Dr. Goebbels. His last tragic broadcast to the German people before the fall of the Third Reich to the allies 19th April, 1945. Deutschland Erwache! Aus Tiefster Not (From Dessau Distress). Sieg Heil du Deutsches Vaterland. Das Ostmark Lied. Egerländer Marschlied. Side 2. Dr. Goebbels opens the huge 1932 Rally in the Berlin Sportsplatz. 2. Volk ans Gewehr. (S.S. Standarte 42). Horst Wessel Lied.

31. HITLER AND GOEBBELS SPEAK (C90****). Side 1. Stormtrooper songs. Brüder in Zechen und Gruben (Brothers in Factories and Mines). Flieg, deutsche Fahne, Flieg (Fly German banner, fly). Deutschland Voran (Germany Forward). 2. Day of National Labor (30th April — 1st May 1933). May night of Hitler Youth and League of German Girls in the Rostfrappe and Hexentanzplatz, Harz. Speech by the Hitler Youth Leader, Baldur von Schirach. Songs include: Die Jugend Marschlied, Flamme Empor, Vom Barreite schwang die Feder Song of the Panzer Korps). Wir sind das Heer vom Hakenkreuz (We are the Army of the Swastika).

33. A GERMAN DEBATES THE ARAB-ISRAELI DISPUTE! (C120****). Listen to this blow-by-blow replay of the most incredible talkshow ever broadcast in Canada. The presentation culminates in a telephone call which was broadcast over the air advocating the murder of Christof Friedrich!

36. ANTI-GERMAN PROPAGANDA (C120****). Radio and TV appearances by Christof Friedrich in defense of truth and justice regarding the current campaign of slander and vilification which is being directed against Germans and Germany in the media of information, entertainment and education. Christof Friedrich exposes the hater's

37. GERMAN-JEWISH DIALOG (C120****). Christof Friedrich interviews Benjamin Freedman the brilliant Jewish scholar and convert to Christianity who reveals for the first time to the world his secret meetings with President John F. Kennedy and General Douglas MacArthur regarding the Jewish Question. Learn from a key behind-the-scenes participant how, when and where the Rothschilds swindled America into World War II!

All orders must be prepaid by International Money Order in U.S. dollars or in cash. Cash should be sent by registered or certified mail to avoid losses. Please write your order and address clearly and enclose sufficient payment to cover postage. Our cassettes are of three types:

- C-60 (one full hour) U.S. \$6.00 or DM 13.00 + Postage.
- C-90 (1-1/2 hours) U.S. \$10.00 or DM 18.00 + Postage
- C-120 (2 full hours) U.S. \$15.00 or DM 28.00 + Postage

Please include U.S. \$1.00 or DM 2.00 per tape cassette for overseas airmail postage

Dealer inquiries invited. Please send me the cassette

tapes I have checked off

<input type="checkbox"/>	<input type="checkbox"/>	<input type="checkbox"/>	<input type="checkbox"/>	<input type="checkbox"/>	<input type="checkbox"/>	<input type="checkbox"/>	<input type="checkbox"/>
<input type="checkbox"/>	<input type="checkbox"/>	<input type="checkbox"/>	<input type="checkbox"/>	<input type="checkbox"/>	<input type="checkbox"/>	<input type="checkbox"/>	<input type="checkbox"/>
<input type="checkbox"/>	<input type="checkbox"/>	<input type="checkbox"/>	<input type="checkbox"/>	<input type="checkbox"/>	<input type="checkbox"/>	<input type="checkbox"/>	<input type="checkbox"/>
<input type="checkbox"/>	<input type="checkbox"/>	<input type="checkbox"/>	<input type="checkbox"/>	<input type="checkbox"/>	<input type="checkbox"/>	<input type="checkbox"/>	<input type="checkbox"/>
<input type="checkbox"/>	<input type="checkbox"/>	<input type="checkbox"/>	<input type="checkbox"/>	<input type="checkbox"/>	<input type="checkbox"/>	<input type="checkbox"/>	<input type="checkbox"/>
<input type="checkbox"/>	<input type="checkbox"/>	<input type="checkbox"/>	<input type="checkbox"/>	<input type="checkbox"/>	<input type="checkbox"/>	<input type="checkbox"/>	<input type="checkbox"/>
<input type="checkbox"/>	<input type="checkbox"/>	<input type="checkbox"/>	<input type="checkbox"/>	<input type="checkbox"/>	<input type="checkbox"/>	<input type="checkbox"/>	<input type="checkbox"/>
<input type="checkbox"/>	<input type="checkbox"/>	<input type="checkbox"/>	<input type="checkbox"/>	<input type="checkbox"/>	<input type="checkbox"/>	<input type="checkbox"/>	<input type="checkbox"/>
<input type="checkbox"/>	<input type="checkbox"/>	<input type="checkbox"/>	<input type="checkbox"/>	<input type="checkbox"/>	<input type="checkbox"/>	<input type="checkbox"/>	<input type="checkbox"/>
<input type="checkbox"/>	<input type="checkbox"/>	<input type="checkbox"/>	<input type="checkbox"/>	<input type="checkbox"/>	<input type="checkbox"/>	<input type="checkbox"/>	<input type="checkbox"/>
<input type="checkbox"/>	<input type="checkbox"/>	<input type="checkbox"/>	<input type="checkbox"/>	<input type="checkbox"/>	<input type="checkbox"/>	<input type="checkbox"/>	<input type="checkbox"/>

SEND CHECK OR MONEY ORDER TO:

NAME (PRINT) _____
ADDRESS _____
CITY _____
STATE _____ ZIP _____
AMOUNT ENCLOSED \$ _____

Allow 2-3 weeks for delivery, otherwise add \$4.95 for Air Mail Postage.

For complete details, SOLDIER OF FORTUNE APRIL/97 from page 19
NAZI SECRET WEAPONS ART POSTERS \$2.00 each
These military artists' depictions of actual German Secret Weapons are taken directly from the original blueprints, enhanced by showing them in combat action situations. Each illustration is complete and is printed upon high-quality paper, suitable for framing. + \$2.00 per order to cover postage and handling.



ORDER FROM: SAMISDAT, 206 Carlton St., Toronto, Ontario, Canada M5A 2L1

One DI told me that, given an honorable out, full half the DIs he knew would "get out from under the hat."

ABOUT THE AUTHOR

Marv Wolf, a free-lance writer located in a Los Angeles, Calif., suburb, has held every job there is in an infantry platoon: rifleman, machinegunner, grenadier, mortarman, squad leader and platoon sergeant. In 1961 he was a drill instructor at Fort Jackson, S.C., and his enlistment was extended at that time because of the Berlin crisis. Wolf left the Army in 1962 after serving on the Ranger Combat Conditioning Committee at Fort Benning. He reenlisted in 1965 when Vietnam began heating up and was immediately assigned to the First Cavalry Division (Airmobile) where he somehow wound up as a Spec. 4 in the Public Information Office shop — which meant that he dealt with the war correspondents in 'Nam.

I first met him shortly after the Cav's advance party hit An Khe in '65. AP photographer Henri Huett and I sprinted out of a Caribou toward a small cluster of men digging furiously at a large foxhole. Two of them were Wolf and a captain named J.D. Coleman.

A sniper shot cracked out, we all ducked and I said, "Hi, I'm Bob Poos of the Associated Press. This is Henri Huett, AP photographer."

Coleman said: "I don't really give a fuck who you are. Grab a shovel and start digging if you want to live out the rest of the day."

Wolf echoed, "Yeah, man, dig, dig. Mortared us all last night."

Thus inspired Huett and I did start digging as fast as the others. Good thing. They mortared us that night too. Wolf and I have been firm friends ever since.

Bob Poos
Managing Editor

To find out how the trainees see their training, I spent several hours daily for five days with one platoon. It may not have been the best platoon to go through the Benning program, but it was far from the worst. Most of the men were 18 or 19. The oldest was 26, Pvt. Sam Ferguson, a cheerful man who boasted of his motorcycle gang membership back home in Pittsburgh, and pulled up his shirt to show a dozen livid scars crisscrossing his stomach and chest. They were not the sort that come from a surgeon's skillful hands.

"It's kind of fun," he shrugs. "They're not pushin' us as hard as they could. Maybe I should have joined the Marines," he adds, as his squad jeers and guffaws.

Bianchi Wrote the Book

"BLUE STEEL & GUNLEATHER is a book long overdue, written by the one man whose studies have made him the logical person to write it... If you are interested in gunleather, it would be very bad judgment not to own this book. Buy it and study it. Then do what it says!"

Bill Jordan

"This book is long overdue. There has never before been a text devoted entirely to gunleather... It is all here, inextricably entwined in a fascinating study of major proportions, written by a man who in my humble opinion is our foremost authority. I commend it to you."

Colonel Charles Askins
THE AMERICAN RIFLEMAN

"The peace officer, quick-draw artist, and hunter will appreciate this book which fully covers all needs and illustrates them clearly. I can highly recommend this fine book to all the gun-toting fraternity."

Elmer Keith
GUNS & AMMO Magazine

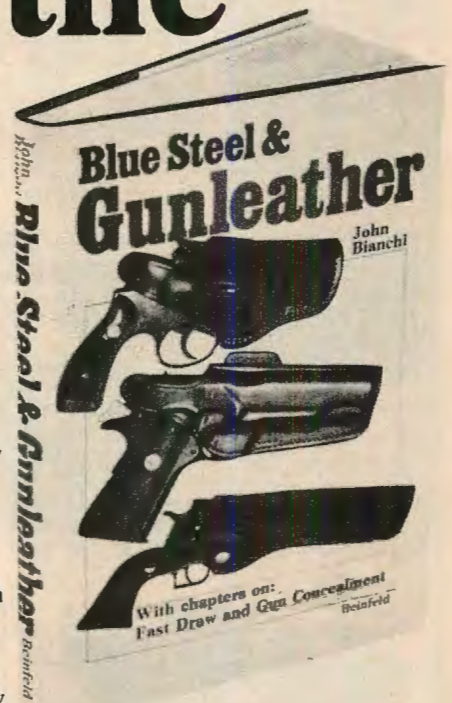

"John Bianchi and I have been old friends since the Dark Ages, and now that John has found time to assemble and publish "Blue Steel & Gunleather" he speaks as the patron of the largest and most sophisticated gunleather operation in the world... Attend his words. You will be glad therefore."

Jeff Cooper
International Firearms Authority

"There's a lot more to holsters than you'd think, and this book tells it all."

Dean Grennell
Managing Editor
GUN WORLD Magazine

A BEINFELD BOOK

I ENCLOSE \$ _____ FOR _____ COPY(S) OF BLUE STEEL & GUNLEATHER AT \$9.95 EA.

NAME (PRINT) _____

ADDRESS _____

CITY _____

STATE _____ ZIP _____

Send Check or Money Order To:
SOLDIER OF FORTUNE

P.O. Box 693, Dept. BB, Boulder, Colorado 80306

Please add \$1.00 per book for postage & handling Colorado residents add 3% sales tax

PHOENIX



A.



B.

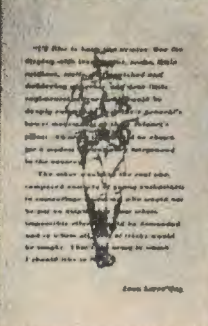

C.

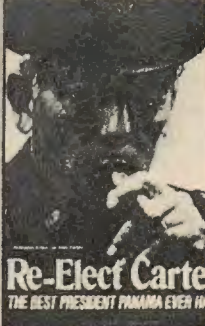

D.

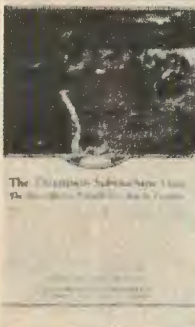

E.



F.

POSTERS FROM PHOENIX ASSOCIATES

Large top quality wall posters that show your true feelings. They are a must for men of adventure. Decorate your den, bedroom, workshop, or your friendly local store window.

ONLY
\$2.95
Each

SF-12
Add \$1.00
Postage
and Handling
Per Order

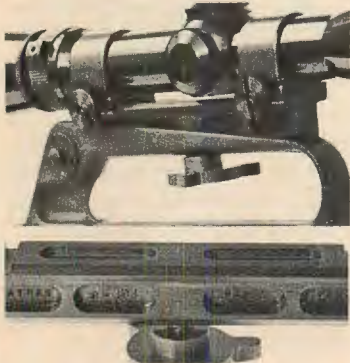

M16 SCOPE MT SF-22—\$8.95



"RHODESIAN" AMMO POUCH
\$22.50

Five Velcro tipped pockets take 30 rd AR/15, 20 rd FN or M-14 mags. Plus \$1.25 postage & handling. Dept. SF-25

AIRFORCE
SURVIVAL
KNIFE
\$12.50
SF-9



MARINE
COMBAT
KNIFE
\$16.95
SF-10



WW I TRENCH
KNIFE \$16.95
SF-14

COMMANDO
KNIFE \$16.95
SF-11



LIFETOOL \$14.95
SF-17

VISA
Mastercharge
Overseas Orders add 20%
Colo. Residents add 3%

P.O. Box 693
Dept. SF778
Boulder, CO 80306



But most of the men I spoke to agreed that they weren't being stressed. One volunteered that he understood why the sergeants sometimes dropped them for pushups. "They're trying to make things tough on us so that if we go into combat we'll feel more confident," he said.

It was an observation that would not have occurred to any of the men in my 1959 platoon. But none of the trainees I spoke to would admit to having doubts about their ability to complete the program, or to having been to anywhere near their physical or mental limits.

Partly this is the simple bravado of the young. ("Was it tough, son? Did they really give you a hard time?" my father asked in 1959. "Naw, it wasn't so tough — I could take it," I answered. I elaborated on this theme for my girlfriend.) So maybe the soldier himself will never admit that it was tough. One point is clear. The soldiers that come through Ft. Benning now are in better physical shape than any that have come before them. They get their daily hour of PT, rain or shine, no matter what else is on the training schedule. They march longer, harder and faster than did the recruits of my generation.

To show me the big picture, Col. Van Meter's exec set up the brigade conference room, complete with two-projector, rear-screen slide show. Lt. Col. Francke trotted out reams of statistics, endless charts and graphs. He compared the present recruit with his WWII counterpart. It is a familiar and convenient reference, for nearly every able-bodied male in the nation served during that war, whereas nowadays most of the recruits seem to be from the lower half of the socio-economic American pie. A more realistic comparison might be with the G.I. of 10 or 20 years ago; these figures were not forthcoming from anyone at Ft. Benning.

Francke recounted the various studies that have been going on more or less continuously for the last 30 years. Weapons have changed, the soldier has changed, the national priorities have changed. The training process has been studied and restudied to measure aptitudes for combat skills, physical conditioning, rifle marksmanship — Col. Van Meter, self-proclaimed revolutionary, would like to bring back known-distance marksmanship training — the number of hours devoted to this subject and to that.

(Although Van Meter calls himself a "revolutionary," he is really a reactionary. His desire to return to known-distance bullseye rifle shooting, for example, something the Army had done since the American Revolution, and something the Marine Corps has never abandoned. The Army gave it up in 1959. Van Meter says simply, "A man knows a lot more about his shooting ability when he can see how well he has placed a group of aimed

Continued on page 84

COMBAT PISTOLCRAFT

Continued from page 11

An expert has no need for a device to keep his index finger straight while drawing, but the novice does and I have known accidents to result from its absence.

Q. I would like to purchase a Model 1911 Government pistol in stainless steel. Which pistol — AMJ, Crown City or the Vega — is best for reliability, accuracy and durability?

Where can I purchase a copy of your book, *Cooper on Handguns*? I have tried everywhere with no success to find your book and am kicking myself for not having gotten it when it was available.

R.H.

Dillard, Georgia

A. At present, the quality control procedures used in all of the stainless-steel .45s do not seem to be sufficient to the task. Let us hope this changes, but for the present I cannot recommend any of these pieces.

The original version of *Cooper on Handguns* is long out of print but there is a new one with a black cover that Peterson Publishing Company has just released. Check your local book and gun stores or write Peterson at 40 Sunset Blvd., Los Angeles, CA 90069.

—Jeff Cooper

This month Ken Hackathorn analyzes double-action features of both wheelguns and auto pistols and briefly evaluates the Benelli B76, the Czech 75 and the Beretta M84. He also comments on a new Soviet

weapon, the AKS-74, similar to our 5.56mm rifle.

Certain firearms experts are fond of expounding the virtues of the double-action (DA) autoloading pistol. After the German army adopted the Walther P-38 pistol, many students of weaponcraft thought that the DA auto pistol would be an ideal defensive sidearm. Today most handgun manufacturers offer a DA auto pistol suitable for service use.

In the U.S., Smith & Wesson Model 39/59 series auto pistols are considered top choices. From Europe come the P-38 Walther, Heckler & Koch P-9S, Sig-Sauer 220 (Browning BDA), Beretta M92, Benelli B76, and Czech 75, all of which represent a service-style pistol with self-cocking trigger action.

DA pistol supporters point out that the DA auto is safer to carry and easier to operate due to the single motion of pulling the trigger, and they argue that the DA auto is faster for the first shot. They are reluctant to use single-action (SA) autos, such as the Colt Government Model, in condition one.

Overcoming fear of carrying the single-action auto cocked and locked, however, relates more to training than to weapon design. For those who dislike carrying a condition-one SA pistol, their fear is mostly psychological. Many men — who believe carrying a cocked-and-locked .45 is dangerous — go hunting with their favorite shotgun, be it double-barrel, pump gun, or autoloader, with the hammer cocked and safety on. Since the cocked hammer is out of sight, they seem to

THE HITLER CULT REVEALED

Discovered alive in India:
Hitler's guru!



Read her shocking and most recently published manuscript, "The Lightning & the Sun", which exposes the tangled roots of Nazism for all to see. Discover through her the secret Nazi pyramid connection with Pharaoh Akhnaton and the ancient cult of the sun. Learn the real significance of Genghis Khan's evil role in history, his incredible significance in the present. Discover the hidden springs of Hitler's manic will to power, his mystical bond with the dark forces of time and destiny. Pursue the outlines of evil in its awesome cosmic context.

Decipher now the encoded workings of the Nazi mind. Perceive how Hitler saw the workings of the universe through: Human sacrifice • Vegetarianism • Aryanism • The cyclic view of history • The children of violence • The will to survive and to conquer • The seat of truth • Gods on earth • Kalki, the avenger.

Were ancient sanskrit laws of the universe compiled in the Bhagavad Gita the secret source of Nazi strength? The amazing answers to these riddles are now at hand. Read them in "The Lightning & the Sun". Hitler guru Savitri Devi's huge, illustrated 448 page illumination of occult Nazi wisdom and prophecy. \$15.00 post paid.

5=C-120 Cassettes \$70.00 per set,

For serious students of the occult: You can now purchase the complete set of tape cassette recorded, live interviews with Hitler guru Savitri Devi at her home in India. Hear in her own words the narration of a prophetic pilgrimage along the edge of the cosmic abyss. Watch the clouds of evil scatter under the lightning of Cosmic Justice and the sun of Cosmic Truth.

The complete story of Nazi Germany's Secret Weapon-UFO Program. 160 easy to read pages. Colourful Cover. Large 8 1/2" x 5 1/4" format. 145 Photographs. 74 Engineering Drawings and Illustrations. 5 Maps (showing U.F.O. Bases, etc.) 83 Photostatically reproduced, reports of sightings from around the world. Starting from 1943 to the present. Many never before published photos and other material. This book is only sold direct by the authors-publisher. TEL. 416-922-9850 \$4.95 plus 75¢ postage.

SAMISDAT PUBLISHERS
206 CARLTON STREET
TORONTO, ONTARIO, CANADA M5A 2L1

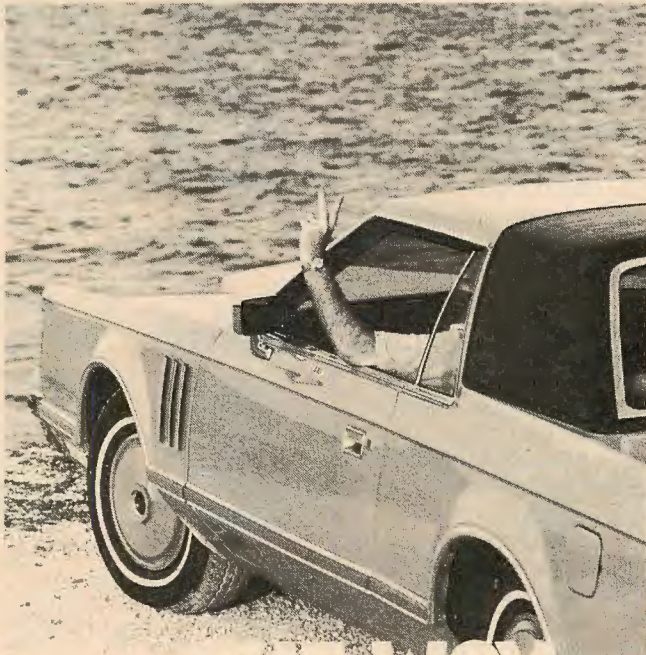

**ALL THE WAY
WITH TEDDY K**

IF KENNEDY TAKES THE PLUNGE . . .

Quietly, the Far Left—dissatisfied with the Prince of Peanuts—is pushing Prince Charming of Chappaquiddick. This 2x3 black-and-yellow poster graphically reminds people of those long-ago events surrounding the senior Senator from Massachusetts, who panicked in his car, but who now would like to have his finger on the buttons in the White House. Destined to be a collector's item, this poster is ideal for display between now and the 1980 elections—especially wherever voters congregate (offices, gas stations, stores, meeting halls, lodges, truck stops, your own den or family room . . . or near the deep end of your swimming pool).

YES, I'd like to help the voters remember. Please rush me _____ poster(s) at the rate of 1 for \$2.75; 5 for \$9.75 (save \$4); 10 for \$16.75 (save \$10.75), PLUS \$2.25 PER ORDER to cover handling, special mailing tube and postage. (Orders for more than 10 posters MUST be in multiples of 10, i.e., 20, 30, 40, etc.; cost of each multiple is \$16.75 PLUS the \$2.25 handling, tube and postage charge.) Delivery 2 weeks. Enclosed is check or money order, payable to Florida Conservative Union, in amount of: \$ _____

PLEASE PRINT:

Name: _____

Address: _____

City, State: _____

ZIP: _____

MAIL COUPON WITH PAYMENT (which is considered a contribution to FCU, a nonpartisan, nonprofit Florida corporation) to FCU, c/o SOF, Box 693, Boulder, CO 80306

105

**THE COMPLETE
CIA & SPECIAL FORCES
• IMPROVED MUNITIONS •**

BLACK BOOKS

These books were originally developed by the FRANKFORD ARSENAL for the CIA and SPECIAL FORCES. They are the most detailed and comprehensive works ever done on the subject of improvised weapons. For years they have been the most sought after and secretive books ever published by the AMERICAN MILITARY. Only after lengthy and extensive research have we been able to acquire these complete original books and are now making them available to you. Anyone who can foresee the troubled times ahead should not be without the knowledge contained in these books.

— Improved Munitions Black Books —

(BB-1) Vol. 1, 147 Pg. \$9.95
(BB-2) Vol. 2, 141 Pg. \$9.95

DESERT PUBLICATIONS
DEPT. SF. CORNVILLE, AZ. 86325

I have enclosed \$_____ Please Rush me:
_____ copy(s) of BB 1
_____ copy(s) of BB-2

NAME _____
ADDRESS _____
CITY _____ STATE _____ ZIP _____

PHONE TAPPED?

EAVESDROPPER STOPPER



SILENTLY INDICATES WHETHER SOMEONE ELSE IS LISTENING!
\$29.95

Indicates presence of tapping devices. . . if line is busy. . . if extension is listening.

ELIMINATE POSSIBILITY OF TAPS OR UNAUTHORIZED LISTENERS-IN ON PHONE

- Makes your phone secure
- Prevents interruptions and arguments
- Works whether call is being made or received
- Use it at any location
- No interference with normal operation
- Works with party lines

Adjustable for ALL telephone installations

MONEY BACK GUARANTEE
FREE telephone accessories and detection devices catalog with purchase
Send check/money order (add \$2.00 for postage and handling, plus local sales tax)

AMERICAN MAILING, INC.
DEPT. SF-F, P.O. BOX 112
NYACK, N.Y. 10960

have little fear of the condition-one carry with their shotguns or even hunting rifles.

If one cannot live with the SA pistol in condition-one carry, then he may opt for the DA pistol. Safety is a state of mind, not a means of carry. For agencies or armies that must deal with a low training and competence level, the DA auto pistol becomes an attractive choice. Ease of operation may be simple for the first shot, since the trigger need only to be pulled without disengaging a safety. After that, operation becomes more complicated.

I do not think there is any real difference in speed between the first round fired from a DA auto or SA auto pistol carried in condition-one. What I do know from considerable experience is that if both shooters have equal skill, the SA pistol user will place his shot with greater accuracy than the DA pistol shooter.

Negative factors concerning the DA auto pistol are: first, the detail of double-action transition is indeed a serious problem. It requires a great deal of training and practice from the shooter. When one draws a DA auto from its holster, he assumes a firing grip that places the index finger in position along the trigger to provide for a stroke of the long DA trigger pull. After the first shot, the trigger remains to the rear in a single-action manner for the second and following shots. With some designs, such as the H&K P-9S, those with normal or small hands may have to grip the piece off center to position the index finger on the trigger.

On the second shot, the trigger is thus positioned too far to the rear for proper finger-tip purchase necessary for a controlled shot. As a result, the second shot is fired as the finger jerks the trigger, similar to the heavy pressure needed for a stiff DA pull. At close range, this second shot frequently makes a peripheral hit or a total miss.

Some shooters are limited to certain DA designs due to the long reach of the trigger on many models. Those with small hands will find the Smith & Wesson M-39, Walther P-38 or Czech 75 fits nicely and gives a comfortable grip. Other pistols, such as the Sig-Sauer 220, P-9S, Beretta M92 and Seecamp Colt conversions, require a large hand and long finger reach to make proper contact for fast-shooting exercises. What one can do with deliberation and ease on the practice range can be a far cry from what is necessary in a fast-shooting survival encounter.

Learning to shoot the DA revolver takes practice. Revolver shooters use wheelguns with actions tuned for smoothness. Their revolvers are half as light as the double-action autoloading pistol. They have an excessive amount of backlash (distance the trigger moves after the sear has been released), serious enough to hamper real precision shooting. Admittedly, in a combat sidearm this may not be critical. In some earlier designs, the hammer drop safety could cause real ex-

citement from incorrect tolerances or broken parts. Since it has happened in my presence a number of times, I am more than uneasy when this feature is utilized.

It is unfair to declare the DA auto pistol cannot be mastered. I know a couple of men who use it with precision. Both men have worked hard to develop their gun-handling skills. If I had to use a DA auto, then I too would be obliged to learn its technique. Anyone wanting to call himself a pistolero must stay proficient with all types of sidearms. He may have to use another type or model pistol than the one he is used to. It now looks like both

NEW! MILITARY & POLICE BOOKS

JUST PRINTED

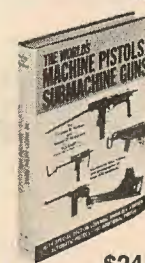

The World's Machine Pistols & Submachine Guns, Vol. 2a

By Thomas B. Nelson & Daniel Musgrave

Over 550 pages—
Detailing 200 guns—
Over 600 photos.

\$24.95

This classic reference covers here-to-fore unknown weapons. Featuring Machine Pistols and new Submachine Gun developments. Also complete photo section of automatic pistols with shoulder-stocks. A must for collectors! (Dealer Inquiries Invited)

JUST REPRINTED

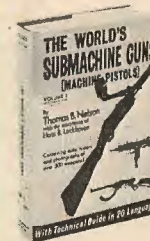

The World's Submachine Guns, Vol. 1

By Thomas B. Nelson

747 pages covering over
300 weapons with
complete data and history.
Over 650 photos and
drawings.

\$24.95

(Dealer Inquiries Invited)

JUST PRINTED

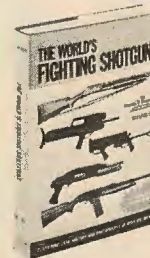

The World's Fighting Shotguns

By noted arms authority
Thomas F. Swearingen

Over 500 pages. Covers
250 weapons. 500
photos—The complete
military and police
reference.

\$24.95

(Dealer Inquiries Invited)

This magnificent book was 8 years in the making. Never before has such a book been offered covering Fighting Shotguns. A must for every police and collector library. Historical data from the shotgun's inception to present day with all up-to-date developments.

ALSO REPRINTED

THE WORLD'S ASSAULT RIFLES by Daniel Musgrave and T. B. Nelson. 546 pages with over 450 photos. Featuring data and history of 200 primary assault rifles—a MUST for the serious arms historian. **Only \$19.95**

Include \$1.00 to cover postage/handling for each book.
T.B.N. ENTERPRISES, Dept. SO119
P.O. Box 55, Alexandria, Virginia 22313

Satisfaction assured, book may be returned for refund if not satisfied. (Dealer Inquiries Invited)

friends and foes around the globe are taking up the DA auto pistol.

For basic work with the DA auto, other than just chance encounters, let me suggest my method of application. At close combat ranges (10 meters or less), use the double-action pull for the quick first shot. Go for first-round hits. At longer ranges or for precision shooting, thumb-cock the hammer with the thumb of the weak hand as the pistol comes up on target to utilize a light single-action pull for an accurate shot.

No top IPSC competitors use DA auto pistols. Although pro-DA auto people may call IPSC a game, they fail to realize that IPSC shooting requires the same skills necessary for a survival situation. Here the DA auto pistol just does not shine. Over the years, I have seen many new shooters enter combat shooting exercises with various DA auto designs. I have heard them argue why the DA is superior, but sooner or later they show up with a single-action Browning design and stick with it.

In theory, the DA auto is great, but in practical application it rarely lives up to its promoters' expectations. Tom Campbell of Smith & Wesson has established his reputation as a world-class IPSC shooter. He uses a custom-made, highly modified S&W M-59 he calls "Supergun." When he built the pistol he converted it to single-action with a cocked-and-locked carry. He wanted a system that worked, not something that sounded good in theory.

RECENTLY, three DA auto pistols have been introduced that provide for a cocked-and-locked override. The pistol can be carried in the normal trigger-forward position, requiring a long DA pull to cock and fire it, or it can be carried with the hammer cocked and with a manual safety engaged, as with the Colt .45 auto. These new designs are the Italian Benelli B76 in 9x19 parabellum, the Czech 75 in 9x19, and the Beretta M84 in .380 ACP. If the Beretta M84, were offered in a serious caliber, it could easily be the best-design fighting pistol in the world. So close and yet so far away.

The double-action auto pistol remains, as Jeff Cooper has accurately stated, "An excellent solution to a nonexistent problem."

WESTERN military intelligence personnel report the use of a new Soviet rifle, a development of the Kalashnikov design. The AKS-74 appears to be chambered for a high-velocity round similar to our 5.56mm. Believed to be a 4.5-diameter bullet in a slightly smaller case than that of the 7.62x39, one wonders about Ivan's logic. Maybe technology exporting has paid off and the Soviets believe Defense Department bull about our dinosaur-killing battle rifle.



"... SECRETS ... LEARNED LONG AGO IN THE ORIENT ..."

Shadow Systems' own brand of custom made Nunchucks, for law enforcement personnel or anyone who needs an extra hand. They're hand finished of indestructible black Micarta and double strung for extra strength and control. To order yours, send \$24.95 plus a dollar for shipping and insurance to:

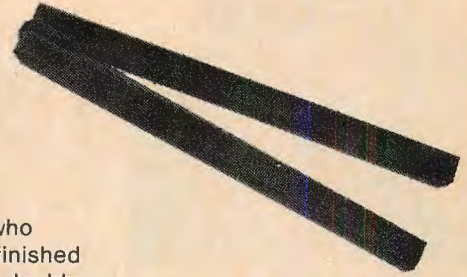

SHADOW SYSTEMS
P.O. BOX 28222 - SOF
ATLANTA, GA. 30328

BOOKS FOR MEN OF ACTION!

Now Available: *THE BEST BOOK CATALOG IN THE WORLD*

* Huge 11 x 15, over 100 illustrated pages!

* Features nearly 500 of the most controversial and unusual books ever printed!

Topics covered include: Self-defense, self-liberation, fake ID, how to hide contraband and valuables, police manuals, guns and shooting, guerrilla warfare, self-reliance, investigative and undercover techniques, black market, tax avoidance, unusual money-making opportunities, intelligence increase, life extension, privacy, and much more!

This huge unique catalog, crammed with VITAL information, is yours FREE when you order any book below. (\$2.00 if ordered separately).

EXOTIC WEAPONS: AN ACCESS BOOK

Need some brass knuckles? A switchblade? A stun gun? Or other hard-to-find weapons? **EXOTIC WEAPONS: AN ACCESS BOOK** is an absolute must for the man of action! More than 90 different weapons are described and illustrated with over 120 photos! More than 300 dealers are listed, and sources of further information provided

in a large 8½x11 well-organized and easy-to-use 94 page book! **\$6.95**

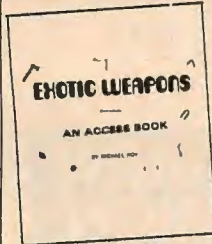

DIRECTORY OF MAIL DROPS IN THE UNITED STATES AND CANADA

Do you have "unusual" mailing needs?

The **DIRECTORY OF MAIL DROPS** is a must for many clandestine and security operations. Complete names and addresses of more than 800 places where you can rent a confidential address for your "special" mail are listed, including dozens in Canada and other foreign countries. Well-organized and easy-to-use. **\$4.00**

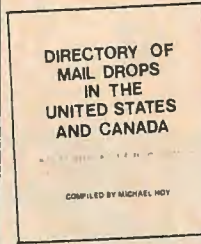

THE CODE BOOK

All About Unbreakable Codes and How To Use Them

Hard-to-find secrets known only to international espionage agents and professional cryptographers now revealed for you to use! **THE CODE BOOK** tells you all there is to know to produce your own unbreakable codes! Do it by hand, use a pocket

calculator, or use a microcomputer! Written in plain, easy-to-understand language, **THE CODE BOOK** is a must for anyone in need of privacy. **\$6.95**

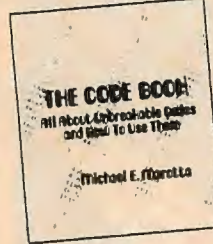

CLOSE SHAVES

The Complete Book of Razor Fighting

For the first time, a book on the little-known and bloody art of fighting with a straight razor! This illustrated manual covers offense, defense, types of wounds, care of your razor, and much more! **CLOSE SHAVES: THE COMPLETE BOOK OF RAZOR FIGHTING** will make you an expert in this esoteric combat art! **\$8.00**

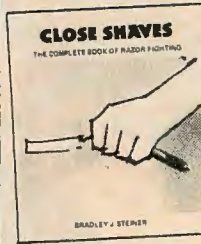

LOOMPANICS UNLIMITED

P. O. Box 264

Mason, Michigan 48854

SOF

REMEMBER!

Our huge 11 x 15 100 page illustrated catalog is **FREE** with any book! (\$2.00 if ordered separately).

Name _____
Address _____
City _____ State _____ Zip _____

Qty.	Title	Price	Total

Please include \$2.00 for shipping and handling.

PERSONAL DEFENSE

Blackie Collins & Chris McLoughlin



Exciting and useful new book on armed defense. Heavy emphasis on firearms and edged weapons with 234 all new photographs. Weapons concealment and escape and evasion techniques are discussed in detail. This is a large format book with 160 pages of interesting information and high quality photographs. A must for these days and times.

\$8.95 Softbound

Send check or money order to:

Defense

P.O. Box 18595

Dept. SOF

Atlanta, GA 30326

All orders shipped post paid.

BOMBER BONEYARD

Continued from page 35

'Caroline.' Lyndon Johnson used it, too, in his campaign against Goldwater."

The speaker, Snow, is something of a historical aerial curiosity himself. Dutch Snow is one of the few men to have fought in modern wars both as an infantryman and a pilot. Snow was a rifleman in the Seventh Marine Regiment in Korea, made the Inchon landing, helped clear North Korean forces out of Seoul and while taking a breather from such interesting pursuits one day, heard about the MarCad program. Under it, a Marine enlisted man could, if he met the qualifications, volunteer for pilot training. Snow did, won his wings and returned to Korea first as a Corsair jockey and later as a helicopter medevac pilot, one of the first of them. And Snow has also done some flying as a "contract military technician," shall we say, in Africa and Latin America.

The 40 planes have now grown to more than a hundred. An historic civilian craft to be seen is the oldest surviving Constellation, the four-engined passenger planes that were hugely popular with travelers until jets and prop-jets rendered them obsolete for long-distance travel. This "Connie" was the third off the line, its serial number shows; the first two have been long since scrapped.

Another civilian aircraft at Pima is a Boeing S-307 Stratoliner, which, with their new feature, a pressurized cabin, were called in the late 1930s the "Castle in the Air."

WARBIRDS

But most planes at Pima are war birds, and as Snow explains, "Unfortunately, wars have precipitated more advances in aircraft technology than any other factor. Therefore, you'll see more military aircraft here than anything else."

And one of the most interesting of them visitors will see there is a beat-up old Gruman F6F "Hellcat," an aircraft which did its share in phasing out the Japanese navy during World War II. Most of the planes at Pima have been restored to a like-new appearance but not this one.

That is because of its history. Piloted by a Navy flier, the Hellcat developed engine trouble during a test flight after a maintenance overhaul. The sailor bailed out 12 miles off the coast of San Diego, the plane plunging into the ocean, and a Coast Guard cutter picked him up. The aircraft itself remained on the bottom — 3,400 feet down — for the next 26 years, when it was discovered by a Lockheed research submarine during Operation "Deep Quest," seeking to probe the secrets of extreme ocean depths. One of those secrets turned out to be the old Hellcat.

A combined Navy-Lockheed effort surfaced the plane so the effects of deep water corrosion could be studied. Surprisingly they were small, considering the length of time the Hellcat had been submerged in salt water, probably because of the extreme depth and cold down there. For example, the inboard port wing Browning .50 caliber was cleaned, inspected, lubricated and fired — without a mechanical malfunction. Museum officials decided to leave the Hellcat just as it was found as a testimony to its durability.

SOVIET FIGHTER

Some visitors who have fought communists in a war or two are surprised to see a fighter plane with Soviet Union insignia. It is a P-63 Kingcobra, fully restored with a brand-new paint job and it symbolizes the 2,400 planes of its type sent to Russia to fight Nazi tanks from the air during World War II.

For those who spent more time crunching gravel, slogging through mud and sleeping out in the invigorating open than they did winging through the wild blue yonder and whose only association with airplanes was being taken to unpleasant places in them, there are a number of nostalgia arousers, including a fully restored C-47 "Gooney Bird," the transport that took a lot of goods and folks to a lot of places in WWII, Korea and even Vietnam.

AN INVESTMENT IN PRECISION.

AL MAR KNIVES
5861 S.W. Bentfield Court
Lake Oswego, Oregon 97034
U.S.A. (503) 639-8554

Most work at Pima Air Museum is done by 100 or so wageless volunteers who do everything from painting a WWII barracks at the Museum to selling souvenirs. Two of the paid employees are Acting Museum Director Ray M. Morgan, retired former general manager of Trans-World Airlines in Las Vegas, Nev., and Bob Johnson, assistant director, who retired in 1976 after 27 years in the old Army Air Corps and the U.S. Air Force. He is never happier than when grease-smearing and crawling around inside the guts of a vintage aircraft.

Admission to the Museum is \$2.00 for adults and 75 cents for juniors aged 12-17.

The opening scene in the movie, *12 O'Clock High*, consists of a former flight surgeon visiting, while on vacation in England, the airfield at which he had served many years before in WWII. As he stands on the cracked, grass-grown runway, he begins remembering the camaraderie, the fun, pain, danger and sorrow of that brief period of his life, the war. His one grand adventure in an otherwise humdrum existence. He recalls the cowards and the heroes and the dead and the survivors.

That is the kind of feeling of nostalgia inspired by and at the Pima Air Museum.



Dealer Inquiries Are Invited

Wear Your Knife In A

SHOULDER RIG...

Now any knife with the classic boot/belt clip (Gerber Mk I, Jakal, Quicksilver, Vindicator, etc.) can be worn on our special shoulder harness rig. The kit includes instructions, black nylon harness and easily installed adapters.

To order send \$8.50 + 50¢ postage to:



ARMAMENT SYSTEMS PRODUCTS, UNLTD.
P.O. Box 18595 - SOF
Atlanta, Ga. 30326

12 OFF - USA made 100% legal AMAZON **USE 30 DAYS UNAVAILABLE ELSEWHERE** (Returns weapon New Improved - 30% More Powerful!)

100 STEEL .38 caliber FREE DARTS BUY 2 GET 600 BONUS DARTS

SURVIVAL HUNTING BLOW-GUN **GUARANTEED 15 YEARS** **Now Only \$7.98** (List \$15.95)

SILENT, POWERFUL, ACCURATE, HITS BATTLE BULLET! Improved version of famous Amazon hunting blow-gun. Thrilling sport! Kills varmints, pests, Defense, ideal gift. Compressed breath gives amazing power. 220 ft range. Astound friends! Rugged .38 cal, precision aluminum, 2-WAY rubber m. diecu. Pierces 1/2" plywood. Speed 300 ft/sec. Not a toy! Has 100-3" .5" steel darts (kit) carry case, instructions. Compact 4 1/2 ft. model \$7.98! Popular 5 1/2 ft. \$8.98! Magnum 6 1/2" \$9.98! Extra darts \$2.50 per 100! \$4.50/200! \$11.50/500! Super BONUS BUY 2 GUNS GET 1000 darts, sling, quiver, patches, camouflage, targets, carry box (\$22 Free)! BUY 3 GET SAME + cleaning rod, muzzle guard + 1100 (\$40 Free)! BUY 4 SAME + Guerrilla Gun + 1600 (\$60 Free)! BUY 5 SAME + FREE 7th GUN! - 1600 Free! Add \$1.95 postage EA Gun. Send cash, check, m.o. IF BROKEN WITHIN 15 YEARS WE WILL REPLACE! Use 30 days. Money back if not delighted. HOUSE OF WEAPONS, INC. Box 7948 Provo, Utah 84601. Ask for operator #7201. VISA/Master Charge CARD orders ONLY! CALL TOLL FREE NOW 24 hrs: 800-824-7888. Calif 800-852-7777. AK/Hawaii 800-824-7919.

"COBRA"
P.O. BOX 30035
MIDWEST CITY, OK 73110

S.W.A.T. SLING FOR RIFLES OR SHOTGUNS
SPECIFY: Black or C.O.D. & Caliber or Gauge.
For Q.D. Swivels \$24.95 STD. 1 1/2" \$21.95
Include \$1.50 Postage or order C.O.D.
Send \$2.00. for "COBRA" products catalog.

JUNGLE TENT HAMMOCK
For Outdoor Comfort-Rainproof Top-Mosquito Proof Netting-Zipper Side Opening - 28" x 74"

Camp Gear
River Rafts.
Catalog \$2 00

\$39.95
\$3 00 Post./Handl

Tyco Co. INC Dept. S O F 8344 Leesburg Pike Vienna VA 22180

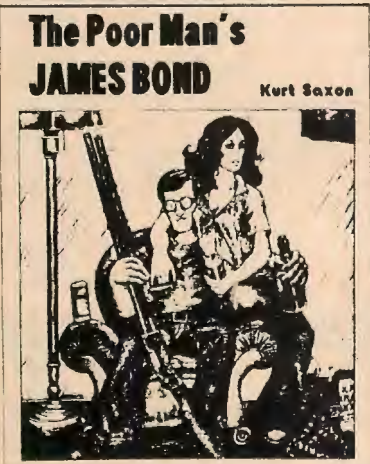

THE POOR MAN'S JAMES BOND
\$11.00

THE POOR MAN'S JAMES BOND is the undisputed leader in the field of books on improvised weaponry and do-it-yourself mayhem. It gives full and simple instructions for making tear gas, explosives, firearms, silencers, poisons, zigguns, grenades, knock-out drops, flame throwers and a wide variety of weapons. It also tells you how to buy most of the needed chemicals from your grocery and garden store. Includes FIREWORKS AND EXPLOSIVES LIKE GRANDDAD USED TO MAKE. This book has hundreds of formulas and processes for making fireworks, blasting compounds, gunpowder, nitro, guncolton, etc. The material was gleaned from formularies written from 1872 to 1907. Plus: George W. Weingart's classic on fireworks, PYROTECHNY. This is the simplest and most comprehensive book on actually making fireworks. It is heavily illustrated in how to make Roman Candles, Shell Cases, Fuses, Colored Fires, Explosive Powders, Rockets, Mortars, Firecrackers, Torpedoes, etc. Plus the complete text of EXPLOSIVES, MATCHES AND FIREWORKS by Joseph Reilly, 1938. This is a rather technical work on the analysis and testing of explosives. All these combined make THE POOR MAN'S JAMES BOND invaluable for survival.

Lock Picks

LOCKSMITHS & STUDENTS

These tools are sold for instructional purposes only. The seller does not accept any responsibility for their misuse.

All picks made of .022 hardened blue spring steel with non-breakable, polyethylene, slip proof, color coded handles.

<p>PIX-QUIK MODEL A</p> <p>Six picks, two torsion wrenches, and case.</p> <p>12.00</p>	<p>PIX-QUIK MODEL B</p> <p>Ten picks, three torsion wrenches and case.</p> <p>20.00</p>	<p>PIX-EZ</p> <p>Folding, self contained pocket style. Only 4" long, 2" square. Six picks and one torsion wrench which also acts as pocket clip.</p> <p>26.00</p>
---	--	--

LAW ENFORCEMENT MILITARY SECURITY

SOF IN STORE OR BY MAIL CATALOG \$1.00
ALL ORDERS: MONEY ORDER, CERTIFIED CHECK, VISA OR B. OF A. PERSONAL CHECKS HELD 2 WEEKS

THE LARDER-SURVIVAL BOOKS
11106 MAGNOLIA BLVD., DEPT SF
NORTH HOLLYWOOD, CA 91601
(213) 763-0804

THE LOCKAID TOOL
The Lockaid Tool was specifically designed to pick pin tumbler locks over thirty years ago as an aid to law enforcement agencies and locksmiths. Since then, it has been continuously evaluated and improved.

75.00

IMPORTANT

Certain local authorities impose licensing requirements, and other restrictions, upon the locksmithing trade. (For public protection.) In such areas, the laws generally stipulate that the actual practice of this craft is limited to licensed locksmiths and apprentices. In addition, (wherever these laws apply), possession of any form of lock picking tool may be prohibited to all those other than licensed locksmiths, apprentices, students of the trade, or those who are "otherwise" authorized. (If you are in doubt as to your local regulations, check with your police chief.)

For the foregoing reasons, the following (signed) statement must accompany all orders for "picking" tools.

I am licensed by local authority to practice the trade of Locksmithing -- or I am a licensed Apprentice Locksmith OR

I am over twenty one years of age I have never been convicted of a felony, a larceny related misdemeanor or any crime which might preclude my participation in this trade

I am interested in learning the locksmith trade for the purpose of legitimate enterprise. I am presently enrolled in an accredited locksmithing school, OR I have elected to learn this trade through the process of "self teaching". I am fully aware of the laws which govern the practice of this trade, and I understand and recognize the responsibilities related to the conduct of this trade.

DATE: _____ SIGNATURE: _____

HECKLER & KOCH
H&K

FACTORY MANUALS

HK 91 \$6.50	HK 93 \$6.50
-----------------	-----------------

HK 91 and HK 93, HECKLER and KOCH Factory Manuals. Illustrated, 50 detailed pages covering maintenance, operation, cleaning, accessories, Semi-Auto, Full Auto, and Burst Fire functions. Catalog \$1. Money Order only; Survival Books.

GUARD AND ATTACK TRAINING



Train your K-9 to respond aggressively, to guard and attack on your command. This 8-track tape and picture manual give you the professional training techniques to make your dog a Man Stopper. Don't waste your dog by leaving him untrained.

Just send check or money order for \$16.95 to:

B & M Enterprises, P.O. Box 3303A
Parkersburg, West Virginia 26101

BEWARE OF THE DWARF



The bastard of the mating of wormeaten wood with twisted steel, the Dwarf is an evil companion that you wouldn't want to take home to mother ... but it is a sturdy mother. The Dwarf has no saving graces, but at under 7" overall — and with its special black sheath — it can be hidden almost anywhere. You'll have to see it to believe it ... but Beware.

To Order Send \$22.50 to:

ARMAMENT SYSTEMS PRODUCTS, UNLTD.

P.O. Box 18595 — SOF
Atlanta, Ga. 30326



ADVENTURERS TELEPHONE AND TEST SET

MODEL 1011



CONNECTS ANYWHERE ON LINE
MONITORS AND TESTS, OR MAKES CALLS
MADE OF RUGGED, NON-REFLECTIVE BLACK RUBBER

\$75 With Shipping & Ins. Paid
CASH, CHECK, MONEY ORDER
VISA* & MASTER CHARGE*

ALSO AVAILABLE: *Send card number and expiration date

Green Plastic Dial-in-Handset style Test Set
Push-Tone and Dial combined Test Set
Battery powered Field Phones
Sound powered Field Phones
Telephones and Books on Telephones
CATALOG: \$1.00

Việt-American™

109 Fire Lane, N. Cape May, NJ 08204

WILL THEY FIGHT?

Continued from page 78

shots at a known distance in a target, than he does from spraying a magazine of rounds at a silhouette target." And Van Meter would like to have the Army return to teaching soldiers how to navigate in the boondocks without a compass — land navigation by using reference points, the sun or stars and landmarks. Again, more reactionary than revolutionary (but perhaps it is revolutionary in an Army that seems determined to de-emphasize fighting and survival.)

In these studies, a dozen factors have been massaged with a dozen objections, no doubt using computers and tons of data. It is another manifestation of what has become the Army management system, a systems analysis for finding complex solutions to simple problems. It is all quite enough to do the Harvard School of Business proud. If the generals and colonels were shipped over to IBM and General Motors and Exxon, they would do mighty well for their new bosses, and their companies would grow fatter still with profits.

They ain't gonna fight.

But an infantry platoon is not a filling station. Nor is it a car dealership, nor a regional sales force. It is a group of men with hand-held weapons and whatever they can carry on their backs. What this country must ask of an infantry platoon in combat is not deliverable for the price of management or persuasion.

It can only come through discipline, by leadership. Those in the topmost echelon of the Army have committed their reputations to the concept of a volunteer Army. They have assured and reassured Congress and the public that their goals can be met, and now they have learned, or are learning, that they have been wrong, and they cannot admit it.

The officers beneath them know that overt or public disagreement with their bosses can damage or shorten a career, and they hew to the party line. The word has gone down through the ranks, from the Pentagon to the platoon, and the word is: make it a place where there are enough warm bodies getting through various training programs to fill the ranks so that we can say that the volunteer concept is working. The result, as Hal Van Meter puts it, is a trainee that is motivated (but has not really been challenged), physically fit, technically and tactically proficient in 40 basic infantry skills, and relatively disciplined. And the result, as the noncoms who will have to lead these relatively disciplined infantrymen is: "These guys ain't gonna fight."



Kalishnikov

A SOVIET SOCIAL DISEASE

CUSTOM DESIGNED T-SHIRTS
Highest Quality, Colorfast Original Designs. Sizes: S,M,L,XL

**STAY ALIVE
CARRY A .45
FIGHT CRIME
KILL A BURGLER**

Please state size, design selection and send \$7.50 + \$1.50 shipping & handling, cash or money order to:

BRAVO YANKEE

P.O. Box 5346, Riverside, Ca 92517

California residents add 6% sales tax.

MAGNIFICENT BRASS PAPERWEIGHT

Full size replica of the Knuckle Duster

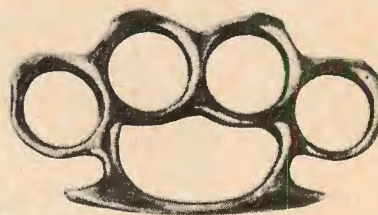

ORDER TODAY!
\$7.95 postpaid

Aluminum paperweight I
\$3.95 postpaid

For novelty paperweight use only.
Not intended for any other use.

Send check or M.O. to:

BEST SPORTS SUPPLIER

P.O. Box 4, Dept. 14
Hazelwood, Mo. 63042

ADVENTURERS TELEPHONE TEST SET

Clips on anywhere.
Monitors phone conversation.
Undetected while testing.
Flip switch and place calls.

Green Plastic — as pictured
Black Rubber — (Not shown)

Don't Leave Home Without It!

\$85.00 Ins. & P.P.D.
Money Orders, Visa & Master Charge. Send \$1.00 for Catalog



TEL-TEST

P.O. Box 278, Butler, Ohio 44822

MILITARY TOMAHAWK—\$7.95
 This Authentic Special Issue Throwing Ax was once used for Wilderness, Outdoor-Survival, Hand-to-Hand Combat, and even Hunting! Now available to you with a Heavily Chrome-Plated Head and "Military Surplus Prices" with Handle of Genuine Hickory.

Special Collector's Catalog - \$2.25 contains selections of Historical and Military Equipment, Frontier and Wilderness Survival Tools, Combat Knives, Tomahawks, Throwing Axes, Crossbows, and Hunting Items.

SPECIAL FORCES BOOT KNIFE—\$3.98
 The only Knife with the Regular Edges of a Combat Weapon that can be used for Long Range Throwing. A Leather Sheath comes with this Rugged One-Piece Ranger Knife. Designed with Rigid Government Standards for Units Operating Deep in Guerrilla-Infested Jungles. Now available to you at a third of the cost.

MARK-II "CRUSADER" \$4.95 CUSTOM ISSUE
 Carried by Marines, Paratroopers and Elite Special Strike Units Whether Used to Cut Cords on a Parachute Harness or as a Weapon for Defense in Critical Situations, "Crusader is King!" No-Slip Finger-Grip Handle with Rugged Back-Lock makes it a Dependable Friend in a Crisis! Available as Genuine Issue in Short Supply Only!

WESTERN AND ROCKY MOUNTAIN ARMS CO.
 Dept. W48 P.O. Box 311, Aurora, CO 80040

Urban guerrilla war and nuclear terror in America in the 1980's . . .

THE TURNER DIARIES
 Earl Turner and his fellow patriots in the Organization are forced underground when the U.S. government bans the private possession of firearms and stages the mass Gun Raids to round up suspected gun owners. The hated Equality Police begin hunting them down, but the Organization fights back with a campaign of sabotage and assassination. The ingenuity and boldness of Turner and his comrades in devising and executing new methods of guerrilla war lead to a climax of cataclysmic intensity and worldwide scope. **The Turner Diaries** is a book unlike any you've ever read! Illustrated, 315 pages.

Author Andrew Macdonald is a nuclear physicist and an expert in improvised munitions, terrorist gadgets, and military/industrial sabotage. His descriptions of devices and techniques are graphic and detailed. His scenario is terrifyingly realistic.

THE TURNER DIARIES . . . \$4.95
 (Add 50 cents for postage to your remittance.)
National Alliance Books, Dept S, Box 3535, Washington, DC 20007

**Are you bored?
 The excitement of
 the world of intrigue
 and adventure
 awaits you in,
 COVERT INTEL
 LETTER**

**SAMPLE/\$1.00 or \$11.00/12 ISSUES
 Overseas Air \$15.00/12 issues**

HORIZONE

Box 67, St. Charles. MO 63301, U.S.A.

FLAK

Continued from page 17

nam. Sir, I say that is bullshit! We lost nothing.

1. In order to lose something you must set out to win it. The United States government had no intentions of winning the damn thing to begin with or they would have declared war on the North Vietnamese and done to them what was done to the Nazis and Japanese fascists. Our government's expressed aim in Vietnam was to take and build the South Vietnamese military into a fighting machine capable of defending their own country (a feat Napoleon would have had trouble with). We did what we could in 10 years, then split.

2. The United States military was never beaten on the field of battle by the VC or the NVA. Every time the enemy fielded a unit against an American force of equal (or smaller) size, we literally shot them to pieces. I would like to believe that we demonstrated to the communists and the rest of the world that we had an excellent, well-equipped, well-trained, well-led army capable of fighting on equal terms with an enemy operating out of his own territory, on his terms, with his rules.

3. If you want to find the people that lost that war, look to Nixon and his minion, Kissinger, who sold us out to the communists so they could continue to live at taxpayers' expense.

Goddamnit, stop blaming the military and the men who fought the war. We didn't lose the damn thing, the country did! I was there.

With fraternal greetings,
 Matthew St. Clair, Jr.
 Captain, Infantry (Reserve)
 Key West, Florida

SOF has never suggested that the U.S. military lost the war in 'Nam. We were there too. Otherwise, all that needs to be added to your letter is "Amen."—The Eds.

**LADY'S
 MANSTOPPER . . .**
 Sirs:
 Regarding "10-Gauge Manstopper" (October '79), Mr. Nickerson might be comforted to know that others are pursuing a manstopper not dissimilar from that which he has focused upon and which, incidentally, would appear to answer many of the objections set forth by Mr. MacDougald.

A female employee, working in my office, was recently subjected to terrorism by three young hoodlums who were fleeing from police after being apprehended breaking into a neighboring bar. They

Continued on page 90

BLACK MEDICINE The Dark Art of Death

by N. Mashiro

This book represents the most thorough and intriguing discussion of the human body's vital points ever to appear in a single volume. Through strikingly realistic photographs and detailed line drawings, Mashiro illustrates over 150 parts of the human body where a minimum amount of force will produce a maximum impact on a person's ability to fight. The study of these final points is integral to all branches of the martial arts, to the military combat specialist, and to everyone concerned with self-defense.

BM . . . \$9.00

THE POOR MAN'S JAMES BOND

by Kurt Saxon

The Poor Man's JAMES BOND
 Kurt Saxon

THE POOR MAN'S JAMES BOND is the undisputed leader in the field of books on improvised weaponry and do-it-yourself mayhem. It gives full and simple instructions for making tear gas, explosives, firearms, silencers, poisons, zipguns, grenades, knock-out drops, flame throwers and a wide variety of weapons. It also tells you how to buy most of the needed chemicals from your grocery and garden store.

.....\$11.00

HECKLER & KOCH • H & K FACTORY MANUALS

Illustrated, 50 detailed pages covering maintenance, operation, cleaning, accessories, Semi-Auto, Full Auto, and Burst Fire functions.

HK 91 . . . \$6.50 HK 93 . . . \$6.50

Catalog \$1.00 • Money Orders Only • In Store or by Mail

SURVIVAL BOOKS
 11108 Magnolia Boulevard
 North Hollywood, California 91601
 (213) 783-0804

Make Money at Home in Spare Time

No Previous Experience Needed

LEARN GUN REPAIR!

BE A "GUN PRO"—the man other men respect when it comes to guns.

Your love of guns and shooting can be the first step toward an exciting career. Be a sales counselor for a gun shop, sporting goods store, discount house. Manage shooting club or range. Or start your own business—sell or repair guns.

BE YOUR OWN GUN EXPERT We show you how to buy and sell guns...customize, repair and accurize them...fit and finish stocks. Learn all about ballistics...black powder...how to import guns.

Graduation from this course does not insure that you will get a job. To find out how our graduates have done, send for our job placement record.

We Show You How To Apply for a Federal Firearms License Buy and sell guns, ammunition and accessories while you are still a student at North American. Start making extra cash almost immediately—order guns for others on cost-plus basis with no investment.

First lesson reveals secret that increases hunting accuracy.

Your friends won't believe their eyes when they see how your shooting improves. A simple, easy-to-understand chart included in your first lesson gives you new accuracy.

CALL TOLL-FREE
1-800-228-2028 / EXT. 146
 Dept. RS030
 (Except in Nebraska call (402) 571-4900/Ext.146)

CALL ANYTIME—Operators to take your call 24 hours a day, 7 days a week. No cost. No obligation. No salesman will call.

OR MAIL COUPON TODAY!
 North American School of Firearms, Dept. RS030
 4500 Campus Drive, University Plaza, Newport Beach, CA 92660
 Rush me information telling how I may become a GUN PRO.

NAME _____ AGE _____
 ADDRESS _____
 CITY _____ STATE _____ ZIP _____

HOW TO MAKE MONEY WITH GUNS

631

OR MAIL COUPON TODAY!
 North American School of Firearms, Dept. RS030
 4500 Campus Drive, University Plaza, Newport Beach, CA 92660
 Rush me information telling how I may become a GUN PRO.

NAME _____ AGE _____
 ADDRESS _____
 CITY _____ STATE _____ ZIP _____



KILL OR GET KILLED
BY
COL. REX APPLEGATE
"The classic police training text on close combat shooting and riot control."
CLOTHBOUND... \$15.95

Mercenary's Man. 17.95, II 7.95... How To Kill I, II 5.00 ea... Anarchist Cookbook 9.95... Sniping, U.S.M.C. Man. 6.95... Firearms Silencers 6.00... CIA Explosives for Sabotage 5.95 add 10% for postage Calif. 6% tax Book List 1.00 LOS ANGELES area, see before you buy. We stock S.O.F., ATLAN, PALADIN, DESERT, HALE, and many others.

the LARDER, Dept. SF
11106 MAGNOLIA BLVD., NORTH HOLLYWOOD
CALIFORNIA 91601 (213) 763-0804
B of A VISA MASTERCHARGE

YOU'RE UNDER SURVEILLANCE!!

A HOST OF PEOPLE, AGENCIES, AND COMPUTERS ARE BUSY SPYING ON YOU AND YOUR BUSINESS EVERY DAY, OFTEN ILLEGALLY

HOT TO STOP IT OR DO IT BACK!

**THE
BIG
BROTHER
GAME**



A Large Format (8 1/2" x 11") Quality Paperback, 240 Pages

**BUGGING
WIRETAPPING
TAILING
OPTICAL AND
ELECTRONIC SURVEILLANCE
SURREPTITIOUS ENTRY
DETECTIVE TECHNIQUES
WEAPONS
COUNTERMEASURES**

\$11.95 POSTPAID

FREE! With this order. Shoplifting booklet for detectives plus other investigative brochures of books & material.

Quimtronix

P.O. Box 548 • Dept. 38
Seattle, WA 98111

**SOUTH AFRICAN
REPORT & COMMENTS**

BE INFORMED OF
EVENTS & HAPPENINGS
IN SOUTHERN AFRICA

**\$12.00 PER YEAR - U.S.A.
\$15.00 PER YEAR - ABROAD**

FOR SUBSCRIPTION SEND CHECK
OR MONEY ORDER TO:

S.A.R.
P.O. BOX 34-1728
CORAL GABLES, FLA. 33134

BULLETIN BOARD

Continued from page 29

**COUNTER REVOLUTION
BREWING IN NICARAGUA? ...**

Rumors from reliable sources indicate many people have and are giving money for such an attempt. A few million dollars have been amassed already and an unknown country is supposed to supply weapons when the time comes.

The apparent leader of the force is Gen. Sam Genei, Anastasio Somoza's former chief of security.

Some ex-National Guardsmen have been asked to participate. Reports indicate as many as 7,000 ex-National Guardsmen are present in Honduras. One of the largest NG units that retreated across the border when the Sandinistas took over was controlled by Commandante Bravo, who held out to the end in Rivas to the chagrin of the Sandinistas, who announced Rivas as their capital before they had control of it.

Bravo was reported assassinated in Honduras' capital Tegucigalpa some weeks ago but some reports indicate he may still be alive. A badly decomposed body was identified as his by his wife but rumors are that the fingerprints of the corpse and Bravo's — on file in Mexico — do not match. Control of Bravo's unit appears to be in the hands of a Chinese-Nicaraguan first lieutenant named Wong and a Nicaraguan first lieutenant named Lopez.

The border area between Nicaragua and Honduras has been the scene of unconfirmed reports of sporadic combat between former National Guardsmen, who have made some raids back into Nicaragua, the Sandinistas — in hot pursuit — and the Honduran army, which objects to the hot pursuit.

A fourth force involved in the border battle, the Frente Morazanico Liberacion Nacional (FMLN), is a Sandinista-style Honduran revolutionary movement. A la the FSLN (Frente Sandinista Liberacion Nacional) the FMLN is named for a national hero — Honduran Gen. Francisco Morazan, president of the Central American Union in the 19th century — and it uses a red and black flag.

Some infighting continues in Nicaragua between the Sandinistas. The FSLN was made up of forces covering the political spectrum and in the post-victory shaking-out some long-time Sandinistas have been assassinated.

The FSLN also has some equipment problems. The Sandinistas destroyed the guard's radio equipment and they are now facing a com-

munications problem. The FSLN is also reported to be low on ammo for its few heavy weapons.

The recent Sandinista announcement that trials would be held for some 7,000 persons in custody (only about one-half are former NG) is causing some internal strife. Among the 7,000 slated for trial are 33 boys, whose ages range from 11 to 15, and 30 women.



**SUPPORT
SOF**



ADVERTISERS

Be Prepared!

**"LEARN TO SURVIVE"
Ken Hale's "1980"**

CATALOG OF BOOKS ON SURVIVAL
AND RELATED SKILLS

My New Book Catalog is Ready

"BE A SURVIVOR."

Only the wise and strong shall survive the coming turmoil in America Depression, Economic Collapse, or even NUCLEAR WAR I? We cover SELF-DEFENSE, WEAPONS, LIVING IN THE WILDS, GUERRILLA WARFARE, DEMOLITIONS, plus much more.

If you don't have my catalog yet . . . DON'T DELAY!

**It's the BIGGEST & BEST
in its Field. Rush \$1.00 CASH
to: KEN HALE (309)**

**McDONALD, OHIO 44437
"LEARN TO SURVIVE"**

**I'll send it free, if you don't have
a buck, But GET IT NOW . . .**

Send to -
Name _____
Address _____
City _____ State _____ Zip _____

CASHING IN ON AMERICAN UNITY

by Brigham Schreiber

THE capture of the U.S. Embassy by fanatic followers of the Ayatollah Ruhollah Khomeini has united the American people in a grassroots ground swell, despite the Islamic leader's attempt to split the nation along racial lines. Most people feel that the U.S. has not been this united since WWII.

Now a few opportunistic American business men have built up false hopes among the Wild Geese. The most blatant exploitation of mercenaries and men with combat service appeared in an advertisement in the Casper (Wyo.) *Journal* and was picked up by noted Washington columnist Jack Anderson on his daily radio show.

The above ad was merely a hoax to which over 100 Wyoming combat-hardened veterans responded quickly, wishing to free their American brothers, still held at this writing in the embassy in Tehran.

Wyoming, a sparsely populated state, has devastatingly hard winters and hot dry summers. The words of Cole Younger, "We are rough men, used to rough times," sums up the life style and attitudes of many Wyoming citizens.

According to Stanley Rudin, PhD, who appears to be a traveling psychologist: "The ad was placed in the *Journal* to draw attention to our new employment agency." Rudin, born in West Virginia, has worked in South Dakota and in Rock Springs, Wyo. He recently moved to Casper.

His business partner in the employment agency, Mike Spring, says he worked for Naval Intelligence in the Philippines prior to operating as a covert BATF agent. He says he was disabled when he was shot in the left knee in 1977 and was retired on disability. Spring's wife, Sharon, serves as a receptionist at the firm's new office.

When SOF asked Dr. Rudin if he had ever worked for "The Company," he smiled and said that he had not worked for the Agency in any official capacity per se, but had done "a little consulting" for the Langley, Va.-based government agency.

Other bits and pieces of information do not fall into place quickly or easily. Neither Spring nor Rubin have home telephone numbers listed in their names. When asked about this omission, Rudin explained he and Spring had the telephones listed in their wives' maiden names.

Rudin and Spring's agency will act as a legitimate employment agency and has received orders from established businesses in Casper, an energy boom town. The partners claim they have no desire to put together an international strike force to free Iran's hostages.

Was it all a gimmick? Their backgrounds are compatible with contacts for men of the Mike Hoare mold.

MARCH/80

For the present, however, they seem to be content finding jobs for stock clerks, salesmen and a "few for executive placement."

WANTED!!!!!!
FORMER ISRAELI PARATROOPERS WITH 6-DAY WAR AND ENTEBBE EXPERIENCE FOR 6-HOUR MISSION IN IRAN. MUST BE ABLE TO FURNISH OWN GEAR. RESIDENTS OF WYOMING ONLY.
 Casper Journal Thursday November 22, 1979—



CRM5-1

CATALOG AND REFERENCE MANUAL

HEADQUARTERS AND SERVICE COMPANY

S

Our latest catalog and reference manual is here. Sixty 8 1/2" x 11" photo-illustrated pages of U.S. Military clothing, equipment, and camping/survival goods. The finest publication of its type in the industry. Same-day no-hassle service, world-wide shipping, and *NO JUNK*. Nothing more needs to be said. \$1.00 postpaid.

Southeastern Surplus, Inc.
 7228-A Highway 85 Riverdale, GA 30274

QUICKSILVER™

Designed by Danny Thornton, this ultra-lightweight (6 1/2 oz.) survival knife features a watertight aluminum handle that will store emergency items.

QUICKSILVER's blade is 4" of stainless steel, hollow ground with a spear point and false edge. The unique spring clip in the black leather sheath holds the knife securely in any position; the classic boot/belt clip is standard and a shoulder harness is also available. The QUICKSILVER system is fast, safe, simple and complete. Dealer Inquiries Are Invited



The Quicksilver knife is \$49.00; the optional shoulder harness is \$8.50
 To order send to:

ARMAMENT SYSTEMS PRODUCTS, UNLTD.
 P.O. Box 18595 — SOF
 Atlanta, Ga. 30326



ANNOUNCING THE ALL NEW 22 AUTO NINE .22LR High Velocity



.22 AUTO NINE

- Light Recoil
- Fully Machined
- 6 Groove Rifling
- Cocking Indicator
- Pushbutton Safety
- Superb Balance & Pointing
- 9 Oz. Loaded (8 1/4 oz. empty)
- Smaller Than Colt Jr. .25 Auto
- Hard Chromed Slide & Magazine
- 9 Shots (8 in magazine, 1 in chamber)
- Support Sleeve Bushing for Accuracy

FTL MARKETING CORP.

LOWER RECEIVER BLANKS

WITH MAGAZINE WELL IN, MANUFACTURED FROM AIRCRAFT ALUMINUM ALLOY.

LIMITED QUANTITY OFFERED
No License Needed
- May Be Sold To
ANYONE.

\$49.95 + 2.00 Postage and Insurance
Catalog \$2.00 + SASE (Refundable w/order).
A full line of standard and specialized M-16:
"Plus MAC-10 and MAC-11," parts also
available. Scionics Sup-
pressors available.



Send orders to:

J.H. Trager

P.O. BOX 23174
DETROIT, MI. 48223
(313) 537-8021

The NEW Incomparable SKIN-DOC



Self protection! A unique leg-sheathed knife with a Velcro closure system for utmost concealability. Instantly removed for use! Hollow ground knife of 440-C polished steel. Comes with extra suede sheath with Velcro closure adaptable to boots, pocketbook, or anywhere! Knife & leg wrap weighs less than 3 1/2 ounces! Knife measures 5" complete with 2 sheaths.

\$3350

plus \$1.00
for postage
M.C. B.A.C.
M.O. or CHECK

Order yours today!
Phone 404-943-9336 (24 Hr. serv.)
BRIGADE QUARTERMASTERS, LTD.
Box 108-L Powder Springs, Ga. 30073

Security Operations Group

Chalecos Blindados

**Equipos Personales
de Protección**

ASESORES TECNICOS

P.O. BOX 34-1679
CORAL GABLES, FLA. 33134
305-445-3821 - 448-0297

**SUPPORT
SOF**



ADVERTISERS

NEED NEW ID?...CREDIT?

Start life over! Here's how:

Change your name/age/Cover past
Disappear perfectly/Beat the bill collector
Get degrees, better jobs*AAA credit, credit cards, too!

YES! IT CAN BE DONE!

Write: **EDEN PRESS, INC.**
15751 Brookhurst #112-D
Westminster, CA 92683



NAZI-Collectors M-43 Style
Black S-S Caps. Only \$14.00
Postpaid. Order your size NOW.
Our 224 page fully illustrated
catalog only \$2.00 (free with
order).

Over 40,000 Items in Stock
W.W. #2 Ltd. (F) Box #2063
St. Louis, MO. 63158

Telephone Listening Device

Record telephone conversations in your office or home. Connects between any cassette or tape recorder and your telephone or telephone LINE. Starts automatically when phone is answered. Records both sides of phone conversation. Stops recorder when phone is hung up. This device is not an answering service.

Super Powerful Wireless Mic

10 times more powerful than other mics. Transmits up to 1/4 mile to any FM radio. Easy to assemble kit. 15V battery (not incl.)
Call (305) 725-1000 or send \$18.95 + \$1.00 shipping per item to USI Corp., P.O. Box T-2052, Melbourne, FL 32901. COD's accept. For catalog of transmitters, voice scramblers and other specialty items, enclose \$2.00 to USI Corp.



size 1cu

**Each
\$18.95**

Qty. Disc Avail.



size 2"x3"x1/4"

SHOOTERS VS. HUNTERS

by Jeff Cooper

Recently R.D. West of El Paso, Texas, wrote the following letter to Jeff Cooper. Jeff sent it and his reply on to us. We're printing both letters, since we think you'll enjoy reading them as much as we did.

MR. Cooper:

I both respect and admire you. I wish I had half as much knowledge as you do about firearms.

However, upon reading your recent book, *Handguns*, I take issue with you over what you wrote in the epilogue concerning the "Right to Keep and Bear Arms" issue.

You are right — people should know both how to handle and shoot firearms. If I had the opportunity I would probably enroll in your course at API; however, I do shoot on my own. And I would shoot an intruder if I had to.

However, the justification of private ownership of guns is weak. Guns serve four purposes, collecting notwithstanding: one, for target shooting, two, for "plinking," three, for self-defense, and four, for hunting.

The first two are valid; however, the last two are not. To have every person own a firearm for personal defense is to undermine the police. There can't be any confidence in them if we have to arm ourselves. Support of them would be better.

And hunting, although you don't mention the issue, only leads to the development of an attitude of malice toward anything living. As it is no longer required to "support" oneself, killing animals is only detrimental, again psychologically. A peaceful and orderly society cannot exist in such a state.

I know I said I own a firearm and would shoot an intruder; this is true, since *at present*, in self-defense, it would be legal, just as gun ownership is.

I think it would be better and we would be better off if private ownership were illegal; however, so-called, "plinking" and target shooting on an organized basis should then be encouraged. This last alternative would permit not only a peaceful and orderly society which had confidence in its police but also a "prepared" one.

Again I want to say that what you've done for handgunning, especially of the combat variety, is noteworthy.

Yours,
R.D. West

DEAR Mr. West:

Many thanks for your kind words, and also for your statement of position. I rarely receive mail from a member of a different species, and I find it stimulating. Shooters are almost unanimous in their general views, and talking only amongst ourselves leads us into smugness.

Let us commence with your four categories — target shooting, plinking, self-defense, and hunting.

Target shooting is a valid means of teaching and learning weaponry. The fact that it can be a pleasant sport, too, is an irrelevant bonus. There are plenty of sports. Except as it teaches us how to defend ourselves or to hunt, target shooting's merit can be matched or surpassed by all sorts of non-dangerous activities — from horse shoes to billiards.

Plinking is, in general, a stultifying practice. I am embarrassed to say that I enjoy it, but I cannot approve of it since it encourages sloppy marksmanship. Better to throw rocks.

Now as to defense: You feel that an armed society "undermines the police." I do not follow you here (the Swiss police do not seem to be undermined), but even if I did I would consider the point unsound. The police are useful public servants, but not a sacred institution. If liberty (defined as the optimum balance of freedom and order) dictates that they be "undermined," so be it. I do not, however, understand that to be an unavoidable course.

You might also bear in mind Heinlein's noted dictum that "an armed society is a polite society." We could stand an infusion of politeness.

Your assumption that regulation can provide a "peaceful and orderly" society strikes me as unrealistic — even childish. Peaceful and orderly societies (Iceland,

Switzerland, Tasmania) are the products of tradition, not of legislation. Turbulent and homicidal societies (Ireland, India, New York City) are characterized by despotically repressive laws concerning personal weapons. You advocate total prohibition of private ownership. Do you really think that will protect you from a mugger?

Lastly, there can be no meaningful debate between hunters and non-hunters. The opinions of a non-hunter about hunting are about as valuable as those of a eunuch about sex. Though I consider game far preferable to livestock as food I do not hunt "to support myself." Economic necessity is hardly an ennobling motivation. I do not listen to great music nor read poetry aloud "to support myself." I hunt because hunting is — for me — an emotional need of religious intensity. Your reference to "malice" is incomprehensible. Hunters bear no malice toward game — quite the contrary. If it weren't for hunters, acting in concert, there would be no game. I commend to you the famous essay, "Meditations Upon Hunting," by Ortega y Gasset, available in any good library.

However, hunting may not, and should not be "sold" to the unbelievers. If hunting were a majority pastime there would not be enough to go around. What we can do is politely ask those who do not understand it to shut up about it. I don't understand the mystique of the motorbike, so I keep my mouth shut on the subject.

Again I thank you for "pulling my trigger," as it were. You gave me some rather uncommon targets to hit.

Very truly yours,
Jeff Cooper



SUBSCRIBE TODAY

SOLDIER OF FORTUNE

Magazine

P.O. Box 693
Boulder, CO 80306



Ninja

Ninja Combat System

A Training Manual
\$6.00
P.O. Box 28222 Dept. SF
Atlanta, Ga. 30328

NUMRICH ARMS CORPORATION

NEW

Over 200 Pages

1980

WORLD GUIDE TO GUN PARTS

9TH EDITION

MODERN
MILITARY • ANTIQUE

NUMRICH ARMS, the world's largest supplier of gun parts offers new for 1980, Catalog No. 9 covering a 100 million parts inventory with information never before in print.

U.S. PRICE \$2.95 FOREIGN \$3.95
P.O. BOX SOF 1, WEST HURLEY, N.Y. 12491
PHONE (914) 679-2417 TELEX 145 331

C.I.A. IDENTIFICATION CARD

Exact three color reprint of the S.O.G.I.D. card issued to CIA agents in Viet Nam! This card became famous as the "Get out of jail free" card! The bearer of this card is acting under direct orders of the President. DO NOT DETAIN OR QUESTION HIM! etc. Authentic! Sold as a war relic only! Send \$5.00 Guaranteed!

Devil's Brigade
P.O. Drawer 1, Waskom, Texas 75692

ORIGINAL COLT AR-15 BAYONET

DEPT. SOF

with Sheath, new **\$34.95**

Send \$1.00 for catalog of 100's of surplus items, field equipment, gun accessories, military collectibles.

BROCK'S SURPLUS, INC.

Box 33242, Decatur, Ga. 30033

	<p>PARTICIPANT</p> <p>Southeast Asia War Games 1961-1975</p> <p>SECOND PLACE</p>		<p>BAR/</p>  <p>and /STAR/</p>
 <p>"PEACE THROUGH STRENGTH"</p>		<p>K & L SHIRTS</p> <p>Send Size (S,M,L,XL) and \$7.50 (includes Postage and Handling) to:</p> <p>K & L SHIRTS</p> <p>Box 854, Woodland Hills, CA 91365</p>	

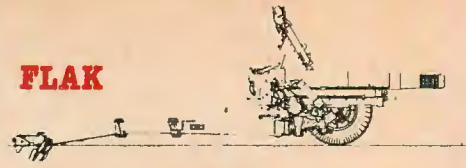

FLAK

Continued from page 85

broke into her apartment house through a back window and sought to gain access to her apartment but ultimately escaped from the roof of the building. After this incident, she consulted me about a self-defense weapon. Consider that she's relatively small, had no experience with guns, wanted something legal, and didn't want to spend a lot of money.

I share SOF's attitude about little .22 and .25 handguns. They simply are not effective, even at close range. In addition, I felt a person needed more experience with a handgun than with a shotgun. In consequence, I purchased a used 20-gauge, single-shot shotgun for \$30, chambered to take a three-inch magnum. Using a pipe cutter, I took off the barrel at 18½ inches and with a file and emery paper smoothed up my work. I then bought three boxes, five shells to the box, Federal, 20-gauge, No. 2 buckshot shells. These run 50 cents per shell and are widely available. One box of five was set aside as the permanent arsenal.

The other two boxes, together with the now-shortened 20-gauge and the lady in question, were taken to a gravel pit. The lady quickly learned to break the gun open, load it, snap it closed, pull back the hammer and fire with the gun held at waist level. Her initial problem was a tendency to "overshoot" as the barrel came up significantly. However, with subsequent firings, this problem was corrected.

It's evident that the unit would sever a leg, and it's to this end that the lady in question has learned to shoot low. (It might sever something else in the process.) She quickly developed adequate if not expert confidence in her weapon. The cost is ridiculously low. I can't imagine even uninformed teenage hoodlums standing up to the barrel of that gun, but if they do, they're certainly going to lose a leg in the process. Also, at close range this unit will take out two, side by side; or one behind the other. Furthermore, it's all legal. Yet when the gun breaks fully into three pieces, it actually could be carried in one of her large purses.

My only mistake was to shorten the stock. I brought it up to the point where little more than the pistol grip is available. This destroyed the gun's balance, making it slightly more difficult to snap it closed. In other words, the only jeopardy is in the snap-close balance, not in the manner in which it is intended to be fired.

Very truly yours,
D.T.
New York, New York

NUNCHAKU

Powerful, but Compact Weapon from the East!

Many times more effective than knives or clubs, even against multiple attacks. Whipping motion afforded by flexible connection between handles yields many times the speed and power of just a straight stick. Patented Swivel-Chain provides smoothness with ultimate strength. Made of Jungle hardwood similar to Teak. African Rosewood models are finished in clear laquer to show off their fine red color. Both hardwood and rosewood models are very strong and hard. All handles taper from 1¼" to 1" at connecting end. 12" lengths are most popular and give a little extra speed. 14" gives a bit more power and reach.



OCTAGON Chain Style Each

NO. 114 - 14 IN., 15 OZ., Black \$8.95

NO. 115 - 12 IN., 14 OZ., Black

NO. 102 - 14 IN., 17 OZ., Rosewood \$11.95

NO. 103 - 12 IN., 16 OZ., Rosewood



ROUND Chain Style Each

NO. 120 - 14 IN., 15 OZ., Black \$8.95

NO. 113 - 12 IN., 14 OZ., Black



Traditional style - No knots showing

OCTAGON Nylon Strung Style Each

NO. 106 - 14 IN., 12 OZ., No finish \$4.95

NO. 107 - 12 IN., 11 OZ., No finish

Nunchaku Carrying Case - No. 134 \$2.95

Black vinyl, zippered case fits all nunchaku.

Book - NUNCHAKU & SAI No. 9090 - \$7.95

By Ryusho Sakagami. Complete nunchaku training manual. Extra clear multiple photo technique shows how to use this amazing weapon.

Throwing Star That Sticks Every Time!

SHURIKEN



NO. 226 \$3.25
NO. 200 \$1.50
NO. 201 80¢

Martial arts throwing knife. Throw like dart. 200 is 4" & 201 is 2-5/8" Both are 1/16" thick & nickel plated. Pro model 226 is 1/8" thick, 3/2" & sharpened. High grade steel.

FREE! SEND FOR YOUR'S NOW

BANKAMERICARD & MASTER CHARGE Accepted for orders over \$20. Give number and expiration date. Sign order same as signature appears on card. **PHONE ORDERS BY CREDIT CARD ACCEPTED.** Sorry, no collect calls. **MONEY ORDER or CERTIFIED CHECK** assures prompt shipment. Personal checks are held for clearance.

SEND YOUR ORDER TO

DOLAN'S SPORTS

Neptune, N.J. 07753
201-922-3382

ADD SHIPPING CHARGES

Orders under \$10—75¢
\$10 to \$20 —\$1.00
Over \$20 —\$1.50

The VINDICATORS . . .

for the times when you want to get even . . .

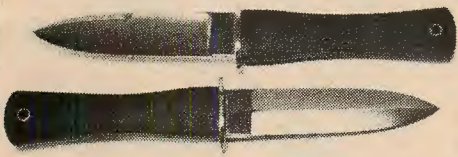

VINDICATORS are handmade of 440C stainless steel, hollow ground, and have a smooth, non-glare finish. The handles are contoured of black micarta and have a stainless steel-lined lanyard hole. The spring lock sheath is black leather and is fitted with a boot/belt clip that is adaptable to an optional shoulder harness.

V-I (single edge) - \$48.00
V-II (double edge) - \$48.00
Optional shoulder rig - \$7.50

ARMAMENT SYSTEMS PRODUCTS, UNLTD.
P.O. Box 18595 · SOF
Atlanta, Ga. 30326



Dealer Inquiries Are Invited

CLASSIFIED



REQUIREMENTS 50¢ per word per insertion, including name and address — Minimum charge \$10.00. Personals are 25¢ per word, \$5.00 minimum. Copy must be accompanied by remittance. Mail to **SOLDIER OF FORTUNE Classified**, P.O. Box 693, Boulder, CO 80306. Insertion will not be made without payment. We reserve the right to delete or change any copy which we determine to be objectionable. Please type or print all ads. We do not furnish proofs. Include name and address in counting number of words. Post office, zip code and state, each counts as words. Abbreviations such as A.P., 20mm, U.S., etc. each counts as one word. Hyphenated words are counted as two words.

GUNS AVAILABLE AT WHOLESALE AND MANUFACTURERS PRICES. Confidential Suppliers List \$3.00. Horton, Box 08332, Milwaukee, WI 53208. (29)

UNUSUAL BOOKS. Silencers, lockpicking, crime, police manuals, bugging and countersurveillance, fake ID, survival, unusual and improvised weapons, life extension, moneysaving opportunities, explosives, self-defense, investigative and undercover techniques, strange philosophies, and much more! We offer the best selection of suppressed information ever put on sale! Unique illustrated catalog only \$1. Loompanics, Box 264, Mason, MI 48854. (30)

HANDCUFFS — Smith and Wesson \$22.50 pair, two \$38.00. Leg Irons \$28.50 set. G. Noramaco, Box 30243-SF, St. Paul, MN 55175. (33)

ISSHINYU KARATE. Over 150 photos and instruction in the Shimabuku System. Send \$3.50 for Long and Wheeler's authoritative *Dynamics of Isshinryu Karate Today*. NATIONAL PAPERBACK PUBLISHERS, Box 146, Knoxville, TN 37901. (TF)

BULLET PROOF VEST — Will stop .44 mag. Fits easily under T-shirt. Officially tested under Department of Defense standards at White Laboratories and Aberdeen Proving Grounds. Send \$1.00 and SASE for complete details and prices. Matthews Police Supply Co., P.O. Box 1754, Matthews, NC 28105. (29)

VIETNAM CATALOG No. 1 (including a free copy of a photo booklet "Vietnam Photos") \$2.00 postpaid. World War II Surplus Catalog No. 7 \$2.00 postpaid. War Shop, Route 1, Box 154, Milford, DE 19963. (29)

MILITARY INSIGNIA AUCTIONS Six times per year. Yearly subscription \$12.00 (U.S.) \$16.00 (foreign). For full particulars write: The Military Auction, 16 W. 331 Jackson St., Hinsdale, IL 60521. (29)

NAZI AND IMPERIAL German insignia for sale. Photo illustrated catalogue \$1.50. Sergeant, P.O. Box 294, Clarendon Hills, IL 60514. (29)

SS AND NAZI MILITARIA. World's biggest catalog, including 2 large posters, \$2 (refundable). KRUPPER, Box 1775F, Syracuse, NY 13208. (32)

GUNS AVAILABLE AT WHOLESALE AND MANUFACTURERS PRICES. Confidential Suppliers List \$3.00. Horton, Box 08332, Milwaukee, WI 53208. (29)

HAND-TO-HAND COMBAT MEANS NO QUARTER — NO MERCY! Now in its second big printing, the Classic Manual, "The Tactical Skills of Hand-to-Hand Combat (Self-Defense)", teaches you how to fight to win in serious, real combat! The FBI, the U.S. Secret Service, the Navy SEALs and the CIA are just a few of the organizations that have received this little gem! \$7 cash or money order payable to Bradley J. Steiner, SURVIVAL-DEFENSE, P.O. Box 7532, Phoenix, AZ 85011. (TF)

"SPECIALTY WEAPONS" I GARROTTE! Wooden handles, prepared for sure-kill grip. Highest-grade wire. "Commando black" for night operations behind lines: \$16. **YAWARA STICK WEAPON!** Thong-grip prevents loss in fight. Illustrated instructions teach vital points, how to use, etc.: \$8. Cash or money order payable to Bradley J. Steiner, SURVIVAL-DEFENSE, P.O. Box 7532, Phoenix, AZ 85011. (TF)

THE TACTICS OF COMBAT HANDGUN SHOOTING. You must read this Special Report if you own a handgun for self-defense! Easy-reading, no frills; just FACTS to keep you and yours ALIVE! \$10 cash or money order payable to Bradley J. Steiner, SURVIVAL-DEFENSE, P.O. Box 7532, Phoenix, AZ 85011. (TF)

ISSHINYU KARATE. Over 150 photos and instruction in the Shimabuku System. Send \$3.50 for Long and Wheeler's authoritative *Dynamics of Isshinryu Karate Today*. NATIONAL PAPERBACK PUBLISHERS, Box 146, Knoxville, TN 37901. (TF)

STAINLESS STEEL LOOP GARROTE, single handed guillotine, \$12.00 postpaid includes a free set of knucks. \$1.00 + SASE for catalog. J.H. Trager, P.O. Box 23174, Detroit, MI 48223. (TF)

BULLET PROOF VEST — Will stop .44 mag. Fits easily under T-shirt. Officially tested under Department of Defense standards at White Laboratories and Aberdeen Proving Grounds. Send \$1.00 and SASE for complete details and prices. Matthews Police Supply Co., P.O. Box 1754, Matthews, NC 28105. (29)

VIETNAM CATALOG No. 1 (including a free copy of a photo booklet "Vietnam Photos") \$2.00 postpaid. World War II Surplus Catalog No. 7 \$2.00 postpaid. War Shop, Route 1, Box 154, Milford, DE 19963. (29)

MILITARY INSIGNIA AUCTIONS Six times per year. Yearly subscription \$12.00 (U.S.) \$16.00 (foreign). For full particulars write: The Military Auction, 16 W. 331 Jackson St., Hinsdale, IL 60521. (29)

NAZI AND IMPERIAL German insignia for sale. Photo illustrated catalogue \$1.50. Sergeant, P.O. Box 294, Clarendon Hills, IL 60514. (29)

SS AND NAZI MILITARIA. World's biggest catalog, including 2 large posters, \$2 (refundable). KRUPPER, Box 1775F, Syracuse, NY 13208. (32)

GUNS AVAILABLE AT WHOLESALE AND MANUFACTURERS PRICES. Confidential Suppliers List \$3.00. Horton, Box 08332, Milwaukee, WI 53208. (29)

HAND-TO-HAND COMBAT MEANS NO QUARTER — NO MERCY! Now in its second big printing, the Classic Manual, "The Tactical Skills of Hand-to-Hand Combat (Self-Defense)", teaches you how to fight to win in serious, real combat! The FBI, the U.S. Secret Service, the Navy SEALs and the CIA are just a few of the organizations that have received this little gem! \$7 cash or money order payable to Bradley J. Steiner, SURVIVAL-DEFENSE, P.O. Box 7532, Phoenix, AZ 85011. (TF)

"SPECIALTY WEAPONS" I GARROTTE! Wooden handles, prepared for sure-kill grip. Highest-grade wire. "Commando black" for night operations behind lines: \$16. **YAWARA STICK WEAPON!** Thong-grip prevents loss in fight. Illustrated instructions teach vital points, how to use, etc.: \$8. Cash or money order payable to Bradley J. Steiner, SURVIVAL-DEFENSE, P.O. Box 7532, Phoenix, AZ 85011. (TF)

THE TACTICS OF COMBAT HANDGUN SHOOTING. You must read this Special Report if you own a handgun for self-defense! Easy-reading, no frills; just FACTS to keep you and yours ALIVE! \$10 cash or money order payable to Bradley J. Steiner, SURVIVAL-DEFENSE, P.O. Box 7532, Phoenix, AZ 85011. (TF)

MONEY SUPPLIED \$\$\$ for your military surplus items; need-ball, A.P., tracer, ammunition, inert ordnance, trip, cluster, and parachute flares, smoke and tear gas grenades, individual equipment, training aids, medical supplies. Send your list and prices with first letter: Ordinance Supply, 4918 Mission Avenue, Dallas, TX 75206, or call 1-214-823-5963. (37)

THOMPSON SUB MACHINE GUN, now you can convert your 27A-1 or 27A-5 Thompson to full auto. No parts to buy, no machining only minor changes done in minutes. Cyclic rate 650 or 1200. Send \$24.95 for instructions to H&H, P.O. Box 296, Pendleton, IN 46064. (37)

CANNON AND HOBBY FUSE, 3/32" diameter, waterproof. 10 feet \$1.00 — 34 feet \$3.00 — 58 feet \$5.00 postpaid. Other goodies. Catalog 25¢. Zeller Enterprises, Drawer W-2X, Wickenburg, AZ 85358. (37)

WANTED: PATRIOTS who see the coming national crises and desire to be prepared. Write for free information to: CHRISTIAN-PATRIOTS DEFENSE LEAGUE or CITIZENS EMERGENCY DEFENSE SYSTEM, Box 565K, Flora, IL 62839 or call 818/665-3937 day or night. Attend free Freedom Festival and Defense System National Conference on 55 acre Estate with over 30 classes in Food, Shelter, Clothing, Defense and Finances. Free camping. Hundreds attended last Festival from 30 states. (29)

ANTI BUGGING DEVICES Locates hidden transmitters fast! Pocket unit alerts you to the presence of a bugging device, checks rooms, autos, phones, people. \$35.00 complete, ready to use. Wynn Engineering Co., Suite 11, 9745 Longpoint, Houston, TX 77055; (713) 464-8170. Catalog of related devices, \$2.00. (31)

LEAFLETS AERIAL propaganda all wars wanted. Please write immediate answer: Klaus Kirchner, D-8520 Erlangen, Luitpoldstrasse 58, West Germany. (29)

JUST PUBLISHED — Catalog/Reference Manual CRM 5-1. Military surplus, survival equipment flight gear, military and outdoor clothing, knives, packs, ALICE and obsolete military field gear, boots, manuals, police equipment, rations, collector's items, etc. Sixty 8½x11 pages, \$1.00 postpaid. No-hassle service and NO JUNK ITEMS. Southeastern Surplus, Inc., Attn: PDO 7228-A Highway 85, Riverdale, GA 30274. (30)

INTRUSION & SECURITY EQUIPMENT designed and built to your requirements. Each design carefully evaluated by our retired Special Forces Colonel who understands your requirements. Free evaluation — SASE. Mobile Engineering, Dept. SOF, P.O. Box 2, Glenside, PA 19038, U.S.A. (29)

JUST PUBLISHED — Catalog Reference Manual CRM5-1. Military surplus, survival equipment, flight gear, obsolete military field gear, boots, manuals, police equipment, rations, collector's items, etc. Sixty 8½x11 pages, \$1.00 postpaid. No-hassle service and NO JUNK ITEMS. Southeastern Surplus, Inc. Attn: PDO 7228-A Highway #85, Riverdale, GA 30274. (33)

MORE NEW BOOKS FROM PALADIN PRESS. Updated and enlarged catalog covering knife fighting, guns, silencers, survival, explosives, self-defense, demolition, guerrilla warfare, field manuals and more. Send \$1.00. Paladin Press, Box 1307-SFC, Boulder, CO 80306. (27/29)

EXECUTIVE PROTECTION. Ex-G.I., 25, Certified combat marksman, seeks employment as bodyguard. Discretion assured. Call (918) 234-3673. (29)

CONVERT M-1 CARBINE TO M-2 (Selective fire); AR-15 to M-16. No machining. Details \$7.50. Catalog of interesting/unusual publications/equipment \$1 (refundable). CDS, Box 3897, Daytona Beach, FL 32018. (31)

MINI 14 SURVIVAL REPORT — tells how to turn the Ruger mini 14 into an even better defensive weapon. Survival/Security Associates, Dept. HG, POB 30753, Seattle, WA 98103. (30)

COVER DOCUMENTATION MATERIALS. Alternate identities, name changes, etc. Law enforcement type I.D. cards, badges, accessories. List \$1 (refundable). C.W.L., Box 3230, Pasadena, CA 91103. (29)

PACK-AWAY BRAND — REAL FREEZE DRIED MEATS. A wonderful addition to your emergency food supply. These products are real meats with no substitutes. Just delicious-fresh tasting Hamburgers, Beef Steaks, Diced Beef, Chicken and Pork Chops. All are nitrogen packed, in enameled #10 cans, with a shelf life of many years. — We believe you will find our Freeze Dried meats to be equal to the finest on the market and our prices the best anywhere. We sell Pack-Away brand meats direct to the public at less than most companies wholesale. — We invite you to write today as we expect a price increase in the near future. — Pack-Away Food Co., Dept. SOF, P.O. Box 847, Napa, CA 94558. (707) 255-3079. (30)

LOCK PICKING, bugging, burglar alarm systems defeat — MUCH MORE! Latest information and professional, GENUINE supplies and equipment — No Rip-Offs — Guaranteed Satisfaction! Send \$2.00 (refundable) for catalogue. NOW WHILE IT'S STILL LEGAL to: L.A.N.D., I.S., 625 Post St., #1048, San Francisco, CA 94109. (30)

"PICK ARTISTS" Large 11x17 blueprints of pin tumbler, disc tumbler, and sidebar locks. Complete detail showing the internal mechanisms. A must for the serious locksmith. All three for just \$5.00 or \$2.00 each. J. Russell, P.O. Box 4566, Pittsburgh, PA 15205. (29)

NEED NEW ID? Get government-issued ID, new credit, better jobs, new life! Complete book catalog 25¢. EDEN PRESS, Box 8410-R, Fountain Valley, CA 92708. (32)

BADGE COLLECTORS Send 75¢ for list of fire and law badges or \$5.00 for next 12 monthly lists. B-PEC, Dept. S.F. 89, 9889 Alondra, Bellflower, CA 90706. (31)

LOCKPICKING MADE EASY — The booklet, **LOCKPICKING MADE EASY**, was written for the beginning locksmith. Unlike the expensive courses, it deals only with opening locks. The book comes with pick and tension tools. Send C.O.D. or \$10.00 check or money order to Tri-Star Security, Box 17, Fabyan, CT 06245. (29)

INTERNATIONAL BROTHERHOOD of Mercenaries invite you to join us now! Are you seeking a life of adventure? Register with other brothers of adventure worldwide. For free information and application form, send self addressed stamped envelope to: I.B.O.M., P.O. Box 5-a, Richboro, PA 18954. (29)

BUY YOUR GUNS WHOLESALE, send \$2.00 for complete list of guns and other exotic defense weapons. Allen's Gun Room, P.O. Box 36, Jamestown, TN 38556. (29)

HIGH QUALITY BRASS KNUCKS \$7.00. Paralyze police units, \$6.95. Allen's, P.O. Box 36, Jamestown, TN 38556. Add 50 cents postage and handling. (29)

FREE JAP WWII RELIC — An arsenal of weapons, captured war trophies, rifle and pistol parts, uniforms, helmets, bayonets, machinegun parts, grenades, bombs, blackpowder weapons, field equipment, knives, Nazi and Japanese relics, numismatic items. Illustrated catalog, only \$5 (refundable). **BONUS** — Free Japanese WWII relic with catalog. McMillan & Co., Box 361-D, Cambridge, MN 55008. (29)

TASER ELECTRONIC DEFENSE WEAPON, all knives, leather goods guaranteed best prices, complete list of these and other exotic defense products \$2.00. Allen's, P.O. Box 36, Jamestown, TN 38556. (29)

NAZI MARCHING SONGS — 3½ hours of music, many songs never heard in the U.S. before. 3 cassettes \$14.95 from: Sons of Liberty, Box 214, Metairie, LA 70004. (30)

HOW FIFTH COLUMNISTS infiltrate and take over governments. Underground facts of the Watergate affair & eight other books only \$10.00. Christian Defense League, Box 493, Baton Rouge, LA 70821. (30)

REVISIONIST BOOKS! Third Reich books! Send SASE for our free booklists: Noonide Press (SF), P.O. Box 1248, Torrance, CA 90505. (33)

COMMUNICATIONS SECURITY FOR TACTICAL OPERATIONS! Signal Security as used by the U.S. Army in Southeast Asia is now available. Code names, authentication tables, and ciphers require no special training or technical knowledge and are not subject to electronic or mechanical failure. Readily adaptable to all communication mediums: wire, wireless, post, or courier, fixed or mobile. Write: TAC-COM, Inc., Dept. 110, P.O. Box 3255, York, PA 17402. (30)

BADGES, CUSTOM MADE to your specifications, top quality, costs \$14 to \$20, send \$1 (refundable), Southwestern Corp., Box 19756, Las Vegas, NV 89119. (30)

MAIL ORDER MAYHEM! A source directory for the unusual: Fireworks, weapons, fake ID, clandestine, much more! \$7.95 plus \$1.00 postage & handling. J.B.S. Enterprises, P.O. Box 35415, Minneapolis, MN 55435 (29)

JANE FONDA GO TO HELL, bumper sticker, also, Boycott Jane Fonda Movies; Support Nuclear Power; Illegal Aliens Go Home. Any combination: four for \$3.00; ten for \$5.00, thirty for \$10.00. Send to: East-West Services, 1717 N. Highland Ave., Suite 701, SF 3, Hollywood, CA 90028. (29)

NAZI SILVER — Captured hoard of large Nazi 2-Mark silver coins minted in Germany from 1933-39, all bearing the infamous swastika emblem. These heavy silver coins are an excellent investment. Dates of our choice. Only \$8.95 each, three for \$25. Silver Bullion Investors, Box 361-D, Cambridge, MN 55008. (29)

BORDER OPS CONSULTANTS. Cargo and personnel expediting. Mexican and Canadian theatres our specialty, but can operate worldwide. P.O. Box 9733, El Paso, TX 79987. (33)

PARACHUTE EQUIPMENT, new/surplus, manufacturer. Official tiger jungle camouflage fabric in stock in cotton poplin & nylon duck, webbings and all related parachute materials. We mfg. & stock camouflage wallets, organizers, belts, watch bands, knife holders. Let us be your parachute broker & round up the equipment you need. International Parachute Supply, Route 13, Brookline, NH 03033. (603) 673-5867. (33)

PRC-6 WALKIE-TALKIES, G.I. mainstay from Korea to Nam. 47.54 MHz FM, less battery. Good working condition. \$17.50 apiece, \$27.50/pair; add \$2.50 shipping. Stephens, Box 591-A, Sandusky, OH 44870. (29)

ATTENTION TEAMS, squads, Special Forces, short run custom belt buckles with your logo my specialty. Solid sandcast sillon bronze, all hand finished. Brochure available. Buckles by Mike, 1225 Manzanita, Dept. SOF, Los Angeles, CA 90029. (29)

WANTED, O.S.S. or S.O.E. weapons, special equipment, suitcase radios, etc. McDonald, Box 2037, Ogden-Utah 84404. (30)

SURVIVE, Perma-Pak and arrowhead mills finest foods and equipment. Long storage, light weight, nutritious, discounts. Large self-addressed stamped envelope. B&T Survival Co., Box 9015, Colorado Springs, CO 80932. (30)

WANTED: PATRIOTS, especially military veterans, who are interested in preparing for the soon-coming political, social, economic, and military disruption of our Country. Write: Christian-Patriots Defense League or Citizens Emergency Defense System, Box 565K, Flora, IL, or call (618) 665-3937, day or night. ACT NOW — TIME IS SHORT. (32)

A HISTORY OF THE WORLD FOUNDATION. Blockbuster story of an ultraright action group. Features polygamy, colonies, mind control, and private armies. Dist. by: R. Hertz, P.O. Box 3085, St. Paul, MN 55165. (29)

DEFENSE PRODUCTS: Ninja knife with belt sheath and shoulder harness. Retail \$45. Sale \$36. Gerber MKI boot knife. Retail \$42. Sale \$36. Puma boot knife. Retail \$72. Sale \$56. Bowmen double-edge belt knife black belt, state size, Retail \$34. Sale \$29. Add \$.50 shipping each knife. Aluminum Knucks 12/\$33, 25/\$55, 50/\$100. Shipping paid. We carry 14 different boot knives, 7 survival knives, 4 belt buckle knives, Knucks, Nightsticks, etc. All below retail list. Illustrated catalog \$1. To: PHMA, P.O. Box 44153, Brooklyn, OH 44144. (29)

CARD PLAYERS — Poker, Bridge, Blackjack, etc. Know WHEN most likely to WIN, most apt to LOSE! Tested successfully in 1000's of hands with 1000's of players. 90 day personal profile \$4.95 — Full year \$14.95. Include date of birth. Profile Marketing, Box 2506, North Canton, OH 44720. (29)

OPEN LOCKED CAR DOORS! This amazing device opens locked car doors fast! Instructions included. Satisfaction guaranteed. \$8.95 to Midcontinental Design, Dept. 19-6b, P.O. Box 2384 Loop Station, Minneapolis, MN 55402. (34)

45 AUTO. 1911-1911A1 muzzle stabilizer, takes the place of barrel bushing. 2½ inches long, 15 holes, located at eleven, twelve and one o'clock \$22.50 each, 3 for \$60.00. Add \$2.00 per order for postage and handling. Ray's Surplus, Inc., 17620 26 Mile Rd., Washington, MI 48094. (31)

CONVERT M-1 CARBINE to M-2 (full auto); AR-15 to M-16. No machining. Complete details \$7.50. MAC M-10 and silencer patent drawings \$10.00 set. Catalog \$1.00 (refundable). CDS, Box 3897, Daytona Beach, FL 32018. (32)

"PICK ARTISTS" Large 11x17 blueprints of pin tumbler, disc tumbler, and sidebar locks. Complete detail showing the internal mechanisms. A must for the serious locksmith. All three for just \$5.00 or \$2.00 each. J. Russell, P.O. Box 4566, Pittsburgh, PA 15205. (29)

A WARRIOR'S RELIGION — Rather be a wolf than a sheep? Into courage, liberty, individualism, family? Maybe the ancient faith of Northern Europe is for you. Asatru's the religion, Odin and Thor two of our deities. We have no master! Asatru Free Assembly, 1766 East Avenue, Turlock, CA 95380. (29)

LAW ENFORCEMENT doesn't pay. former Calif. police officer's skills for sale. Educated, cosmopolitan. Overt/covert, short-term, one-man operations only. You choose method of contact. I'm expensive, but I'm good. Becker, P.O. Box 393, Morro Bay, CA 93442. (30)

LE MERCENAIRE! Monthly newsletter for professionals. Hard intelligence on Terrorism, Communist subversion, Military activities. Sample \$1.00 or \$9.00 per year. \$12.00 overseas. 540 Charles St., Aurora, IL 60506. (39)

A HISTORY OF THE WORLD FOUNDATION. Blockbuster story of an ultraright action group. Features polygamy, colonies, mind control, and private armies. Dist. by: R. Hertz, P.O. Box 3085, St. Paul, MN 55165. (29)

WANTS TO LEARN hand-to-hand combat, knife fighting, merc & bodyguard tricks and tactics. J.L., P.O. Box 25218, Chicago, IL 60625 (30)

JUST \$15? We want your business! We'll send you: Original G.I. mess kit with knife, spoon and fork. Original G.I. issue can opener. Original G.I. issue canteen. Late issue G.I. C-Ration dinner (delicious!). Plus free \$5 gift certificate... and illustrated catalog on U.S. military surplus camping and hunting gear. Entire package, only \$15. RATIONS, Box 172-D, Anoka, MN 55303. (30)

SUBS — Instructions to make full automatic. Colt .45 M1911 \$12.95, Llama .45 or 9mm \$8.95, Llama 380 or 32 \$7.95, Saver M38 \$12.95, Ruger 10/22 \$12.95, Mauser HSC \$9.95. All plans \$69.95. Reply: RANDOM, Box 2515, Columbus, OH 43215. (30)

WW II GERMAN NEWSREELS of the great battles, rare pre-war films, allied documentaries and features on Super 8 sound film and video cassettes. Send stamp for free brochure. International Historic Films, P.O. Box 29035, Chicago, IL 60629. (31)

SILENCERS, PATTERNS and PRINCIPLES \$10.95. Law Enforcement Guide to Firearms Silencers \$3.50, Silencers for Hand Firearms \$10.95, Firearms Silencers

\$6.60, Six Old Silencer Catalogs \$3.50, How to Build Silencers \$3.95, Quiet Killers \$6.00, Silencers, Snipers and Assassins \$17.55. Catalog \$1.00. Money order only. Survival Books, Dept. SOF, 11106 Magnolia Blvd., North Hollywood, CA 91601. (213) 763-0804. IN STORE OR BY MAIL. (30)

COLLECTING MILITARY MEDALS? United States, Nazi, European, Oriental. Large illustrated catalogue \$2.00. (Refundable with purchase). Reuben E. Jenkins, P.O. Box 1359, Columbus, GA 31902. (30)

INTERNATIONAL PERSONAL PROTECTION. Travel anywhere anytime. Contact Special Confidential Service (SCS), Box 5581, Boise, ID 83750, call (208) 343-0139 (Professional). (29)

SURVIVE FAMINE U.S./Steel Co. 16 gallon steel barrels- airtight excellent for weapons, food, clothing storage. Perfect for your underground stash \$19.95 add \$2.00 shipping & handling. Excluding Alaska & Hawaii. Prairie Fire, 10609 Commerce Ave., Tujunga, CA 91042. (30)

SELECTLINE CATALOG HOLDERS: VALOR #0373 now \$25.00 postpaid! Purchase \$50.00 or more and get one Kershaw Chum FREE!! Both offers expire: 02-29-80. Attach AD to Order Form

FEAR NO PAIN OR INJURY! Learn G-Jo, first aid of the Samurai. New in America. 115 secret pressure points, easily mastered, takes only minutes to learn with our program. So effective G-Jo stops even severe pain, bleeding immediately. Be up and fully functioning within moments of injury. Also promptly relieves headaches, indigestion, burns, stings, backaches, etc. A vital skill for survivalists and others far from doctors, drugs. Hundreds of testimonials — G-Jo really works! Complete program (illustrated handbook, cassette tape, newsletter, wallchart): \$22.00. Handbook, alone: \$10.50. Full 30 day guarantee. G-Jo, Box 8060-Z, Hollywood, FL 33024. (31)

SAVE ENERGY & MONEY, shop by MAIL! Send \$3.00 for your AIRMAILED copy of our brand new, 52 page, Volume No. 4 CUTLERY CATALOG. Liberally photo-illustrated covering 18 brand names & over 200 models of the world's finest. Everything from Hackman BALISONG'S, AES Bayonets, to Dicyclohexylammonium Nitrite!! Save up to 35% off list prices w/our exclusive Catalog Discount Program. Take advantage NOW of our monthly SOF specials & giveaways. Your Satisfaction Guaranteed!! SELECTLINE, Box 3915F, P.C., Hawaii 96782.

NEEDED few good mercenary thinking type people for clandestine type work for liberal payment. Contact Jack Hayes, 823½ 23rd Street, Orlando, FL 32805.

ATTENTION SOF READERS! Send us \$16.95 & we'll AIRMAIL you the world's lowest priced, Hollow-handle SURVIVAL/COMBAT Knife anywhere!! Crafted by the renowned "AES" firm of A. EICKHORN Solingen & issued to the Austrian Army. SPECIFICATIONS: 6½" Saber-ground, Forged Bayonet Steel blade, 3/16" thick, & chemical-blackened, w/indestructible, Fiberglass embedded, POLYAMID handle & scabbard. Satisfaction Guaranteed!! SELECTLINE, Box 3915F, P.C., Hawaii 96782. ("AES" Photo-Catalog \$1.00).

SECESSION 1985 — A real man's state. Free catalog. The Spengler Group. P.O. Box 3085, St. Paul, MN 5565. (31)

NIGHT VISION SCOPES! First and second generation units available from (2) of the developers of night viewing devices. Send \$2.00 for brochures and pricing. Satellite Enterprises, Inc., P.O. Box 2207, St. Augustine, FL 32084 (32)

KILL OR BE KILLED. Train with professional expert (15 yrs. exp.) in lethal methods of close quarter hand-to-hand combat and self-defense. Tough no-bullshit training results guaranteed. These programs are second to none. For brochure send \$3 to Charles Hoffman, 64 Main St., Tuckahoe, NY. (30)

FANTASTIC TRAINING MANUALS! Authored by Pro for you! Learn investigative techniques, agent recruitment and handling, surveillance and countersurveillance, protective services, counterterrorism tactics, undercover techniques, much more! Some topics exclusively published by COUNTERPLOT, Box 62 (SOF), Hyde Park, NY 12538. Catalog \$1.00. (31)

COMBATANT KNIFE-RAZOR FIGHTING. Train with professional expert (15 yrs. exp.) in complete combatant use of knife-razor. Ruthless offensive-defensive techniques taught for street or field combat situations. Beginner-advanced programs. For brochure send \$3 to Charles Hoffman, 64 Main St., Tuckahoe, NY Results guaranteed. (30)

BUGGING, PHONE PHREAKING: Project Kits complete with ALL needed components, easy to follow instructions, much more! Send \$1.00 for most fascinating catalogue of 'Confidential' electronic devices available anywhere. T.O.N.T.I. Systems, 537 Jones St., No. 8816, San Francisco, CA 94102. (32)

FUNDAMENTALS OF COMBAT PISTOLCRAFT. New Jersey — N.Y.C. — Philadelphia Area Only. N.P.I. is now

accepting applications for the instruction of qualified students in the basic practical skills of modern defensive pistolcraft. For information and application, send \$1.00 to: Northeast Pistol Institute, P.O. Box 453, Union, NJ 07083. (33)

LOCATE, URGENT: Maj. John "Mike" Brower last known as Killen, Tex. Contact ASAP Cpt. B. Fitzhugh, P.O. Box 1967, Texarkana, TX 75501. Employment waiting. URGENT.

CUSTOM KNIFE BROKER — fighters — boot — folders — hunters — over 100 currently in stock — Why Wait? — R & C Knives, P.O. Box 32631, San Jose, CA 95152 — (408) 923-5728. (30)

CARLOS: PORTRAIT OF A TERRORIST \$5.00. Assassination in our time published at \$14.95, now only \$6.95. Men Against Tanks: A History of Anti-tank Warfare, \$5.95. For all new 1980 Killzone catalog, send \$1.00 to: Killzone, P.O. Box 513, Warrnsburg, MO 64093.

NIGHT VISION SCOPES! First and second generation units available from (2) of the developers of night viewing devices. Send \$2.00 for brochures and pricing. Satellite Enterprises, Inc., P.O. Box 2207, St. Augustine, FL 32084.

SUPER MIND POWER SECRETS (KI). Data (stamp). MH, 22511 Markham, Perris, CA 92370. (30)

FIGHTING-HUNTING KNIVES: 112 Randall variations, Bagwell, Crawford, D'holder, Pardue, Ruana, Wilson, List prices. Catalog \$1.00. Kenefick, 19 Leander, Danielson, CT 06239. (32)

MERC FOR HIRE: Anything, anywhere if the price is right. Send description to P.O. Box 5311, Falmouth, VA 22401. (30)

.45 SMG PLANS — Complete construction blueprints \$7.00. Explosives, silencers, etc. Send stamp for list. Jaguar, Box 3892-S, Cocoa, FL 32922.

DEERHUNTERS WANTED! The Vietnamese parlor game is available to those who crave more than armchair excitement... Enjoy America's newest adult game more than combat! \$5. SAIGON ENTERPRISES, Box 40842, Fayetteville, NC 28304.

WANTED — Merc or any type work. Veteran, licensed pilot, skydiver, scuba diver. Ex-peace officer, will travel anywhere. Phone 826-4087. Grandy, 1706 Seneca St., Buffalo, NY 14210. (30)

CONCEALABLE BODY ARMOR stops the .44 magnum. Weight 2 1/2 lbs. Free Brochure. Write: SES (SF-2), 60 Madison Street; Geneva, NY 14456. (32)

COLLECTING MILITARY MEDALS? Large, illustrated catalogue of United States, Nazi; worldwide — \$2.00. Reuben E. Jenkins, P.O. Box 1359, Columbus, GA 31902. (31)

USMC Vietnam combat veteran, parachutist, wants action, have passport, will travel anywhere on short notice. Call Don (913) 462-6065.

Ex-ARMY/LAWMAN says law enforcement doesn't pay. Overt/covert/protection/operations. Will join group or work alone. You choose method of contact. Terry, Box 554, Stratford, TX 79084.

EX-MARINE OFFICER — platoon leader in Vietnam, 13 months combat, current passport. Wants hazardous overseas employment. Write D. Morton, 1131, Summer Sun, Colby, KS 67701.

MINI-14 Selective fire conversion plans; complete parts specifications and installation instructions. Only \$19.95 sent First Class! Rainier, Dept. SF, 2420 1st Ave., No. 12, Seattle, WA 98121. (31)

FREE DETAILS. Deadly fighting skills, powerful muscles, mind-body power secrets. Freeliffe, Box 1124, Garden Grove, CA 92642. (31)

1980 BRITISH SURPLUS, 8 page list of current surplus, \$1.00 or 50¢ and previous catalog cover. A.H.A., P.O. Box 21606, Denver, CO 80221.

BECOME PART-TIME GUN DEALER! "Obtaining Federal Firearms License," samples, illustrations (New Edition) \$1.95. "Gun Dealer's Directory of Wholesalers" 3 vital directories in one — \$1.95. "Selected Federal Firearms Laws". Top authorities answer most asked questions, \$1.95. All three booklets — only \$4.95! MESA, Drawer 9045-FM, Steamboat Springs, CO 80477.

SUBS — Convert your Ruger 10/22 to full auto. No parts needed. Send \$9.95 to Random, Box 2515, Columbus, OH 43216. (31)

VIETNAM CERTIFICATES OF DECORATIONS. Cross of Gallantry or Campaign Medal certificate. Original form. (Not a photocopy.) Printed in four colors. Suitable for framing. \$3.00 each, both for \$5.00 postpaid. John Berendsen, 909 Noah Dr., St. Louis, MO 63135.

AN/PRC 6 Gov't. issue walkie talkies. \$210 for two. Send \$210 to Random, Box 2515, Columbus, OH 43216.

HOMEMADE MORTAR can be constructed of easily obtainable parts. Send \$5.95 to Random, Box 2515, Columbus, OH 43216. (31)

WIRETAPPING AND EAVESDROPPING Countermeasure techniques explained in new report. Discusses series and parallel taps, transmitters, and the various hookswitch bypasses and rewiring attacks used to compromise phones. Cost \$9. Additional reports available on telephones, countermeasures sweeps (details and actual excerpts \$1). COUNTERTEK, Box 5723, Bethesda, MD 20014.

SURVIVE THE COMING CRUNCH. Send \$9.95 for the Overkill report to Random, Box 2515, Columbus, OH 43216. (31)

ENTREPRENEURIAL LAWYER wanted to take an active role working with an international businessman in developing various new ventures, projects, and other profitable opportunities. Nature of association open, depending upon your interests, present commitments and financial needs. A resume is essential, but it must be accompanied by a letter selling me on you. Tell me about yourself, your goals, and why you seek this opportunity. Your response will be held in strictest confidence. Box 5474, New York, NY 10017.

USMC — Current issue camo caps. \$9.95 to Random, Box 2515, Columbus, OH 43216. (31)

COMBAT AND IPSC SHOOTERS! Jones Extended Magazine Release for Colt .45 Autos. Fast release of magazine! Large, non-slip stainless steel, checkered button. Easily installed. Detachable. Instructions included. \$19.95 postpaid. N.Y. residents add 7% sales tax. Overseas add 50¢. Jim's Flye Shoppe, R.D. No. 1, Fredonia, NY 14063.

QUARTERLY MERCENARY REGISTER — Newest newsletter in the profession tells How, Where and Who to apply to. Subscription rates are \$24.00 annually. Send to Random, Box 2415, Columbus, OH 43216. (31)

ISRAELI PARATROOPS EQUIPMENT & INSIGNIA. We have just come back from Israel and brought back many items never offered before. Send. 50¢ for our list. A.H.A., P.O. Box 21606, Denver, CO 80221. 5 Israeli para berets, with insignia, for sale to the highest bidder, one or all!

PRIVATE INVESTIGATION Career. Learn the secrets of crime detection! Complete training based on California private investigators licensing examination. Write for FREE information. Shaw Investigation, P.O. Box 716M Provo, UT 84601 (California license No. A5235). (31)

FRENCH FOREIGN LEGION BERETS, with insignia. We picked these up while in Europe. New in assorted sizes. Only \$23.00 each. A.H.A., P.O. Box 21606, Denver, CO 80221.

U.S./IRISH DUAL with active Dutch wife. Last twelve years Europe based in Marine charter, overland and photo safari including No. Africa, Mid-east, Scandinavia and Iron Curtain. Ex-Military Survival Officer five years, expertise: 6,000 hours light aviation, master sailor, heavy background in self-sufficiency, survival and bush experience, hand guns and self-defense. Non-smokers or drinkers. Personable, yet low-profile. Multilingual. References. Seek short or long term contract to instruct, operate or associate in any or all of above areas where professionalism is appreciated. Taylor Box 1422, Fulton, TX 78358. (30)

TURKISH MALE, 26, seeks position. Anything considered. Abdul, 537 Jones St., No. 8838, San Francisco, CA 94102.

MUSCLE SIZE AND POWER! Strengthen and build the worlds greatest fighting machine — your body. Send \$5.00. Page Enterprises, 314 17th St., Suite 638, Oakland, CA 94612

ESP WARFARE, hypnotism techniques. Public Relations Counsel, A. John Tiger, Box A, Lucerne, CA 95458. (38)

EMERGENCY RESERVE food supply of 2 weeks or more has 12 different freeze dried foods in No. 2 1/2 cans. Compact unit weighs 11 lbs. Shelf life over 10 years. Only

\$49.95 plus \$2.50 for UPS. Or send S.A.S.E. for free listing of other reserves for longer periods. B-Prepared Supply Co., Box 248S, Vienna, OH 44473.



THE PARALYZER STOPS Muggers, Molesters and Rapists ...

YOU CANNOT PURCHASE A SAFER STRONGER, MORE EFFECTIVE TEAR GAS OR CHEMICAL DEVICE.



(Size 4" x 3/4")

- The "PARALYZER" has been editorialized on NBC, CBS and ABC television, in national newspapers and magazines, as a precision protective instrument that will instantly stop even a 300 lb. man up to twenty minutes. No permanent injury to assailant. Has twice the strength of competitive devices; will not clog.

- Fits in pocket or purse.

- Fires 50, one-second blasts up to a distance of 8 feet.

GET YOUR "PARALYZER" Send \$4.95 plus \$.50 postage Our "SPECIAL OFFER" three for \$13.35. We pay shipping Check or Money Order.

(OHIO RESIDENTS ADD 4% SALES TAX)

TO: PATCO ENTERPRISES
P.O. BOX 5006 — DEPT. SF
CINCINNATI, OHIO 45205

WHOLESALE LOCKSMITH SUPPLIES

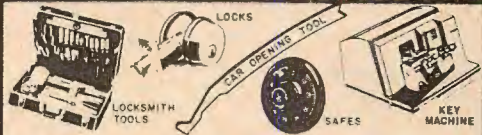

ORDER YOUR GIANT CATALOG



jam packed with the latest in Locksmith Tools Key Machines, Key Assortments, Deadbolts, Foreign Car Key Blanks, complete line of Safes, Closed Circuit TV Systems, Alarm Systems, High Security Locks, Electronic Lock Card Systems, I.D. Cards, Technical Manuals, Code Machines, and much, much more! National's Your One-Stop Locksmith Supply Supermarket. Most orders shipped within 24 hours We welcome locksmiths, student locksmiths and industrial accounts. To order National's catalog send \$5.00 (refundable after first purchase of \$25.00 or more) Your catalog will be rushed to you by first class mail!

NATIONAL LOCKSMITH SUPPLY
P.O. BOX 31598, DEPT. SF, DALLAS, TEXAS 75231

TYPE TRP

For Small Frame (5-Shot) Revolvers
And Medium Frame Semi Automatics



To order, enclose \$14.00 plus \$2.00 for shipping and insurance to:



ARMAMENT SYSTEMS PRODUCTS, UNLTD.
P.O. Box 18595-SOF, Atlanta, Ga. 30326

TIGHTROPE

This unorthodox style of carry was introduced in the late 1950's and has enjoyed some popularity in certain circles. In the times when concealment is more desirable than speed of draw, yet weapon accessibility is critical, the TIGHTROPE may satisfy your priorities. The weapon is presented to the hand at an angle that is natural for a palm-out grip and withdrawal. Careful attention to the details of engineering, combined with custom hand finishing, overcomes the obvious limitations inherent in a design of this nature.

When ordering, please designate: the weapon to be carried; color choice (black or tan); for right or left hand draw.

**SPECIAL
INTRODUCTORY OFFER
ONLY \$6.00**

**NEVER BEFORE PUBLISHED
Vital Info - Completely Illustrated
PURCHASE PROCEDURES
MUCH - MUCH - MORE
A MUST for Avid Weapons Enthusiasts**

**SUB-MACHINE GUN
GUIDE**



\$6.95

SEND: \$6.00 CASH, CERT. CHECK, M.O.
Includes Postage and handling

**TO:
PERISCOPE PUBLICATIONS
DEPT. S F
P. O. BOX 1637
MILWAUKEE, WI 53201**

**CAF AIRBORNE
MEMBERSHIP INFO**

The CAF's 1st Airborne Division seeks new members. Ground school, harness training and first jump can still be had at a reasonable price. Publisher Brown is a member and claims the camaraderie alone is worth the dues. Write the Confederate Air Force, First Airborne Division, Rebel Field, Harlengen, TX 78550.

**SUPPORT
SOF**



ADVERTISERS

NAZI S-S Officer's Belt Buckle

Hand finished in fine silver plate (with fasteners modified to fit any 1 3/4" belt). Only \$12.00 postpaid. Our New 224 page fully illustrated relic collectors catalog = \$2.00 free with order.



**W.W. #2 Ltd.
Box 2063 Dept. F
St. Louis, MO 63156**

ADVERTISER INDEX

Advertiser	Page
Aesores Technicos	88
Al Markives	82
American Mailing	80
American Pistol Institute	10
AN/COM Electronics	19
Armament Systems Products	75,83,84 87,90,93
B&M Enterprises	84
Beinfeld Books	77
Best Sports Supplier	84
Bianchi Gun Leather	11
Bravo Yankee	84
Brigade Quartermaster	14,75,88
Brock's Surplus	89
Cobra	83
D&E Magazine Mfg.	13
Desert Publications	2,80
Devils Brigade	89
Dolan's Sports	90
Eden Press Inc.	88
Eleventh Hour	96
Florida Conservative Union	79
FTL Marketing Corp.	87
H&H Firearms	10
Ken Hale	86
Heckler & Koch, Inc.	8,9,62
Horizone	85
House of Weapons	83
K&L Shirts	90
The Larder	83,86
Loom Panics Unlimited	81
MacMillan Publishing	95
Military Book Club	3
Military Graphics	94
National Alliance Book Service	85
National Locksmith Supply	93
Ninja	89
North American School of Firearms	85
Paladin	63
Parallex Corp	6
PATCO	93
Periscope Publications	94
Personal Defense	82
Phoenix Assoc.	15,29,78,95
Police Science Institute	7
Quimtronix	86
RMS	18
Samisdat	76,79
Sentinel Arms Corp.	4
Shadow Systems	20,75,81
Sherwood International	Inside Cover
SOF	16,28,89
South African Report	86
Southeastern Surplus Inc.	21,87
Survival Books	85
TBN Enterprises	80
Tel-Test	84
Tiffen International	20
J.H. Trager	88
TYCO	83
USI Corporation	88
Unique Imports	80
Viet American	84
Viet Nam War	1
Western & Rocky Mtn. Arms	85
World War II Products	88,94
Worldwide Publishing	17

MILITARY GRAPHICS

Box 9671-Dept. 3
Baltimore, Maryland 21237 U.S.A.

"Our 5th Year Serving the
Fighting Man Around the World"

Worlds Largest Selection of Military Insignia Sportswear

All Insignia Redesigned

- | | |
|----------------------------------|---------------------------------------|
| No. | No. |
| 1. U.S. Special Forces | 16. British Parachute Regt. |
| 2. U.S. Marine Corps Insignia | 17. British Royale Marines |
| 3. British Commando | 18. Waffen SS Runes |
| 4. U.S. Master Airborne Wings | 19. SS Deaths Head |
| 5. U.S. Senior Airborne Wings | 20. Scottish-Blackwatch |
| 6. U.S. Novice Airborne Wings | 21. Viet-Nam—Airborne Wings |
| 7. U.S. 101st Airborne | 22. U.S.M.C. Drill Instructor |
| 8. U.S. 82nd Airborne | 23. 5th Special Forces Group |
| 9. U.S. Marine Corps Recon Wings | 24. 101st Air Assault |
| 10. Rhodesian Airborne Wings | 25. Explosive Ordinance Disposal |
| 11. U.S. Navy S.E.A.L. Insignia | 26. U.S. Army Ranger Insignia |
| 12. Rhodesian Security Force | 27. Special Forces—Special Operations |
| 13. British Special Air Service | 28. British—Long Range Desert Group |
| 14. French Foreign Legion | 29. Rhodesian Selous Scouts |
| 15. French Commando | 30. Special Forces—Mike Force |

Specify Shirt Type • Color • Style • Insignia No. • Shirt Sizes, Small—Medium—Large,—X-Large

T-SHIRTS \$7.50

Colors Available
White, Blue, Tan,
Gold, Green, Scarlet

RING NECK - T-SHIRTS \$8.50

- | | |
|-------|----------------------|
| Style | Body Color/Trim |
| A. | Lt. Green—Drk. Green |
| B. | White—Drk. Green |
| C. | White—Blue |
| D. | Gold—Black |
| E. | Lt. Blue—Drk. Blue |

Larger Facilities to serve

- | | |
|-----|----------------------------|
| No. | You Better |
| 31. | Devils Brigade—Airborne |
| 32. | 10th Special Forces Group |
| 33. | Luftwaffe Eagle |
| 34. | Rhodesian African Rifles |
| 35. | Loval Scouts—Scottish |
| 36. | Grenadier Guards—British |
| 37. | Royal Scots Greys—Scottish |
| 38. | Scottish Rifles |
| 39. | Irish Guards—British |
| 40. | Fallschirm-Jager—Germany |
| 41. | L.R.R.P.—Airborne |
| 42. | 1st Cav.—Airmobile |
| 43. | Wild Geese—Airborne |
| 44. | Royal Scots Fusiliers |
| 45. | R.A.F.—Pilots Wings |

SWEATSHIRTS \$10.50

Colors Available
White, Blue, Green,
Gold, Gray, Scarlet

CHECK MONEY ORDER VISA MASTER CHARGE

Orders outside the U.S & Canada, add 20% to prices for Air-Mail Delivery

Please Allow 4-6 Weeks Delivery

Credit Card Orders—Include all Numbers on Card

AWARD CERTIFICATES

* \$8.00 each 3 for \$15.00 *

* Space for Name/Rank/Dates *

- | | | | |
|----------------------------------|----------------------------------|---------------------------------------|--------------------------------------|
| * 8x11 in Color * | C-1 U.S.M.C.—Force Recon | C-7 Special Forces—Guerrilla Warfare | C-13 Rhodesian—Parachute Regt. |
| C-2 U.S. Special Forces | C-2 U.S. Special Forces | C-8 Special Forces—Weapons Expert | C-14 U.S. Navy S.E.A.L.—Weap. Expert |
| C-3 U.S. Navy S.E.A.L. | C-3 U.S. Navy S.E.A.L. | C-9 Rhodesian Security Force | C-15 5th Special Forces Group |
| C-4 U.S. Airborne—Master | C-4 U.S. Airborne—Master | C-10 U.S. Marine Corps—Weap. Expert | C-16 U.S. Marine Corps—Rifle Expert |
| C-5 U.S. Army Ranger | C-5 U.S. Army Ranger | C-11 U.S. Airborne—Senior | C-17 U.S. Marine Corps—Pistol Expert |
| C-6 Special Forces—Jungle Expert | C-6 Special Forces—Jungle Expert | C-12 Special Forces—Demolition Expert | C-18 U.S. Army—H.A.L.O. |

FOR LARGER SELECTION OF INSIGNIAS AND PRODUCTS—SEND \$1.00 FOR OUR ALL NEW 1980 CATALOG

MERC: AMERICAN SOLDIERS OF FORTUNE

JAY MALLIN
and ROBERT K. BROWN

NEW!

An eye-opening account of the lives, ideals, and adventures of today's soldiers of fortune.

Many of them were trained as Special Forces in Vietnam. Few of them do it for the money. They're idealists, romantics, dyed-in-the-wool adventurers. They fight in Africa, South America, the Far East — wherever their expertise, experience, and courage have a value. These are today's "mercs," and now a former *Time* correspondent and a Vietnam veteran/adventurer-turned-publisher profile these men — many of whom they have known personally — and the danger-fraught world they inhabit. Rogues and heroes, soldiers and CIA agents — they all share a lust for adventure that drives them to danger and often, early death.

JAY MALLIN is a former *Time* correspondent and author of seven books on unconventional warfare and terrorism. ROBERT K. BROWN was a Special Forces team leader in Vietnam; he is presently the editor/publisher of the controversial magazine *Soldier of Fortune*.

Published by MacMillan **\$14.95**
Hardcover

Numerous black & white and color photographs



Each copy of MERC will be autographed by Robert K. Brown

COMING SOON FROM PHOENIX MERCENARY LEADERS GUIDE, Vol. I

SOF MILITARY EDITOR
CAPT. JOHN EARLY

NEW!

This is it; the book you have been waiting for!

There has never been a comprehensive field manual for Merc operations until now. Capt. John Early, who has been a professional soldier for more than 15 years both in the uniformed conventional services and under contract, has written a reference work for the mercenary combat leader, giving pertinent data for organizing and leading troops in the field.

This book is a collection of current military techniques practiced by elite airborne commando units around the world and techniques Capt. Early developed and used successfully on the battlefields of Southeast Asia and Africa.

A reference manual for those who are already combat leaders, and a how-to manual for those who want to lead, it's a must for any combat library.

Is it worth the price? How much is a successful operation worth? **\$7.95**

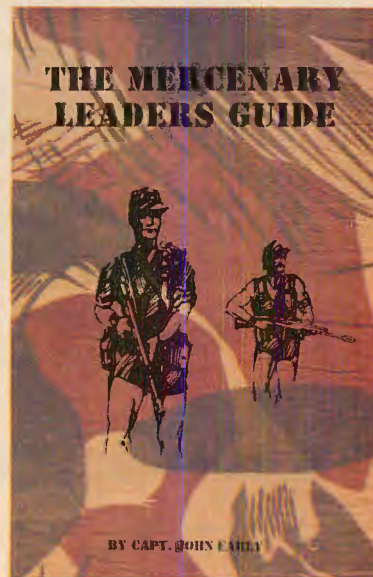

NOW!



NOW!



NOW!

YES! Rush Me The Following:

NAME _____

ADDRESS _____

CITY _____

STATE _____ ZIP _____

PHONE _____

- Copies of Merc: American Soldiers of Fortune \$14.94 ea.
 - Copies of Mercenary Leaders Guide, Vol. I \$ 7.95 ea.
- Colorado residents add 3% sales tax

PHOENIX ASSOCIATES

Dept. SF-4 Box 693
Boulder, Colorado 80306

Add \$1.00 shipping charges per order.

Overseas orders, surface \$2.00 airmail \$7.00.

If not satisfied, return books in 10 days for full return of your money.

A distinguished four-star general speaks out:

IT'S NOT TOO LATE TO SAVE OUR COUNTRY FROM NUCLEAR DESTRUCTION.

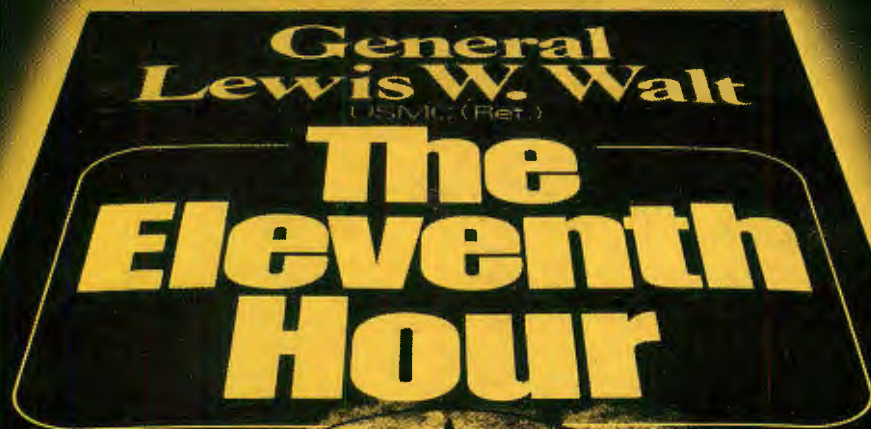

BUT WE'D BETTER HURRY.



Your President hasn't told you. The Department of Defense hasn't told you. The press hasn't told you. General Walt's urgent message may come as a terrible shock. Here are facts so important you cannot afford to be without them. Facts once available only to Presidential advisors and top brass. Facts our muzzled military cannot discuss without risking General Singlaub's fate in Korea. It's a book you and all your friends *must* read if you are to plan for the future.

You're invited to examine *The Eleventh Hour* for 15 days on an absolute, no-strings-attached money-back guarantee. If you decide the book is not *one of the most important you've ever owned*, just return it within the 15 days, and we'll refund your \$9.95 in full, no questions asked.

At least, you'll know the names of the men responsible for the coming nuclear war.

Send \$9.95 for THE ELEVENTH HOUR plus 75¢ for postage and handling, a total of \$10.70, to:

SOLDIER OF FORTUNE
Box 693 - Dept. Adv.
Boulder, CO 80306

account no. _____ expiration date _____
name _____
address _____
city _____
state _____ zip _____

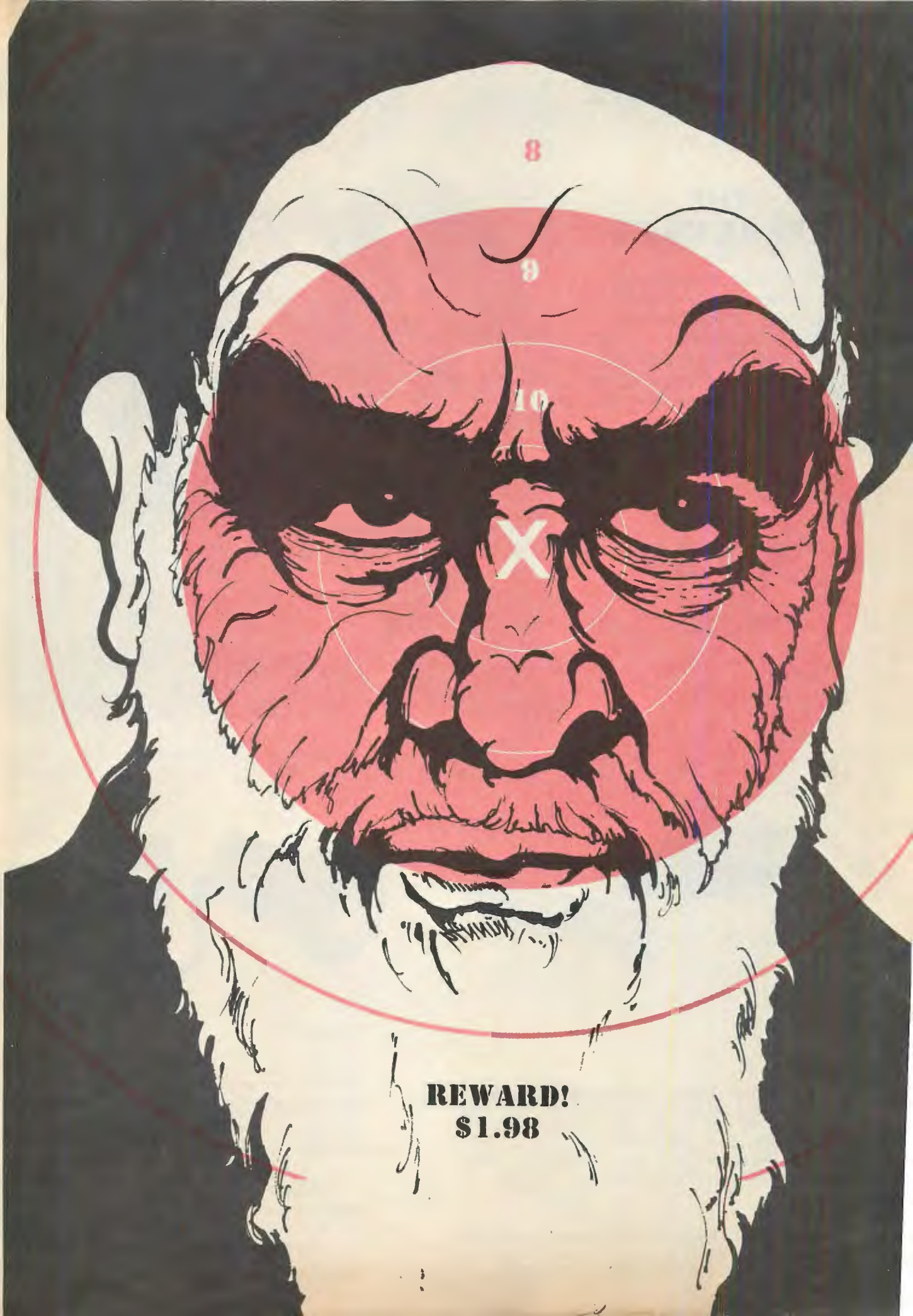

REWARD!
\$1.98

PHOENIX

THE TEKNA KNIFE

Weight is 5 oz.; overall length is 7½ inches with ¼ inch thick stainless blade having a Rockwell hardness of 57-59. The sheath is ABS plastic injection moulded with a spring loaded one handed ambidextrous thumb release. The straps are Velcro with auto spring loaded tensioning buckle.

PRICE

\$34.95

Plus \$1.25
Postage and Handling
Dept. SF-24

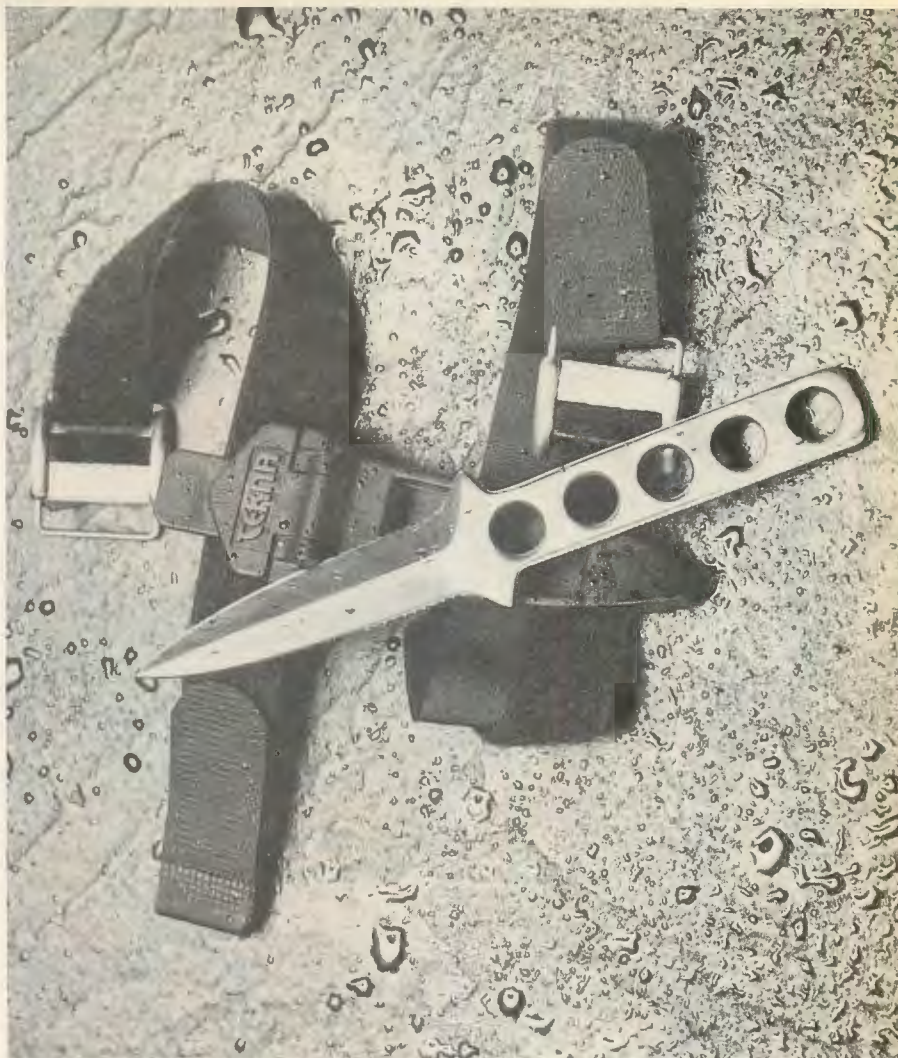

TEKNA-LITE II

5.5" long, 1.125" diameter pocket light weighs only 4 oz., yet runs 4 hours on 2 AA Alkaline cells. Fool-proof rotating lens switch with virtually indestructible ABS and polycarbonate body. 1300 candlepower white light output is unmatched for its size. Completely waterproof to 2000 feet. **\$9.95**

Dept. SF-26

HOLDER

2" long neoprene holder with conveniently adjustable Velcro Strap allows light to be mounted on arm, ankle, dashboard or backpack. **\$4.95** Dept. SF-27



TEKNA-LITE I

5.5" long, 9 oz. rechargeable NiCad powered light can be recharged 1000 times. Nearly indestructible ABS and polycarbonate body takes up only 15 cu. inches, yet has the same 4000 candlepower output of a 4-cell flashlight twice its size. Its Nickel Cadmium batteries provide over an hour burn time in -40°-250° temperatures. Waterproof to 2000 feet. **\$34.95** Dept. SF-28

VISA
Mastercharge

Overseas Orders add 20%
Colo. Residents add 3%

P.O. Box 693,
Boulder, Colo. 80306

Include \$1.00 for Postage and Handling.

Allow 3-4 weeks for delivery. MONEY BACK GUARANTEE





SHERWOOD'S WORLD of BAYONETS and SCABBARDS



Sherwood International is the exclusive U.S.A. distributor for A. Eickhorn...the world's most famous manufacturer of Military Bayonets and Scabbards.

<p>SI-1  COLT AR-15/M16 Bayonet & Scabbard \$24.95</p> <p>Blade length: 7" Features: Wire cutter, razor back saw blade, belt attachments, sure-grip handle and tie-thongs.</p>	<p>SI-2  COLT AR-15/M16 Bayonet & Scabbard \$26.95</p> <p>Blade length: 7" Features: Bottle opener, wire cutter, razor back saw blade, belt attachments, sure-grip handle, and tie-thongs.</p>	<p>SI-3  COLT AR-15/M16 Bayonet & Scabbard \$31.95</p> <p>Blade length: 10" (Long) Features: Wire cutter, razor back saw blade, belt attachments, sure-grip handle, and tie-thongs.</p>	<p>SI-4  COMBAT KNIFE with Scabbard \$21.95</p> <p>Blade length: 7" Features: Wire cutter, razor back saw blade, belt attachments, sure-grip handle, and tie-thongs.</p>	<p>SI-5  COMBAT KNIFE with Scabbard \$27.95</p> <p>Blade length: 10" (Long) Features: Wire cutter, razor back saw blade, belt attachments, sure-grip handle, and tie-thongs.</p>					
<p>SI-6  SWISS SIG Bayonet & Scabbard Model 510-4 7.62 NATO \$24.95</p> <p>Blade length: 7" Features: Wire cutter, razor back saw blade, belt attachment, sure-grip handle, and tie-thongs.</p>	<p>SI-8  M4 CARBINE BAYONET with M8A1 Scabbard \$15.95</p> <p>U.S. Caliber .30 M1 Carbine Blade length: 6 1/2" Features: Belt attachment, sure-grip handle, and tie-thongs.</p>	<p>SI-9  M5A1 GARAND BAYONET with M8A1 Scabbard \$17.95</p> <p>U.S. Caliber .30 M1 Garand Rifle Blade length: 6 1/2" Features: Belt attachment, sure-grip handle, and tie-thongs.</p>	<p>SI-10  COLT AR-15/M16 M-7 BAYONET with M8A1 Scabbard \$15.95</p> <p>Blade length: 6 1/2" Features: Belt attachment, sure-grip handle, and tie-thongs.</p>	<p>SI-11  COMBAT KNIFE M3 Bayonet with M8A1 Scabbard \$13.95</p> <p>Blade length: 6 1/2" Features: Belt attachment, sure-grip handle, and tie-thongs.</p>					
<p>SI-12  G-3 RIFLE* (HK 91/93 Norwegian Model) Bayonet & Scabbard \$21.95</p> <p>Blade length: 6 1/2" Features: Belt attachment and sure-grip handle. *(NOTE: Bayonet adapter for rifle is separate. See item #SI-20.)</p>	<p>SI-13  G-3 RIFLE* (HK 91/93) Bayonet with M8A1 Scabbard \$21.95</p> <p>Blade length: 6 1/2" Features: Belt attachment and sure-grip handle. *(NOTE: Bayonet adapter for rifle is separate. See item #SI-20.)</p>	<p>SI-14  G-3 RIFLE* (HK 91/93) Bayonet & Scabbard \$27.95</p> <p>Blade length: 10" (Long) Features: Woodgrain scabbard, belt attachment and sure-grip handle. *(NOTE: Bayonet adapter for rifle is separate. See item #SI-20.)</p>	<p>SI-15  COMBAT AUSTRIAN ARMY Knife and Scabbard \$11.95 \$11.95</p> <p>Blade length: 6 1/2" Features: Bottle opener, belt attachment and sure-grip handle. Colors: SI-15 O.D. Green SI-16 Black</p>	<p>SI-17  BELGIUM FAL Bayonet & Scabbard \$29.95</p> <p>Blade length: 6 1/2" Features: Belt attachment.</p>					
<p>SI-18  GERMAN ARMY MK III Boot Knife & Scabbard \$15.95</p> <p>Blade length: 5" Features: Quick release safety snap, belt attachment, sure-grip handle, and leather scabbard.</p>	<p>SI-19 Not shown NEW COLT AR-15/M16 Bayonet with M8A1 Scabbard Blade length: 6 1/2" Features: Wire cutter, razor back saw blade, belt attachment, sure-grip handle, and tie-thongs. (NEW ITEM. Photograph was unavailable at time of printing) \$21.95</p> <p>SI-20 G-3 Adapter \$5.95 G-3 Adapter for SI-12, SI-13 and SI-14 for attachment of bayonet to rifle.</p>	 <p>Example of the wire cutting capabilities of the world famous Eickhorn bayonet. This feature available with the following models: SI-1, SI-2, SI-3, SI-4, SI-5, SI-6 & SI-19.</p>							
<p>SI-7 COLLECTORS PRESENTATION CASE 6 different Bayonets & Scabbards are ready for your display. A must for every collector! Each case contains 1 each of the following:</p> <p>SI-1 COLT AR-15/M16 Bayonet & Scabbard Blade length: 7" Features: Wire cutter, razor back saw blade, sure-grip handle, and tie-thongs.</p> <p>SI-10 COLT AR-15/M16 Bayonet & Scabbard Blade length: 6 1/2" Features: Belt attachment, sure-grip handle, and tie-thongs.</p> <p>SI-3 COLT AR-15/M16 Bayonet & Scabbard Blade length: 10" (long) Features: Wire cutter, razor back saw blade, belt attachment, sure-grip handle, and tie-thongs.</p> <p>SI-4 COMBAT KNIFE Bayonet & Scabbard Blade length: 7" Features: Wire cutter, razor back saw blade, belt attachment, sure-grip handle, and tie-thongs.</p> <p>SI-11 COMBAT KNIFE Bayonet & Scabbard Blade length: 7" Features: Belt attachment, sure-grip handle, and tie-thongs.</p> <p>SI-5 COMBAT KNIFE Bayonet & Scabbard Blade length: 10" (long) Features: Wire cutter, razor back saw blade, belt attachment, sure-grip handle, and tie-thongs.</p> <p>\$142.95</p>					<p>CALL TOLL FREE 800-423-5237</p> <p>Minimum Order \$10.00 Call Toll Free. 800-423-5237 (except Calif.), Mon. through Fri., Only - 9 to 5.</p> <p>This service is available ONLY to holders of major credit cards! B. of A., VISA, M.C., American Express, Carte Blanche, Diners Club.</p> <p>Simply tell the order taker what you want, give credit card number and we'll ship your order.</p> <p>For technical information, etc., call our executive offices, No. 213-349-7600. Dealers & Jobbers write (don't call) for quantity discount schedule.</p> <p>EASY TO ORDER!</p> <ol style="list-style-type: none"> Send Cash, Check or Money Order. Please include estimated postage, insurance & handling minimum \$2.00 with each order. Foreign Orders, incl. min. \$4.00 postage with order. All products can be purchased by mail. Minimum order \$5.00 Calif. res. add 6% SALES TAX. All inquiries not accompanied with self-addressed stamped envelope will not be answered. All major credit cards accepted. NO C.O.D.'s. <p>Card No. _____ Expr. Date _____ Name _____ Address _____ City _____ State _____ Zip _____ Signature _____</p> <p>Sherwood International 18714 Parthenia Street, Dept. SF 3 Northridge, California 91324</p>				



Prepared for National Media by Bear Advertising, Inc.

SD-879-M31

UNIT



NINE



NEW **COMBAT:** **House-to-house**

—by Terry Edwards. Edited by J.W. Burns. Photos by Gary Flanagan. Combat in the streets. Close-up, dirty and deadly. Combat: House-to-House is the latest in Unit Nine's how-to books, and possibly the best yet. How to attack, how to defend. House-clearing. Weapons and tactics. Barricades to vehicles. How to move, how to fight, how to stay alive and how to WIN! Combat: House-to-House doesn't deal in terrorism or political theory. It is a manual of city combat and it won't leave you hanging with vague or incomplete instructions. Must reading for any potential combatant, tactician or police tactical unit. Over 200-pages, over 100 photos and illustrations. \$6.95 plus postage and handling (see below).

PLUS TWO MORE NEW TITLES

THE BLOODY CONGO — by David Logan. Few areas on earth can match the savage history of the Congo. Logan cuts through the myths and confusion and lays out the facts. The sadistic excesses of tribal chiefs, the murders, the massacres, the exploits of the famed White Legion, and the murderous incompetence of the United Nations, are all detailed. This book will enrage and horrify. It is the story of a country the free world abandoned to anarchy in the name of freedom. 130-pages, over 50 photos. \$5.45 plus postage and handling (see below).

GRENADES! — by Mike Weber. Edited by G.W. Winnington-Ball. A new generation of weapons has given new meaning to the word grenades. Here is what they are all about. How they work, how to use them. From the exotic impact and electronic fused marvels, through shaped charges, rocket propulsion, frag and blast, old and new, domestic and foreign. Grenades! is put together as only a professional can do it. For collector, historian, and of course, THE USER! 130-pages, over 80 photos and illustrations. \$5.45 plus postage and handling (see below).

STILL AVAILABLE

MERCENARY'S MANUAL PART ONE — by Terry Edwards. Photos by Gary Flanagan. The book on surviving in combat. Packed with how-to stuff that might make the difference between coming back in one piece and not coming back at all. Compact and realistic. Tactics, camouflage, small arms, grenades, individual security and plenty more. 132-pages, 5 1/2 x 8 1/2, illustrated and with lots of photos. Still \$4.95 plus postage and handling (see below).

MERCENARY'S MANUAL PART TWO — by Terry Edwards. Edited by Robt. K. Brown. Photos by Gary Flanagan, Al Venter and others. Like Part One, Part Two is a manual to be USED. For example the first chapter covers portable rockets, missiles and recoilless weapons used by the infantry. Not just what they are or how they work, but how to fire them as well. Twenty weapons are covered, and that is only one chapter of the 16 in the book. From improvisations to tracking to demolitions, mortars, mines, airborne and waterborne techniques, field fortifications, recon, urban warfare and much more. Part Two is the book on taking the war to the enemy! It's up front and up-to-date. 328-pages, 5 1/2 x 8 1/2, over 150 photos, many illustrations. \$8.95 plus postage and handling (see below).

POSTAGE AND HANDLING CHARGES — All books are mailed separately. 1st Class includes Air Mail. We advise Parcel Post within North America, and 1st Class for foreign orders. To order, list books or books desired and calculate the postage according to the figures here. State clearly whether you want 1st Class or Parcel Post. Don't forget your return address!

For **MERCENARY'S MANUAL PART ONE, THE BLOODY CONGO, and GRENADES!**
Parcel Post inside North America 60¢ — outside North America \$1.00
First Class inside North America \$1.00 — outside North America \$1.80

For **COMBAT: HOUSE-TO-HOUSE or MERCENARY'S MANUAL PART TWO**
Parcel Post anywhere \$1.00
First Class inside North America \$1.60 — outside North America \$3.00

We now accept ChargeX, Bank Americard, Visa and MasterCard. To order include your card number (including the four digits below your name on MasterCard) expiration date and signature on separate paper. OR, you can phone your charge card order to 416-661-5344 during business hours. Sorry, no COD's.

Send to: **UNIT NINE, 1110 FINCH AVENUE WEST, DOWNSVIEW, ONTARIO, CANADA M3J 2T2**